



ITQB

and the
Laboratório Associado
on the Oeiras Campus

Laboratório Associado

Chemistry

Biology

Biological Chemistry

Technology

Plant Sciences

2004|2005

ANNUAL REPORT
and **PLAN**

2005 PhD PROGRAM IN CHEMICAL AND BIOLOGICAL SCIENCES

The CBS PhD program

Advanced training in modern chemistry and biology

PhD degrees in Biochemistry, Biology, Chemistry, and Chemical Engineering

Formal training in techniques and methodologies

Faculty from basic and applied sciences: Structural Biology, Genetics and Molecular Biology, Functional Genomics, Physiology, Cellular and Developmental Biology, Plant Sciences, Pharmacogenetics, Green Chemistry, Organometallic Chemistry and Catalysis

Coordinators: Luis Paulo N. Rebelo, Adriano O. Henriques, Cláudio M. Soares

The ITQB-UNL

State of the art facilities

Modern equipment: NMR, EPR and RAMAN spectrometers, X-ray diffractometer, biological imaging, computational resources, advanced fluorescence equipment and Pilot Plant

Support services: protein microchemistry, mass-spectrometry, elemental analysis, small molecule X-ray crystallography

47 research groups

5 Divisions: Biological Chemistry, Biology, Plant Sciences, Chemistry, and Technology

c.a. 125 PhD holders, over 100 PhD students, 300 researchers

and including:

Biotechnology companies installed in-house

Associated Laboratory status

More information

CBS PhD program, c/o Ana Maria Portocarrero
Planning and Academic Division
ITQB-UNL

Av. da República, Apartado 127
2781-901 Oeiras
PORTUGAL

Tel: (351 21) 4469316
Fax: (351 21) 4411277
Email: cbs@itqb.unl.pt
WEB: www.itqb.unl.pt

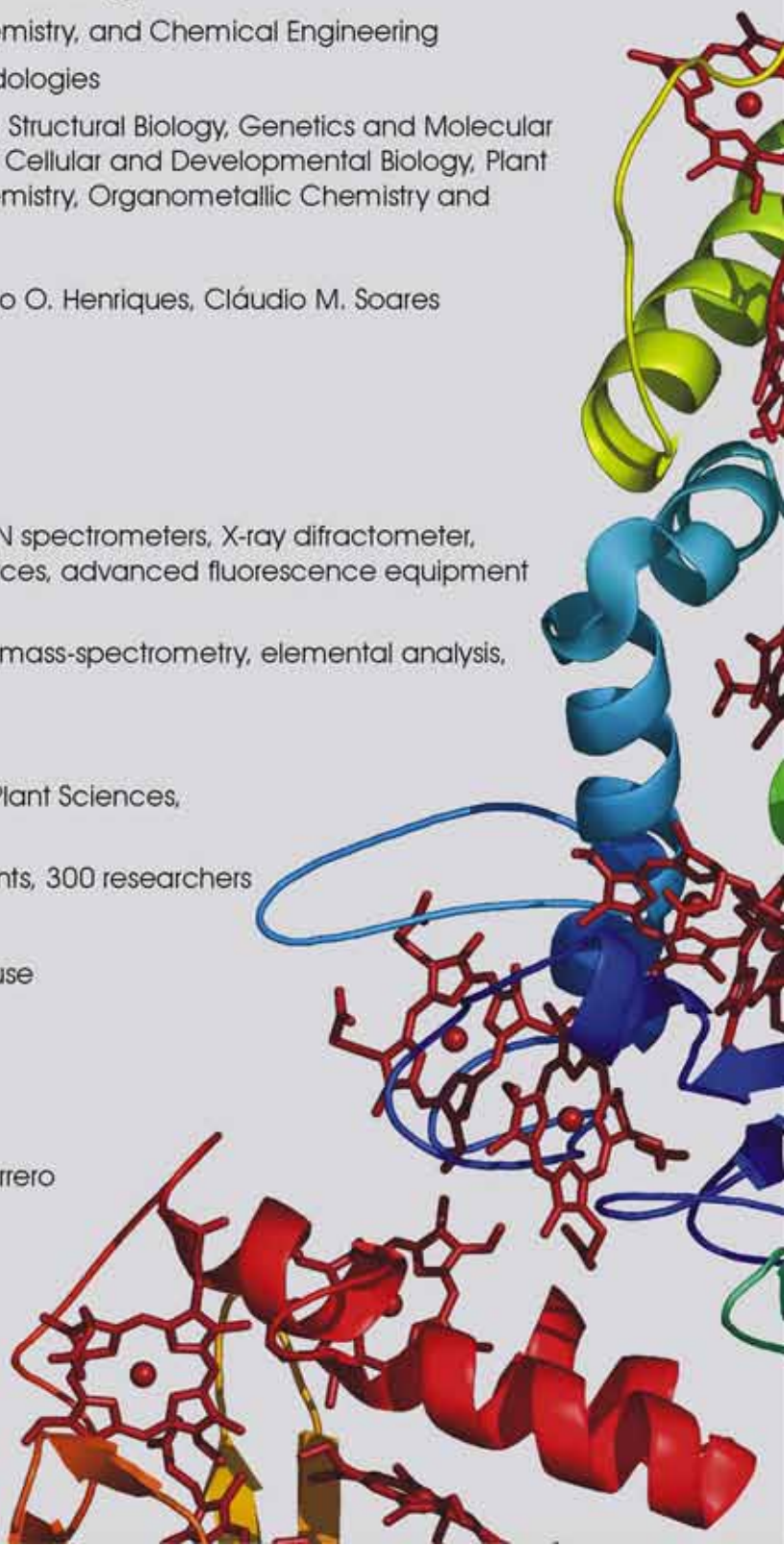

INTRODUCTION BY THE DIRECTOR.

Welcome to the Annual Report and Plan 2004/2005. This Report comprises the scientific activities of the Instituto de Tecnologia Química e Biológica (ITQB), the major academic scientific activities of the Instituto de Biologia Experimental e Tecnológica (IBET), and the activities of the scientists employed under the Laboratório Associado contract working at these two Institutes and the Instituto Gulbenkian de Ciência (IGC), over the period April 2004 to March 2005. Further details of the activities of all three Institutes can be obtained from the web pages listed at the end of this introduction.

Once again the year has been one of stark contrasts, financial doom and gloom coupled with scientific excellence and some brand new initiatives in the area of science communications. On the financial side the ITQB has been removed (temporarily) out of the Orçamento de Estado budget of the Universidade Nova de Lisboa and transferred to PIDDAC funding. It is pleasing to report that this transition appears to have worked smoothly, although the size of this part of the overall budget is still insufficient to cover the infra-structure support requirements. A hard battle was fought to try and get a realistic increase in the Orçamento de Estado component, but after several promising indications the Institute was met with complete intransigence from the Ministry for Science and Higher Education. This was very disappointing since the ITQB's case was firmly based on the growth of activity commensurate with the ambitious research program in the Life Sciences and related areas that it undertakes, and the ratio of the Orçamento de Estado component to the overall budget. An increase of some 38% is required to bring the Orçamento de Estado budget back to the equivalent level of 2000. Be assured that the ITQB will be taking up this battle again over the coming year! With respect to the Laboratório Associado budget, the supply of funding has also been problematic, although I would once again like to record my public thanks to Professor Ramôa Ribeiro and his colleagues at the Fundação para a Ciência e a Tecnologia. The FCT has tried to help whenever possible and the actions taken have undoubtedly kept the Institute operational in a very difficult financial year. At the time of writing, the LA contract for 2003-5 is under re-negotiation, but I am optimistic that the outcome will be favourable and that the situation for this year will be much improved from the previous two years. There is also the prospect of the finalization of the various major equipments grants for which applications were made in 2001. The Laboratório Associado bids have been strongly recommended and supported and, for example, the ITQB will acquire an 800 Mhz High-field Nuclear Magnetic Resonance Facility during the period 2005-6. My congratulations to my predecessor, Professor Manuel Nunes da Ponte and all the scientists who assisted him in formulating the 2001 Major Equipment Bid.

Despite all the financial problems the ITQB has not only survived, but also maintained a very high standard of productivity to the benefit of Portuguese science and technology. The reviews of the ITQB Divisions by independent panels of external experts have now been completed; Professors Joachim Klein (Braunschweig), Daniel Wang (MIT) and Manuel Mota (Minho) for Technology and Professors Pat Heslop-Harrison (Leicester), Evert Jacobsen (Wageningen) and Engineer Serafim Tavares (RAIZ) for Plant Sciences. The Laboratório Associado has also been successfully reviewed by panels appointed by the Fundação para a Ciência e a Tecnologia in the areas of Health Sciences and Chemistry and Biology. The general scientific ambience and the favourable reviews are a great credit to all the staff, scientists, technicians, administrators and everyone else who help in the running of the Institute.

Highlights of the scientific program are presented elsewhere in this Annual Report and are ordered according to the research undertaken by scientists specifically employed on the Laboratório Associado contract, followed by the five ITQB Divisions.

The year 2004-5 has also seen our scientists being formally recognized for their research excellence and expertise. Within the Laboratório Associado 7 scientists from ITQB, 1 from the IBET and 2 from the IGC were awarded “Prizes of Excellence” by the Minister for Science and Higher Education. The qualifications for these prizes were very stringent including a high number of publications and citations and the supervision of PhD students. In reality only those scientists who have actively pursued research at an international level over a number of years were recognized under the conditions set, and it is a great tribute to the prize winners that they were able to achieve these in a country where the funding for scientific and technical research has been very limited. It is to be hoped that this scientific and technical prowess is properly acknowledged by the Funding Bodies in Portugal. In addition to the Prizes of Excellence, individual scientists have continued to win international recognition through invitations to give plenary lectures at international conferences, being awarded prizes for the best poster presentations, and participating in the organization of scientific meetings. My congratulations go to all these scientists, but it would be remiss not to mention one of the Vice-Directors of the ITQB, Professor Maria Arménia Carrondo, who was awarded the EUROBIC medal for 2004. This is a very prestigious award and further details of this and other awards can be found later in this Report.

It is also with great pleasure that I can report that Professor Joachim Klein has recently been awarded the Degree of Doctor *Honoris causa* by the Universidade Nova de Lisboa for his contributions to science and technology in ITQB, IBET and the UNL over the past twenty years. A brief account of his work is also presented in this Report.



The Laboratory received a number of visitors including the Rector of the Universidade Nova de Lisboa, Professor Leopoldo Guimarães and the Chinese Vice-Minister for Science and Technology, Professor Den Nan. The picture above depicts the Chinese Vice-Minister for Science and Technology surrounded by her colleagues presenting a plaque of the Great Wall of China to the ITQB Director.

The year 2003-4 also saw the continuation of the special Laboratório Associado lectures and the Joint ITQB/ISA lectures, lists of which are presented later in the Report. Other events included a very successful workshop entitled BioCrys 2004 as part of the European MAX-INF Network in macromolecular Crystallography. This workshop, involving several international experts, included two superb lectures by Anders Liljas (Lund, Sweden) on the structure and function of ribosomes, the protein manufacturing machinery of living cells.

In terms of science communication, one of the many important aspects of the Laboratório Associado program, the ITQB organised two very different, but eminently successful events. The first involved the young people of the Oeiras locality with the assistance of the Oeiras Câmara in June 2004. Children between the ages of 6 and 10 were asked to complete a phrase saying why they wanted to be a scientist and to make a drawing of how they envisaged a typical scientist at work. Some 250 entries were received and caused considerable amusement and entertainment among the organising committee. I do hope that that one particular Oeiras family did not discover one morning that a younger sibling had been turned into a frog! Overall the drawings were of a very high standard and some 20 of the “winners” were invited to spend an afternoon at the ITQB doing experiments as well as having their efforts publicly displayed at the Oeiras Fete and within the ITQB.

The second was a “Dia Aberto” for the ITQB in January 2005, whereby the local Oeiras community was invited to visit the Institute and find out exactly what we are trying to achieve. The ITQB was overwhelmed to receive some 860 visitors who showed a very encouraging interest and enthusiasm for the research that we are doing. We received many positive comments such as; the Government should give you proper support, you must continue to have these open days on a regular basis, we never realised how much you are contributing to improvements in the quality of life, you should have open days every 6 months, you should have a whole week not just one day, and please can we come back tomorrow since after 4 hours we still have not seen it all! It really was a tremendous success and clearly indicates the interest that the Portuguese have in modern science and technology.

For both events, and other public relation initiatives, my very sincere thanks are due to the hard core of organizers, Margarida Archer, Ana Sanchez, Paula Alves, Ana Rute Neves, Teresa Crespo and António Lopes and their colleagues, for their very skilful organization, the motivation that they gave to their colleagues, and the tremendous amount of effort and enthusiasm that they invested in a very professional manner. A special mention should also be made of Luís Morgado for his beautiful design work on the various poster and other displays. I believe that the local community are beginning to fully appreciate the science and technology developments to improve the quality of life and the environment, that are being undertaken in their midst and that they will give us their support in the future.

I must also comment on future teaching activities. The predominant function of the ITQB is to undertake research in the Life Sciences and related areas as one of the Centres of Excellence within the Portuguese network of science and technology. However, the ITQB also recognizes that it must get involved in teaching at the intermediate level between the first and third stages of the Bologna system if it is to continue to attract research students and workers of sufficient caliber

to undertake its ambitious research program. The crucial requirement is to get the students working at the bench within an established research team and to inspire them with the desire to continue their research at the PhD level. The ITQB does not see its role as teaching extensively within the first cycle courses; these are the province of the other Faculties who are far better equipped and experienced in this regard. There are a number of teaching initiatives that are being developed for courses at the so-called +2 level and details of these will no doubt appear in future reports. A fly-leaf describing the current CBS teaching program, a mandatory course for all first year PhD students, is shown elsewhere in this Report.

There are many other exciting matters on which I could comment in this Report, but I will leave the reader to form their own judgement from the contents which follow this introduction. I am optimistic about the future. Funding will probably always present problems in Portugal, and indeed elsewhere in Europe, and to undertake high quality fundamental and applied research will require strong mindedness and persistence. However, if institutes such as the ITQB and its Laboratório Associado can be properly supported, Portugal will have the young scientists with the knowledge, enthusiasm and all the characteristics that are needed to undertake the high quality research of the future, and this in turn will lead to the creation of national wealth and employment.

Finally I would like to acknowledge the help of my Vice-Directors, Maria Arménia Carrondo and Miguel Teixeira, for their efforts in helping me to direct this large and very active institute and to Margarida Martinez and Luís Morgado for their considerable help in preparing this report.



Peter F. Lindley
Director, ITQB-UNL.

March 2005.

Instituto de Tecnologia Química e Biológica

<http://www.itqb.unl.pt/>

Instituto de Biologia Experimental e Tecnológica

<http://www.ibet.pt/>

Instituto Gulbenkian de Ciência

<http://www.igc.gulbenkian.pt/>

ORGANIZATION OF THE INSTITUTE

DIRECTORATE

- Peter F. Lindley - Director
- Maria Arménia Carrondo - Vice-Director
- Miguel Teixeira - Vice-Director (from July 2004)

SCIENTIFIC ADVISORY COMMITTEE (Coordinating Committee of the Scientific Council)

- Management
 - Peter Lindley, Chairman, (Director)
 - Maria Arménia Carrondo (Vice-Director)
 - Miguel Teixeira (Vice-Director)
 - Margarida Martinez (Secretary to the SAC until July 2004)
 - Ana Maria Portocarrero (Secretary from July 2004)
- Chemistry Division
 - Carlos Romão
 - Eurico Melo
- Biology Division
 - Adriano Henriques
 - Helena Santos
- Biological Chemistry Division
 - Miguel Teixeira (until September 2004)
 - Claudina Pousada (from September 2004)
 - Cláudio Soares
- Technology Division
 - Luís Paulo Rebelo
 - Teresa Crespo
- Plant Sciences Division
 - Cândido Pinto Ricardo
 - Margarida Oliveira
- Substitutes
 - Júlia Costa
 - Cecília Arraiano
- Ex-Officio Members
 - António Xavier
 - Manuel J.J.T.Carrondo
 - Manuel Nunes da Ponte

INTERNATIONAL ADVISORY COMMITTEE

- Professor Sir Tom Blundell FRS, Biochemistry Department, University of Cambridge, UK.
- Professor Joachim Klein, Institute of Macromolecular Chemistry, Universität Braunschweig, Germany
- Professor Chris Leaver, Department of Plant Sciences, University of Oxford, UK.
- Professor Staffan Normark, Swedish Foundation for Strategic Research and Department of Bacteriology, Karolinska Institute, Sweden.
- Professor Karl Wieghardt, Max-Planck-Institut für Bioanorganische Chemie, Mulheim, Germany.

INFRA-STRUCTURE SUPPORT COMMITTEE

- Maria Arménia Carrondo - Vice-Director (Chairman)
- Peter Lindley - Director
- Mafalda Mateus - Secretary
- Rosário Mato - ITQB-I
- Henrique Campas Nunes, Nuno Monteiro - Safety; Workshop & Maintenance
- Maria da Glória Leitão, Madalena Pereira, Fernando Tavares - Administrative & Accounting
- Carlos Frazão, Carlos Cordeiro; Daniel Branco - Computing & Networks
- Margarida Senna Martinez, Lurdes Conceição - Planning and Academic
- Miguel Teixeira, Susana Lopes - Library
- Manuela Regalla – Washrooms and Services
- Ana Coelho - Services

SAFETY AND FLOOR COORDINATION COMMITTEE

- Abel Oliva - Chairman
- Peter Lindley - Director
- Maria Arménia Carrondo - Vice-Director
- Mafalda Mateus - Secretary
- Henrique Campas Nunes – First Floor
- Maria da Glória Leitão, Madalena Pereira, Fernando Tavares – Second Floor
- Lúgia Saraiva Teixeira – Third Floor
- Abel Oliva, Luís Paulo Rebelo – Fourth Floor
- Teresa Crespo– Fifth Floor
- Cândido Pinto Ricardo, Margarida Oliveira– Sixth Floor
- Carlos Romão, Rita Delgado – Seventh Floor
- Rosário Mato, Ricardo Louro – ITQB-I
- Cecília Arraiano, Adriano Henriques – Radioactive Sources
- Teresa Crespo, Júlia Costa – Biological Hazards
- Helena Santos, MD - Medicine and Health
- Helena Matias - Safety adviser
- Isabel Ribeiro -IBET representative
- António Cunha – Pilot Plant Representative
- Henrique Campas Nunes, Nuno Monteiro – Workshops & Maintenance

LIBRARY

- Susana Lopes

INFRA-STRUCTURE SUPPORT SERVICES

ADMINISTRATIVE AND ACCOUNTING SERVICES

Head: Maria da Glória Figueira Gonçalves Reis Leitão

Administrative Department Coordinators

- Fernando Jorge Dias Tavares
- Maria Alexandra Ferreira Lopes Pinto dos Santos
- Maria Madalena Albuquerque Marques Pereira

Personnel Section

- Ana Luísa da Silva Teixeira Cruz
- Goretti Anjos Gomes da Rocha
- Helena Isabel Gomes Cordeiro Rodrigues
- Maria Cristina Pereira Pinto

Mailing and Archive

- Ana Sofia Marques de Sousa Mendes – part time
- Artur Elias dos Santos Freitas
- Felicidade Jesus da Silva Rei

Accounting

- Ana Cristina Afonso Silva
- Ana Mónica Adriano Vieira
- César Paulo da Mata Simões
- Isabel Maria Soares Palma Mestre
- Nuno Miguel Nobre Lopes

Treasury section

- Ana Dores dos Santos Freire
- Anabela dos Santos Bernardo Costa

Stores

- Ana Isabel Soeiro Jesus Francisco dos Santos
- Bruno Alexandre Lucas Gouveia
- Carlos Eduardo Branco de Matos Aires Martins
- João Augusto Lourenço Rodrigues
- Ricardo Manuel Pereira Pinto

Secretariat

- Ângela Mafalda Faria Baptista Mateus
- Isabel Cristina Respício Valente Almeida Lopes
- Maria de Fátima da Costa Madeira

PLANNING AND ACADEMIC DIVISION

Head : Margarida Maria de Freitas de Senna Martinez

- Ana Cristina Porfírio Amaral
- Ana Maria Cerveira e Castro da Silveira Portocarrero
- Luís Morgado
- Maria de Lurdes Madaleno Conceição

WORKSHOP AND MAINTENANCE

Head : Henrique José Vaz de Campas Nunes

- Alexandre Saturnino Largo Maia
- Aníbal José Neves Ribeiro
- António Veiga Ramalho
- Custódio José de Campos
- João Carlos Zanão Simões
- José Luís Pereira Liberato
- Luís Miguel Sousa Gonçalves
- Rui Hélder Amor Pereira Dias

Power management

- Nuno Monteiro

WASHROOMS FOR EQUIPMENT

- Ana Cristina Martins Barreiros
- Carmen Popula Pereira de Jesus Fernandes
- Isilda Marques Martins Gueifão
- Maria Alice Rosa Ferreira
- Maria Eugénia Ferreira Pereira dos Santos
- Pilar da Conceição Lobo da Costa Campos
- Sónia Cristina Capucho Serrano

COMPUTER SYSTEMS SUPPORT

- Carlos Manuel Cordeiro
- Daniel Feliciano Branco
- Isabel Baia
- Maria Manuel Paulo Rato
- Miguel Loureiro
- Miguel Ribeiro

ANALYTICAL SERVICES

- Ana Maria de Jesus Bispo Varela Coelho : Mass Spectrometry
- Maria da Conceição Lucas Carvalho Pereira de Almeida : Elemental Analysis
- Maria Manuela Sobral Martins Alberto Regalla : Protein Sequencing
- Paula Maria Gonçalves de Oliveira Roldão Chicau : Amino Acid Analysis
- Isabel Bento : Small Molecule X-ray Crystallography

FERMENTATION AND PROTEIN EXPRESSION LABORATORY

- João Nuno Carichas Carita

RESEARCH STATISTICS

RESEARCHERS

The following tables indicate the numbers of Ph.D. holders and graduate students, respectively, undertaking research at the ITQB during the years 2000 to 2004.

Ph.D. Holders	Laboratory Heads	Post Doctoral Fellows	Other Ph.D. Holders	Total
2000	35	36	46	117
2001	33	39	47	119
2002	34	37	54	125
2003	34	49	35	118
2004	48	55	30	133

Students	Ph.D. Students	Other Graduates	Total Graduates	Under-graduates	Total
2000	96	83	179	37	216
2001	117	90	207	36	243
2002	125	70	195	24	219
2003	118	81	199	24	223
2004	126	98	224	47	271

In the lower table, the category “other graduates” refers to researchers working on short term contracts within research projects and who frequently progress to become full-time Ph.D students.

The Fundação para a Ciência e a Tecnologia (FCT) has been the main source of Ph.D. and Post-doctoral Fellowships, although the contribution from the EC, namely through the Marie Curie Programme, is slowly growing.

Grants from the FCT (2000-2004)

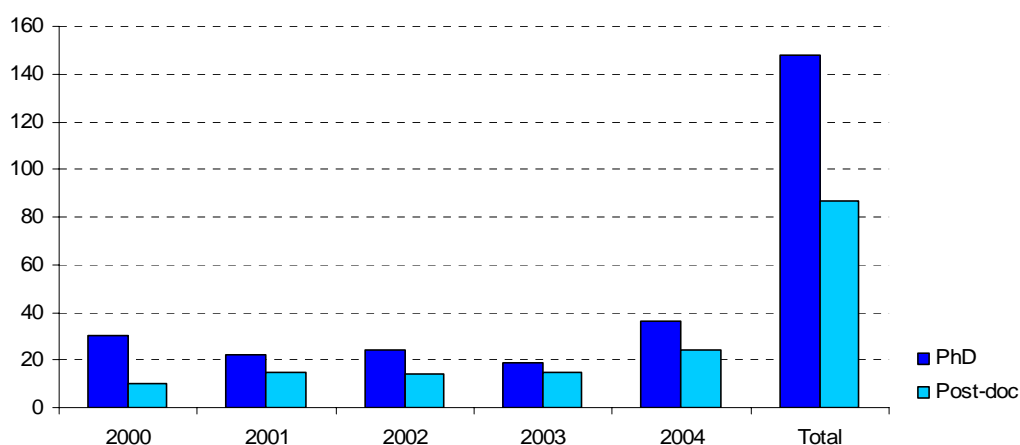

Ph.D. holders and Graduate Students are distributed amongst the ITQB Research Divisions as shown in the following pie-charts.

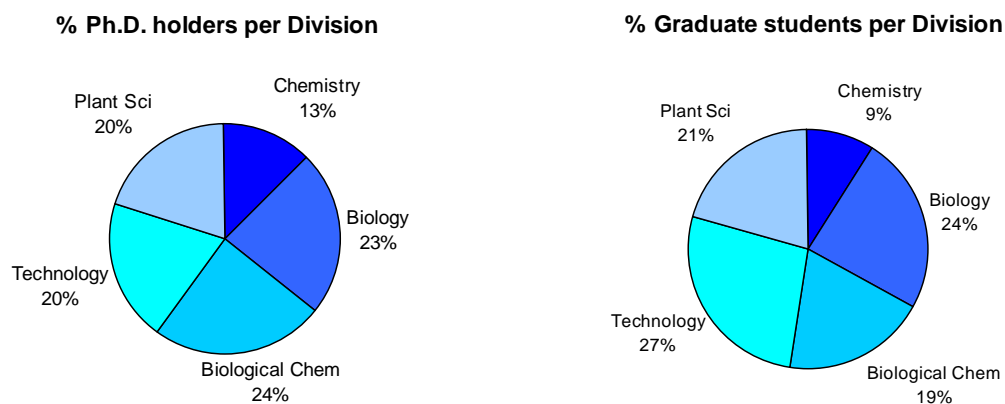

In 2004 the average number of trainees per Ph.D. holder was 2

The graph below shows that 83 Ph.D. thesis have been successfully submitted and examined at ITQB between 1995 and 2004.

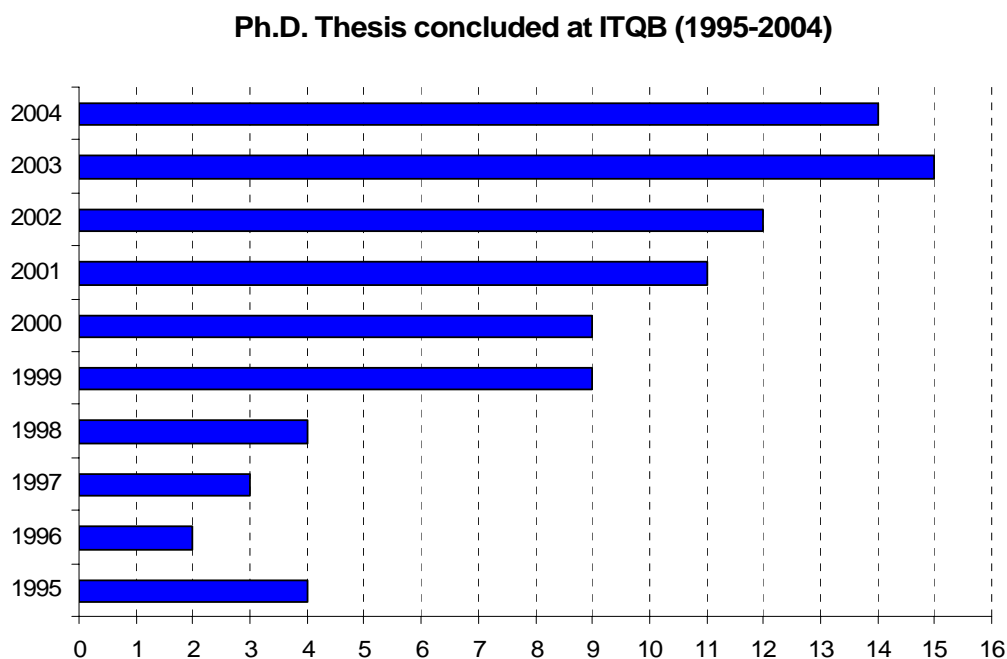

ITQB awards Ph.D. degrees through the Universidade Nova de Lisboa in the scientific areas of Chemistry, Biochemistry, Biology and Chemical Engineering. The figure shows the distribution of degrees amongst these four areas for the period 1995-2004.

Ph.D. Thesis per area (1995-2004)

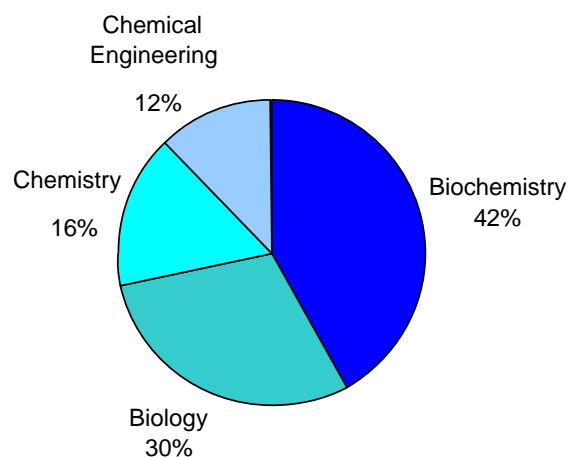

PUBLICATIONS

The complete list of publications by ITQB researchers during 2004-2005 is given in the “Research Output” section. The number of papers published in refereed journals was 128, for 2004 alone. Some 70 papers have been either published or are in press in 2005.

Overall contribution to total number of ITQB papers (2000-2004)

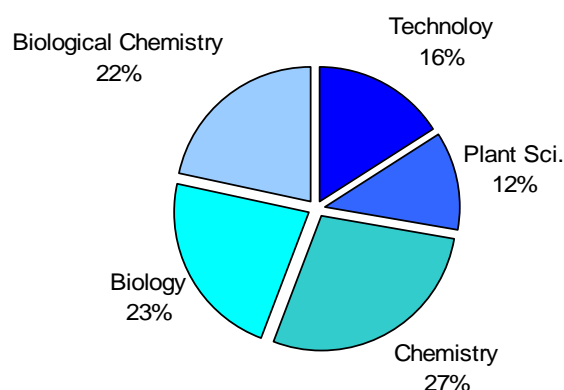

An ad-hoc division of papers among the 5 ITQB research areas yields the following results, although the exact figures have to be treated with caution since many publications span more than one area (papers were attributed to a specific area according to the principal authors):

Papers in refereed journals (2000-2004)

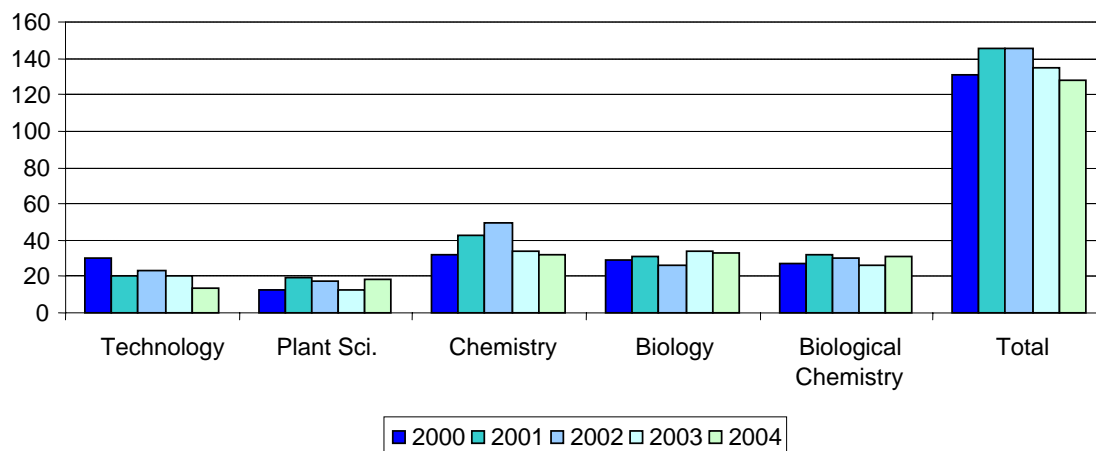

RESEARCH PROJECTS

The main sources of project funding have been the FCT and the European Commission. All projects involving collaboration of ITQB researchers with Industry are organized through IBET, and they are therefore accounted separately. FCT calls for projects were issued in 1996, 1998, 2000, 2001, 2002 and 2004. The number of projects (total submitted and approved) with ITQB as co-ordinating institution is given in the next Figure. Some 22 of the 80 projects submitted by ITQB in 2004 are still waiting for evaluation.

Rate of Approval of FC&T Projects

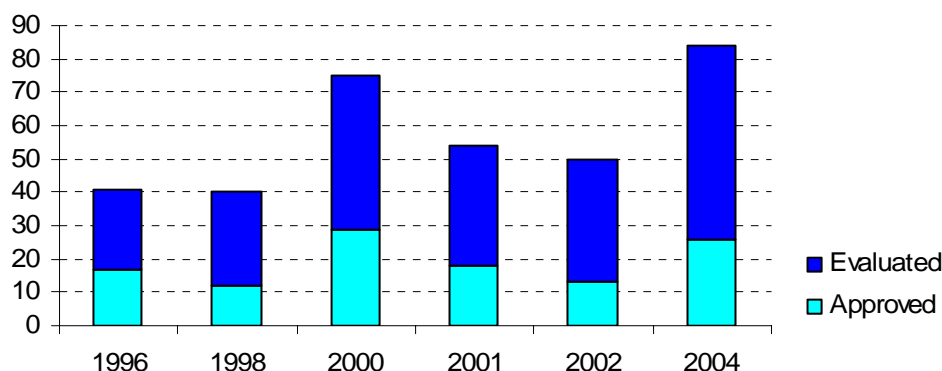

The capability of ITQB to submit competitive projects every year is a necessary condition for the success of the Institute.

BUDGET

The ITQB budget has two main sources of revenue; Universidade Nova de Lisboa, and FCT (Laboratório Associado contract and project funding). European Commission (EC) project contracts also make an important contribution, although on a smaller scale. The different contributions to the budget are plotted as percentages of an overall budget of around 7,6 M€.

However, additional contributions should be considered in order to calculate the overall value-for-money of the ITQB operations. Most of the researchers at ITQB are paid by external sources, either salaries paid by other institutions to senior researchers, or fellowships awarded to graduate students and Post-Docs. The contribution of IBET, in particular, to projects led by ITQB researchers, is also a sizeable amount and represents the part of ITQB activities dedicated to collaboration with industry, and mostly paid by private sources. Taking these considerations into account, a ball park calculation for the overall budget of the ITQB operations would be some 12-13 M€. In this figure, external salaries are calculated as a fraction (from 0.3 to 0.7) of the salaries of senior researchers who perform research at ITQB, but have teaching or other duties in other institutions and are paid by them. Fellowships imply Ph.D. and Post-doctoral fellowships granted by FCT and paid directly to fellows. Equipment depreciation has been included and calculated on the basis of a 20 year lifetime and an initial investment of 20 M€.

An important conclusion is that around **45 % of the total budget** is obtained competitively, usually in response to open calls, evaluated by international panels. The importance of the contribution of project funding to the budget of the ITQB must be emphasized.

However, the present budget is inadequate (see the Director's introduction) and the Orçamento de Estado contribution must be significantly increased if the ITQB is to remain competitive at a national and European level.

ITQB funding

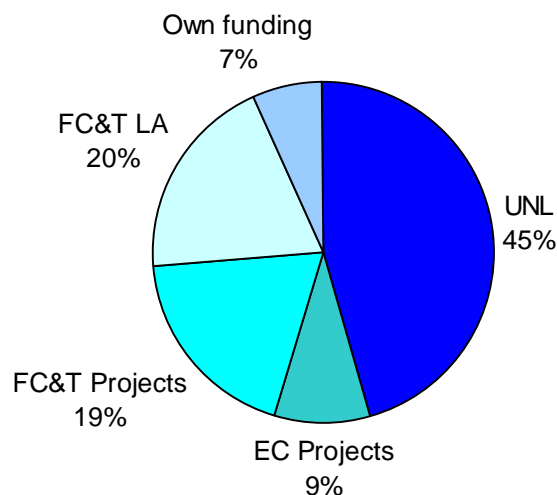

PRIZES AND AWARDS

Prize “Estímulo à Excelência” Awarded to Eight Researchers of ITQB and IBET

In 2004, *Fundação para a Ciência e Tecnologia* awarded the Portuguese scientists that have published 100 scientific articles with more than 500 citations on the Science Citation Index, or scientists that have published 50 articles, with 250 citations and responsible for the formation of at least 10 PhD students.

A total of 73 Portuguese scientists fulfilled the conditions and eight awards were attributed to professors of the five Divisions of ITQB for the work that they developed in different areas of research.



António Xavier
Structure and Function of Metalloproteins



Cândido P. Ricardo
Plant Biochemistry



Carlos Romão
Organometallic Chemistry



Claudina Pousada
Genomics and Stress



Helena Santos
Cell Physiology and NMR



Manuel Carrondo
Animal Cell Technology



Maria Arménia Carrondo
Protein Crystallography



Miguel Teixeira
Metalloproteins and Bioenergetics

International and National Prizes



Claudina Rodrigues Pousada, Head of the Genomics and Stress Laboratory. Prize of the Pan-American Society of Biochemistry and Molecular Biology for the Plenary Conference at the FEBS Congress in Warsaw, Poland (2004).



Miguel Teixeira, Head of the Metalloproteins and Bioenergetics Laboratory. Prize of the Portuguese Society of Biochemistry for the Plenary Conference at the XV National Congress of Biochemistry (2004).



Luís Gafeira Gonçalves, PhD student of the Cell Physiology and NMR Laboratory. Prize to the Poster ““New phosphorylated compounds accumulating in the extreme hyperthermophile *Pyrolobus fumarii* “ on 5th International Conference at the Extremophiles, Cambridge, EUA (2004).



Gonçalo Real, PhD student of the Microbial Development Laboratory. Prize to the Poster “ Requirement for DivIB for asymmetric cell division in *Bacillus subtilis* “ at the European Spores Conference, Smolenice Castle, Eslovakia (2004).



Marta Vasconcelos, Plant Genetic Engineering Laboratory, Prize to the Paper “Enhanced iron and zinc accumulation and absorption in transgenic rice” *Plant Science* (2003)164(3):371-378 at the Annual General Meeting of CGIAR, México (2004).

EUROBIC 2004 PRIZE

Maria Arménia A. F. C. T. Carrondo

Professor Maria Arménia Carrondo received a Diploma in Chemical Engineering in 1971 from the University of Porto, Portugal followed by a Ph.D. Degree from Imperial College of Science and Technology, University of London, England, in 1978. After serving as a research assistant at the University of Porto from 1972-3 she joined the Instituto Superior Técnico, Lisbon, in 1973 and became an Associate Professor in 1980 before receiving an "Agregação" in Chemistry in 1989. In 1998 she became a Full Professor at the Instituto de Tecnologia Química e Biológica in Oeiras and has been a Vice Director of the Institute since 1999.



She was the Founder and Head of the Crystallography Group at the Centro de Química Estrutural, Instituto Superior Técnico, between 1973 and 1989 undertaking structural determinations of organometallic and coordination complexes. She founded the Protein Crystallography Group at the Instituto de Tecnologia Química e Biológica in 1989 and has since directed it to becoming one of the leading research groups in this field in Europe. Her current principal research interests encompass methods and techniques of the determination of macromolecular structure including the use of synchrotron X-radiation and *ab initio* methods of phase determination. On the structural side she has specific interests in the study of electron transfer proteins and metalloproteins and has recently published papers on Bacterioferritins and the CotA multi-copper oxidase from the endospore coat of *Bacillus subtilis*. Several recent projects have involved proteins with pharmacological and biomedical applications in conjunction with industry and, recently, these have extended to a study of membrane proteins. She is an Associate Sub-contractor in the EU "Structural Proteomics in Europe", SPINE, project started in October 2002, and involving some of the most prestigious macromolecular crystallography groups in Europe. She is also a Member of the EU Infrastructure Cooperation Network, MAX-INF, contract nr. HPRN-CT-2000-40021.

Maria Arménia Carrondo has been a member of EMBO since 2000 and an Editor of the Journal of Biological Inorganic Chemistry since December 2001. She was elected an Officer of the Executive Committee of the International Union of Crystallography in 1999 and has been a Chairperson of the IUCr Sub-Commission on the Union calendar since 2002. She was also an Officer of the Executive Committee of the European Crystallography Association (ECA) between 1997 and 2000. She has been the Vice-President of the Portuguese Biochemical Society since 1998. Maria Arménia Carrondo has organized several prestigious international scientific meetings in Portugal including the 17th European Crystallographic Meeting held in Lisbon in 1997 and the FEBS meeting in 2001. She has also represented her country regarding the ESRF Council from 1998-2002. Her contribution to the development of science and technology in Portugal has been significant and her research involving the determination of macromolecular structures of biological importance using X-ray techniques has enhanced the reputation of the ITQB at Oeiras as a center of excellence in Portugal.

Doctor *Honoris causa* : Universidade Nova de Lisboa

Professor Doctor Joachim Klein



The Universidade Nova de Lisboa conferred the Degree of Doctor, *Honoris causa* on Professor Joachim Klein on the 18th February 2005 in the Reitoria. Professor Klein was presented to the University by Professor Manuel Carrondo on behalf of IBET, ITQB and the FCT-UNL. The picture shows the award of the UNL medallion by the Reitor, Professor Leopoldo Guimarães to Professor Klein; Professor Carrondo and the Orator, Professor Virgílio Rosário (IHMT), keep a watchful eye on the proceedings.

Joachim Klein was born in Berlin in 1935 and graduated in Chemistry at the University of Braunschweig in 1961. He obtained his PhD Degree in Technological Chemistry at the University of Munich in 1965, followed by the Agregação from this same University in 1968 and this then initiated his academic career. He was a Visiting Professor in the Chemical Engineering Department at Carnegie Mellon University in Pittsburgh in 1969 and at Waterloo University in Ontario in 1970. In 1971 and 1972 he was a researcher at the Hoechst Company in Frankfurt. He then became Professor and Director of the Technological Chemistry Institute at the University of Braunschweig and remained in this position until 1984. While keeping his position as Professor at this University, Joachim Klein became Scientific Director of two large National Laboratories;

Gesellschaft für Biotechnologische Forschung (GBF) in Braunschweig (1984-1990),
Forschungszentrum für Umwelt und Gesundheit (GSF) in Munique (1990-1995).

He returned to the University of Braunschweig in 1995 and became responsible for the discipline of Macromolecular Chemistry. In 2000 he became the President of the Science Academy in Braunschweig. He was Consultant, Director and President of various other Institutions, Academies and University-Industry Interfaces, as well as a member of the Consultative Board of Universities in Germany and abroad (Technion in Israel, Tianjin in China, Vienna in Austria and IBET/ITQB in Portugal). He has more than 160 publications in peer reviewed international journals to his name, some 30 chapters in scientific and technical books and has been the inventor or co-inventor in 25 patents. He has also supervised 75 researchers who have obtained the PhD degree.

For some 20 years Joachim Klein has been a strong, effective and influential supporter of the ITQB and IBET and it is hoped that this will continue for the foreseeable future.

ITQB goes Public

For many years, ITQB has been working steadily to bring Science closer to the public, although most actions have targeted students and schools. In the past year, ITQB has engaged in several initiatives to raise public awareness of Science and Technology, while at the same time, promoting the Institute and its research in the region of Oeiras. In this context two events have been organized over the past year, a Painting Competition for Children and a Laboratory Open Day. This type of activities was only possible with the active collaboration of researchers and students and the assistance of the technical staff.

Painting Contest and the Open Day were organized by Margarida Archer, Paula Alves, António Lopes, Ana Rute Neves, and Ana Sánchez. Graphical credits are given to Luis Morgado.



Painting Competition (if I were a scientist...)

In May 2004, ITQB organized a painting competition for children between 6 and 12 years old, an initiative that was held in association with the Oeiras City Council (CMO) and integrated with the 10th anniversary of the International Year of the Family. The purpose of this contest was for children to make a painting and finish the sentence "Se eu fosse cientista..." (If I were a scientist...)

**I would do over a hundred experiments
(Hugo, 7 years old)**



The competition was broadly advertised in the region of Oeiras, namely in schools, local county houses, libraries and CMO public offices. The response to this initiative was far above initial expectations and more than 250 drawings were received at ITQB. The general impression of these drawings was that Science is already present in children's minds and is definitely a topic of interest and attraction.

**I would turn my sister into a frog
(Francisco, 7 years old)**

The best drawings were selected by a jury and exhibited at Oeiras Municipal Garden during the "Festas do Concelho" in June. For this occasion, ITQB also organized a short session of scientific experiments specially designed for children.

As a prize for their art and ideas about science 15 children were invited to spend one afternoon in a laboratory at ITQB to see how real science is conducted. Equipped as real scientists with laboratory coats and gloves, these children were able to do some experiments on their own, such as extracting DNA from kiwifruits and separating the colorants from sweets. They could also see the bacteria from yogurts and the yeasts used to make bread under the microscope and learned how chemistry is present even in a chocolate cake.

The visit of the children to ITQB was monitored by reporters from a national weekly magazine (Visão) and a national TV station (SIC).



**I would wear black trousers and a white coat with blue stripes
and would do three potions a day
(Pedro, 8 years old)**

The ITQB Open Day



The ITQB Open Day took place on January 29th 2005. This initiative had the support of Oeiras City Council (CMO) and was sponsored by several companies. The event was broadly advertised in the region, mainly by poster placement and brochures distribution in local schools and other locations (railway station, malls, etc.). The Open Day was included in the local agenda (Oeiras, 30 dias) and was further publicized in newspapers (jornais Destak e Público, revista Visão). Additional promotion was achieved by resorting to e-mailing to various entities (faculties, research institutions, Ciência Viva) and by the open day webpage. In response, almost nine hundred people visited ITQB on that Saturday.

"It is unbelievable that political authorities won't cherish your work. May you have the determination to go on. Congratulations."

The ITQB Open Day was organized very much like a science fair and visitors were allowed to walk around the different activities concentrated at the entrance floor of the Institute. Each Research Division within ITQB was attributed a stand where examples of their research were shown in a very clear and interactive way. Visitors could, for example, discover that bacteria adapt to different habitats, understand why antibiotic resistance occurs, see what proteins look like, learn that plants can live in bottles, find out how chemical reactions can be fun, and realize that Science is already present in many products that we use routinely in our daily lives. Children were given an ITQB passport that they could stamp at every stand they visited and there were many "scientific souvenirs" to take home.

"Congratulations for the initiative, organization and friendliness. I didn't feel time going by. It's wonderful feeling science so closely"

Additionally, there were two areas especially dedicated to the younger visitors. In the Experiment Corner, children could make their own experiments such as extracting DNA from banana or using red cabbage as a pH indicator, while in the Dark Zone, luminescent bacteria and fluorescent compounds could be seen. A short movie covering several aspects of ITQB research activities was displayed in the ITQB Auditorium. The two lectures presented by ITQB





researchers on Chemistry & Cooking and Genetically Modified Plants were also very much appreciated.

The purpose of this event was to attract families from the region of Oeiras and introduce them to the Science conducted at ITQB as well as promoting the dialogue between scientists and the general public. This objective was largely achieved not only by the number of visitors, which surpassed all expectations, but also because the enthusiasm of both researchers and visitors was visible. In fact, the comments written in the guest book were extremely positive and there were several requests for ITQB to organize similar events in the future.

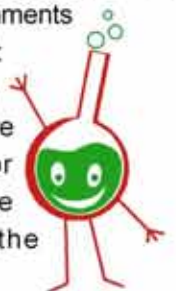

LAB. ASSOCIADO

LABORATÓRIO ASSOCIADO

The Laboratório Associado is a partnership between;

- **Instituto de Tecnologia Química e Biológica (ITQB),**
- **Instituto de Biologia Experimental e Tecnológica (IBET),**
- **Instituto Gulbenkian de Ciência (IGC)**

The contract between the Fundação para a Ciência e a Tecnologia and the Instituto de Tecnologia Química e Biológica initiating the Laboratório Associado was signed in November 2000 and the first scientific staff were appointed in July 2001. The Laboratório Associado is therefore in the final year of its initial five-year contract and is anticipating the negotiation of a second five-year period.

Together the three institutions comprise some 500 researchers of which 200 are holders of the PhD Degree. The Laboratório Associado has the following characteristics;

- An open structure with the participation of researchers of various national and foreign institutions,
- A scientific programme based on the strong interaction of small groups of researchers in different scientific areas,
- A large network of services of high technology, some of which provide national facilities.
- A set of complementary skills that cover a wide area of the Life Sciences and related disciplines. The areas of competence include the structural and functional characterisation, design and production of biologically active molecules, micro-organism physiology and genetics, analysis and manipulation of complex biological systems, and bioinformatics.
- Strong graduate programmes, some of which are also “open” (e.g. PGDB), attracting PhD students from both Portugal and abroad, whilst “placing” them for Thesis work in Laboratories all over the world.

The Laboratório Associado and its research workers are able to benefit from this multi-disciplinary environment in pursuing the research objectives described below. Together, ITQB, IBET and IGC, constitute what is probably a unique combination of Institutes in Europe with the ability and scope not only to undertake high quality research in the Life Sciences and related themes, but in addition to assist with the transfer of this research, where appropriate, to an industrial and economic environment.

In essence, the mission of the Laboratório Associado is to perform the highest quality fundamental research that available resources permit within the Life Sciences and related areas. Another important function is to transfer the science and technology to an industrial and economic base by pursuing applications of the research to improve the quality of life and/or the environment wherever appropriate and feasible. In pursuing these mission objectives the Laboratório Associado serves as a Centre of Excellence for the Life Sciences, both in Portugal and abroad. It provides advanced training for research workers at the pre- and post-doctoral levels, acts as an impartial consultant in areas of public interest such as the genetic manipulation of organisms, and provides a database of scientific knowledge and technological expertise within the Life Sciences.

The Laboratório Associado concentrates its efforts within five thematic lines;

- 1. Biologically Active Molecules**
- 2. Molecular Medicine and Veterinary Studies**
- 3. Developmental Biology in Animals and Plants**
- 4. Biological Risk**
- 5. Improvement of Plants and Forest**

A fundamental objective throughout the research is the understanding of organisms and their interactions with the environment, at the higher levels of organisation. This involves a Systems Biology approach, focused on the organisms and closer to physiopathology, development and evolution, but encompassing the wider systems of biological ecology and spreading to the means of production.

The predictable consequences of the understanding of the behaviour of biologically complex systems and their mechanisms are enormous and of great importance. Reaching this understanding requires the use of new techniques, some of which are still in the developmental stage. These “new” competences need to be used in an interdisciplinary manner, and will open the possibility of participation of new partners (new institutions of R&D, new enterprises, different countries).

The scientific competences of the main institution and its partners in the Laboratório Associado are precisely the hard nucleus (Genome-Proteome, Systems Biology) of these developments. They will allow the exploitation of this knowledge with an impact on the areas of Molecular Design with Pharmaceutical or Agrochemical applications, of Agroforestry Biotechnology, of Food Quality including Genetically Modified Organisms, of Genetic Resistance to Drugs and also Infections and Developing Diseases inserted in a modern Clinical Epidemiology, and of Development Biology and Molecular Medicine.

APPOINTMENT OF STAFF

The tables below indicate the appointment of staff specifically prescribed in the contract and additional to those in the three Institutions.

Table 1. Appointment by year.

Year	1	2	3	4	5
Researchers	8	5	4	4	4
Technicians	7	2			

Table.2 Appointment by scientific theme. Figures in parenthesis indicate current appointments.

Theme	1	2	3	4	5
Researchers	8(5)	6(4)	3(2)	4(4)	4(3)
Technicians	2(2)	2(2)	1(1)	3(3)	1(1)

(i) Scientific Staff.

The following list indicates the staff appointed. In classifying the area of research, it should be remembered that many of the scientists undertake studies that traverse the boundaries between one or more themes.

1. Biologically Active Molecules.

Ricardo Louro	(16 th October 2001)	ITQB
Daniel Murgida*	(29 th October 2001)	ITQB
António Baptista	(1 st May 2003)	ITQB
Margarida Archer	(1 st July 2003)	ITQB
Cláudio Gomes	(1 st December 2003)	ITQB
Beatriz Royo	(1 st December 2003)	ITQB

2. Medicine and Veterinary Studies.

Miguel Soares	(1 st July 2001)	IGC
Paula Alves	(11 th September 2001)	IBET
Carlos Gonçalves	(1 st August 2003)	IGC
Sergio Filipe	(1 st October 2004)	ITQB

3. Developmental Biology in Animals and Plants.

Moises Mallo Perez	(1 st July 2001)	IGC
Jorge Carneiro	(26 th June 2002)	IGC

4. Biological Risk.

Ana Martins**	(1st September 2001)	ITQB
Rosário Mato	(17 th December 2001)	ITQB
Maria de Fátima Lopes	(16 th June 2002)	IBET
Ana Rute Neves	(1 st December 2003)	ITQB
Ana Simplicio	(1 ST May 2004)	IBET

5. Improvement of Plants and Forests.

Margarida Rocheta	(2 nd October 2001)	IBET
Philip Jackson	(16 th July 2002)	ITQB
Rita Abranches	(1 st December 2003)	ITQB

* Daniel Murgida left to take up a position at the Technical University in Berlin, early in 2002.

** Ana Martins resigned from the Laboratório Associado on the 31st August 2003.

According to the Laboratório Associado contract there are 7 vacancies, 3 in 2004 and 4 in 2005, distributed 4 to ITQB, 1 to IBET and 2 to IGC. The vacancies for 2004 were frozen by the FCT, but an appointment procedure is in progress.

(ii) Technical Staff.

Nine technicians have also been recruited as specified in the Laboratório Associado Contract.

Name	Start	Finish	Institute	Responsible
Sandra Diniz da Silva	09Oct01	08Oct06	IBET	M. Carrondo
Cátia Maria Morgado Peres	16Oct01	15Oct06	IBET	M. Carrondo
Marta Aires de Sousa Ferreira	17Dec01	16Dec06	ITQB	H. de Lencastre
Ana Cabral Couto Lopes Nóvoa	21Jan02	20Jan07	IGC	A. Coutinho
Paula Isabel Loução Alves	19Mar02	18Mar07	IBET	M. Carrondo
Paulo David Dias Almeida	26Jun02	25Jun07	IGC	A. Coutinho
Sandra Isabel Coimbra Miranda	11Sep02	10Sep07	IBET	M. Carrondo
Sandra Maria Monteiro	01Feb03	21Jan08	IBET	M. Carrondo
Elisabete Andrade Alves Pires	01Jul03	30Jun08	ITQB	A M. Coelho

HIGHLIGHTS

The Highlights for the researchers directly employed on the Laboratório Associado contract have been separated from the Research Divisions of the ITQB to emphasize their effectiveness and contributions to the overall research program. The research teams can be found listed in the various Divisions. The Highlights are presented according to the five themes described above.

Thermodynamic Characterization of Multi-Haem Cytochromes using NMR.

Ricardo O. Louro: Inorganic Biochemistry and NMR Laboratory.

The detailed functional characterization of biological molecules containing multiple active sites requires the use of experimental techniques that allow discrimination of the various centres in the different states that they can assume. High-resolution NMR spectroscopy provides the required discrimination and making use of dynamic techniques a detailed thermodynamic characterization of the target proteins can be achieved. This analysis was applied to multi-haem cytochromes from anaerobic bacteria that participate in the anoxygenic respiratory processes of these organisms. Anaerobic bacteria, in particular the delta-proteobacteria division, are prominent in marine and estuarine environments and have been targeted for bioremediation applications due to their metabolic diversity which allows them to reduce and precipitate soluble metal compounds of environmental interest such as chromium, uranium and manganese. A detailed knowledge of the electron flow in the ramified respiratory chains of these organisms and within specific key proteins and enzymes will allow for better bioremediation strategies to be proposed. The characterization of the flavocytochrome c_3 from *Shewanella frigidimarina* which is the terminal reductase in fumarate respiration, established a quantitative difference with respect to previous studies since it showed that a detailed analysis can be accomplished for proteins with up to 5 redox centres and up to 64kDa molecular weight. It also established a qualitative difference since it was the first time that such detailed analysis was applied to an enzyme. These studies showed that flavocytochrome c_3 has evolved in a way to ensure unhindered flow of electrons through the haem chain leading to the flavin active site, with conveniently ordered redox potentials.

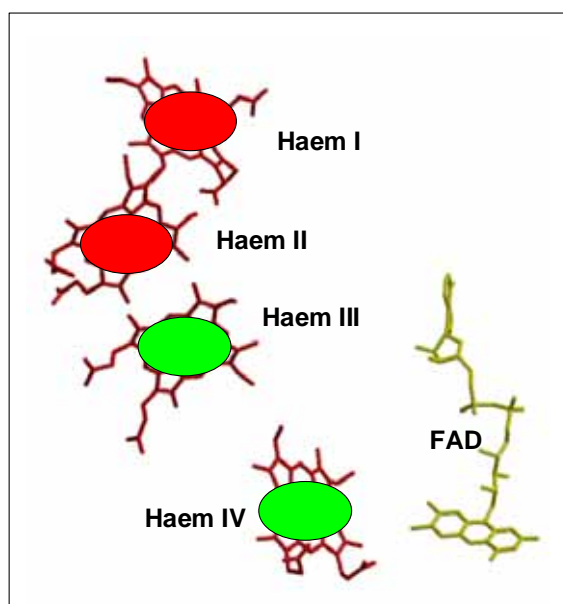

Figure 1. The haems in the structure of flavocytochrome c_3 are overlaid with coloured ellipses that represent the asymmetric distribution of the redox potentials of the haems that favour the flow of electrons into the flavin active site of the enzyme.

Understanding pH-induced Conformational Changes by Molecular Simulation: the Helix-coil Transition of Polylysine as a Model of Conformational Modulation by pH.

António M. Baptista : Molecular Simulation Laboratory.

The area of protein folding has recently received another further impetus from the study of amyloid diseases, where misfolded proteins can lead to extensive aggregation. In many cases the folding/unfolding/misfolding equilibrium is found to be strongly dependent on pH. Until recently, the computational study of pH-induced conformational changes had to be performed using molecular simulation methods not entirely adequate for that purpose; the best one could do was to choose a set of charges assumed to be "typical" for the pH of interest. Unfortunately, "typical" charges are often wrong for a particular protein and are usually strongly coupled with its conformational state. The proper approach would be to allow the charges in the protein to adapt to the conformation during the simulation. This can be achieved with the constant-pH molecular dynamics methods recently introduced by us.

We have performed a molecular simulation study of the helix-coil transition of polylysine (decalysine), using constant-pH molecular dynamics. Polylysine is a traditional example of pH-induced conformational change and can be regarded as a model system for understanding the molecular reasons behind the conformational modulation of peptides and proteins by pH. The study was able to describe quite well the coupling between protonation and conformation. In particular, the experimentally observed discrepancy between the midpoints of the titration and helix-coil transition curves was accurately reproduced. Furthermore, the titration of polylysine was shown to proceed very smoothly, as found experimentally. These results indicate that our methodology can properly capture the pH dependence of conformational changes and can thus be a useful tool for understanding folding/unfolding/misfolding processes associated with pH.

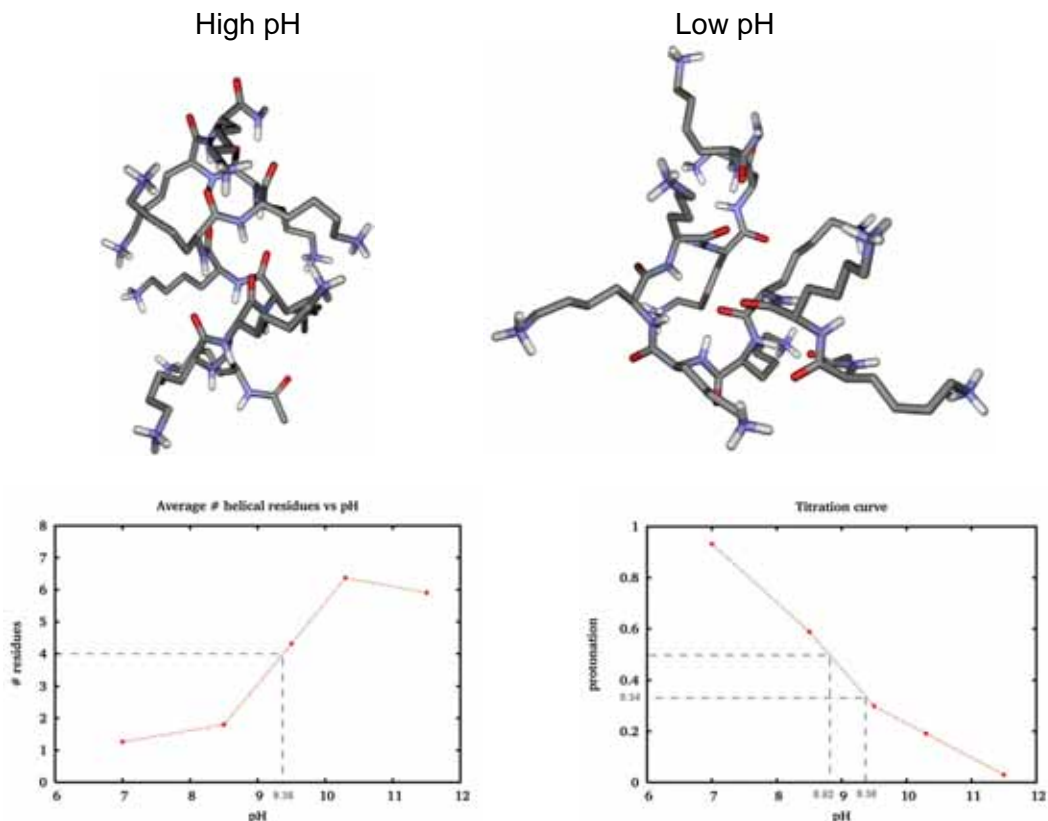

NADH Dehydrogenase – a Membrane Associated Protein.

Margarida Archer: Membrane Protein Laboratory.

The structure of the NADH dehydrogenase (NDH) type II, isolated from the *Acidianus ambivalens* has been solved. This 47 kDa associated membrane enzyme contains a covalently bound flavin as its only redox cofactor. The organism from which NDH is isolated is an hyperthermoacidophilic archaeon, possessing a very simple respiratory chain. The determination of this structure will help to elucidate the electron transfer mechanism within this chain.

X-ray diffraction data was collected using a synchrotron source to ~2.6 Å resolution and model building and crystallographic refinement is at an advanced stage.

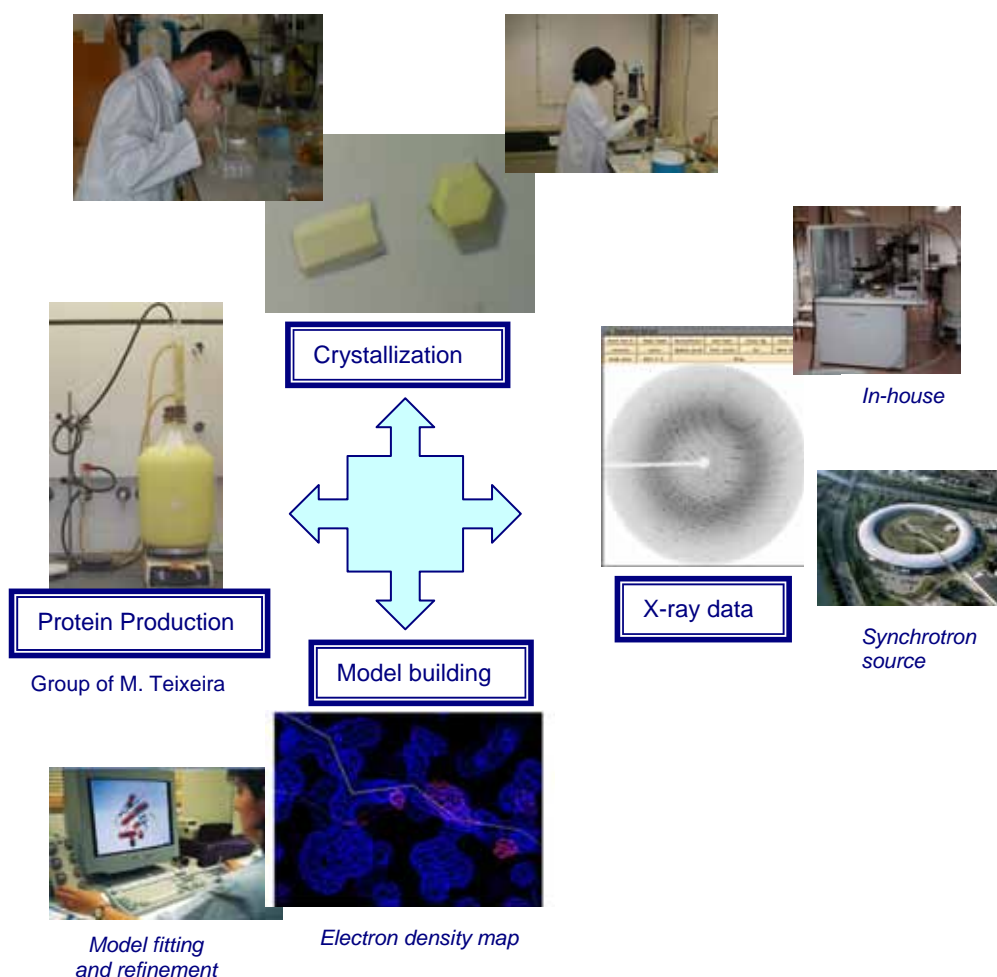

Degradation pathway of iron sulfur proteins.

Cláudio M. Gomes : Protein Biochemistry, Folding and Stability Laboratory.

Metals play an essential role in biological systems and around one third of the proteins present in a cell are metalloproteins, that is, they contain either a metal as a cofactor or a metal containing cluster. The latter are particularly relevant in terms of protein structural stability and folding since they act as local structural stabilising elements in the folded state, contributing to the maintenance of a given specific structural fold, but are also potential key nucleation points during *in vivo* folding as their binding to the unfolded polypeptide is likely to impose a conformational restriction which lowers the entropy of the unfolded state thus favouring a specific folding pathway.

Proteins containing iron-sulfur clusters (see figure for examples) are widespread in the three domains of life, and they play diverse biological roles, from simple electron transfer processes to catalysis and regulation of transcription. Their ubiquity and involvement in anaerobic metabolic pathways suggests that these proteins are very ancient catalysts.

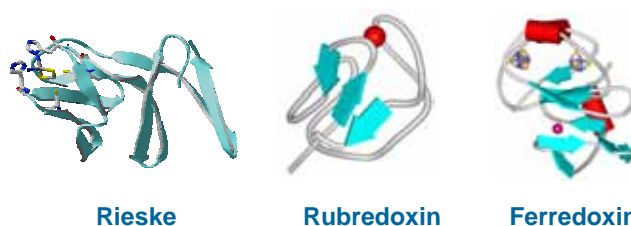

One approach towards the understanding of the role of the clusters in protein stability consists of the characterisation of their disintegration during protein unfolding, which may elicit the involvement of intermediate cluster structures or highlight the role of particular structural elements. In this respect, we have been studying the stability properties of several thermophilic iron sulfur proteins, including ferredoxins [1,2], rubredoxins and a Rieske Ferredoxin [3], using complementary biochemical, spectroscopic and biophysical methodologies.

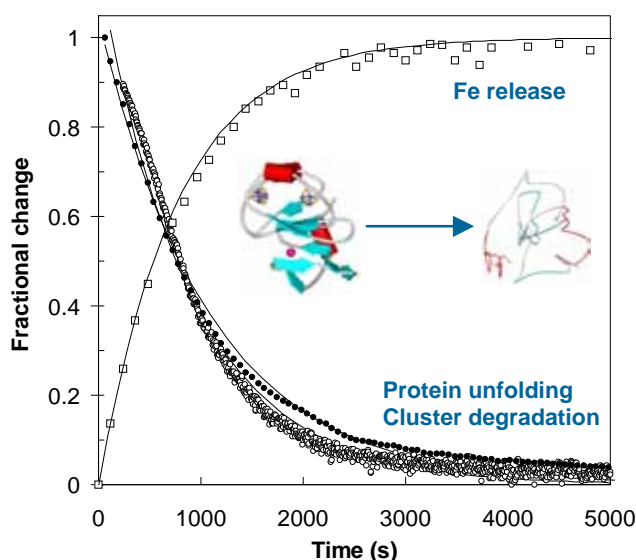

This year we have established [4] that during the chemical alkaline degradation of a dicluster, seven iron ferredoxin, shortly after onset of protein unfolding, iron is released monophasically at a rate which is comparable to that of the degradation of the iron-sulfur centres. The ferredoxin degradation pathway comprises an initial step in which the protein is destabilised to an open conformation, which results in an exposure of the iron-sulfur centres. Our data suggests that both iron-sulfur clusters degrade simultaneously, a feature also evidenced by ¹H-NMR studies. More importantly, during this process there is no detectable formation of any intermediate species involving the metal clusters. Thus, a previous hypothesis suggesting that the decomposition of iron sulfur clusters was proceeding via linear three iron sulfur centres has been reassessed.

References [1] Gomes, C.M. et al. (1998) *J. Biol. Inorg. Chem.*, 3, 499-507; [2] Moczygemba, C. et al. (2001) *Protein Sci.*, 10: 1539-1548.; [3] Kletzin, A. et al. and Gomes, C.M. (2005) *FEBS Lett.* *in press* [4] Leal, S.S., Teixeira, M., Gomes, C.M. (2004) *J. Biol. Inorg. Chem.* 9, 987-996

Molybdenum Oxo Complexes as Catalysts for Hydrosilylation of Aldehydes and Ketones.

Beatriz Royo : Homogeneous Catalysis Laboratory.

The activation of a Si-H bond is one of the key steps in hydrosilylation and other catalytic reactions. Numerous transition metal complexes activate Si-H bonds via oxidative addition to form hydrido silyl species. Recently, Toste and co-workers have proposed an alternative mechanism for the catalytic hydrosilylation of carbonyl groups, in which a metal hydride species is produced by a [2+2]-type addition of the Si-H bond to a metal-oxygen π -bond.¹ In order to further explore the use of metal-oxo complexes as catalysts for the reduction of carbonyl groups, we studied the catalytic activity of the dioxomolybdenum compound $[\text{MoO}_2\text{Cl}_2]$ (**1**) in the hydrosilylation of aldehydes and ketones. We found that **1** is a highly effective catalyst for hydrosilylation of aromatic aldehydes and also ketones with dimethylphenylsilane.² The reaction of 4-nitrobenzaldehyde and dimethylphenylsilane at room temperature in dichloromethane afforded dimethyl-(4-nitrobenzyloxy)-phenyl-silane in essentially quantitative yields after being stirred for 4 h. The reaction is compatible with a wide range of functional groups such as nitro, cyano, halo and esters. As such, this reaction provides an efficient and practical one-step reduction-protection method in which no byproducts are produced.

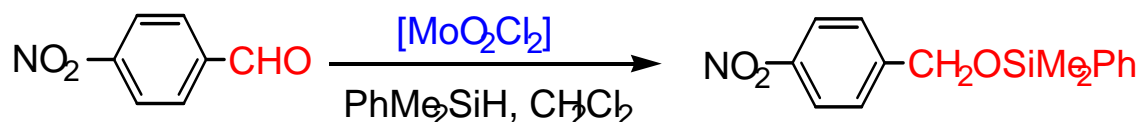

¹ J. J. Kennedy-Smith, K. A. Nolin, H. P. Gunterman, and F. D. Toste, *J. Am. Chem. Soc.*, 2003, *125*, 4056.

² A. C. Fernandes, R. Fernandes, C. C. Romão and B. Royo, *Chem. Commun.*, 2005, 213.

The Molecular and Cellular Mechanisms Controlling Inflammation.

Miguel Soares : Inflammation Laboratory (IGC).

Despite its rather old but accurate definition by Celsus (AD40) as ‘*rubor, calor, dolor, tumor*’ (redness, heat, pain and swelling), inflammation remains an intellectually challenging problem. Inflammation is critical to initiate immune responses that will ultimately lead to the clearance of microbial infections. So far the belief had been that understating how inflammatory reactions are controlled should allow their manipulation to increase the efficiency of microbial clearance. In the

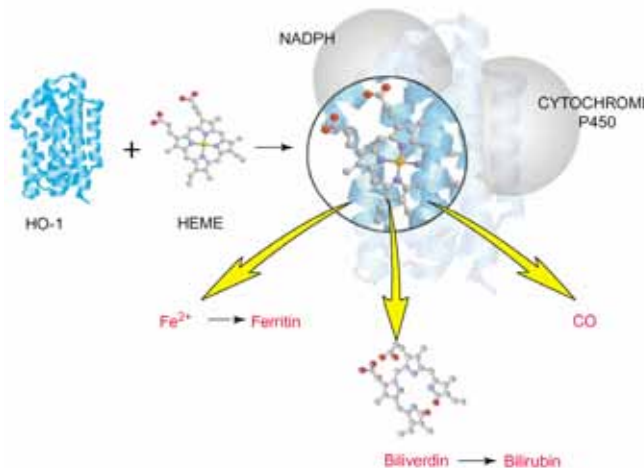

Heme oxygenases (HOs) are ubiquitous enzymes that catalyze the initial and rate-limiting steps in the oxidative degradation of heme to bilirubin. HOs cleave a mesocarbon of the heme molecule, producing equimolar quantities of biliverdin, iron, and carbon monoxide (CO). Biliverdin is reduced to bilirubin by bilirubin reductase, and the free iron released from heme is used in intracellular metabolism to induce the iron chelator ferritin, by which it is sequestered.

inflammatory genes critically involved in the pathogenesis of inflammatory diseases such as atherosclerosis (2). We found that this effect is mediated via inhibition by HO-1 of nuclear factor kappa B (NF- κ B), a transcription factor involved in the expression of these pro-inflammatory genes. Another line of investigation revealed that HO-1 modulates another signal transduction pathway, i.e. the p38 mitogen activated protein kinases, to the same aim. It targets specifically the pro-inflammatory p38 isoform (α) for proteolytic degradation, “imposing” signal transduction to occur through the anti-inflammatory p38 β isoform (*G. Silva et al, submitted for publication*). Presumably these effects of HO-1 exerted in endothelial cells contribute for the observation that this protective gene prevents the pathogenesis of arteriosclerotic lesions (3), including those leading to cardiovascular diseases (*I. Pombo et al. unpublished observation*).

last few years it has become apparent however, that when inflammatory reactions are not well controlled they cause tissue injury and lead to “more harm than good”. This is illustrated by the increasing number of diseases now considered to have ‘inflammatory’ origin, e.g. sepsis, autoimmune diseases or atherosclerosis (1). Our laboratory seeks to decipher the molecular and cellular mechanisms controlling inflammatory reactions and avoid the occurrence of these inflammatory diseases.

We have so far capitalized on our original finding that expression of heme oxygenase-1 (HO-1) (see box) in vascular endothelial cells controls inflammation in such a manner. During the past year we have described that HO-1 expression in endothelial cells inhibits the expression of a subset of pro-

1. C. Nathan, *Nature* **420**, 846 (Dec 19-26, 2002).
2. M. P. Soares *et al.*, *J Immunol* **172**, 3553 (Mar 15, 2004).
3. L. E. Otterbein *et al.*, *Nature Medicine* **9**, 183 (2003).

The Metabolism of Brain Cells.

Paula M. Alves : Animal Cell Biotechnology Laboratory.

Brain is a highly complex system and therefore, simple models are required for understanding the basic biochemical features of individual cell types. We are using primary cultures of rat brain astrocytes in traditional static cultures and in bioreactors to investigate cell metabolism.

Recently we pioneered a technique to study the growth and maintenance of primary astrocytes under fully controlled environmental conditions. For this purpose astrocytes were immobilized in Cytodex microcarriers and grown in a stirred tank bioreactor. The culture system described is a novel tool to study brain cell metabolism, allowing sampling over time and monitoring cellular behavior throughout stressful conditions and during recovery. Figure (A) shows a schematic representation of the small scale bioreactor designed by our team. Figure (B) shows Rat primary astrocytes growing on the surface of Cytodex 3 microcarriers visualized by confocal microscopy and Figure (C) indicates dissolved oxygen and pH profiles obtained in a fully controlled bioreactor.

Sá Santos, S., Fonseca, L.L., Monteiro, M.A.R., Carrondo, M.J.T., Alves P.M. (2005) Culturing primary brain astrocytes under fully controlled environment in a novel bioreactor. *J Neuroscience Research*, **79**: 26-32.

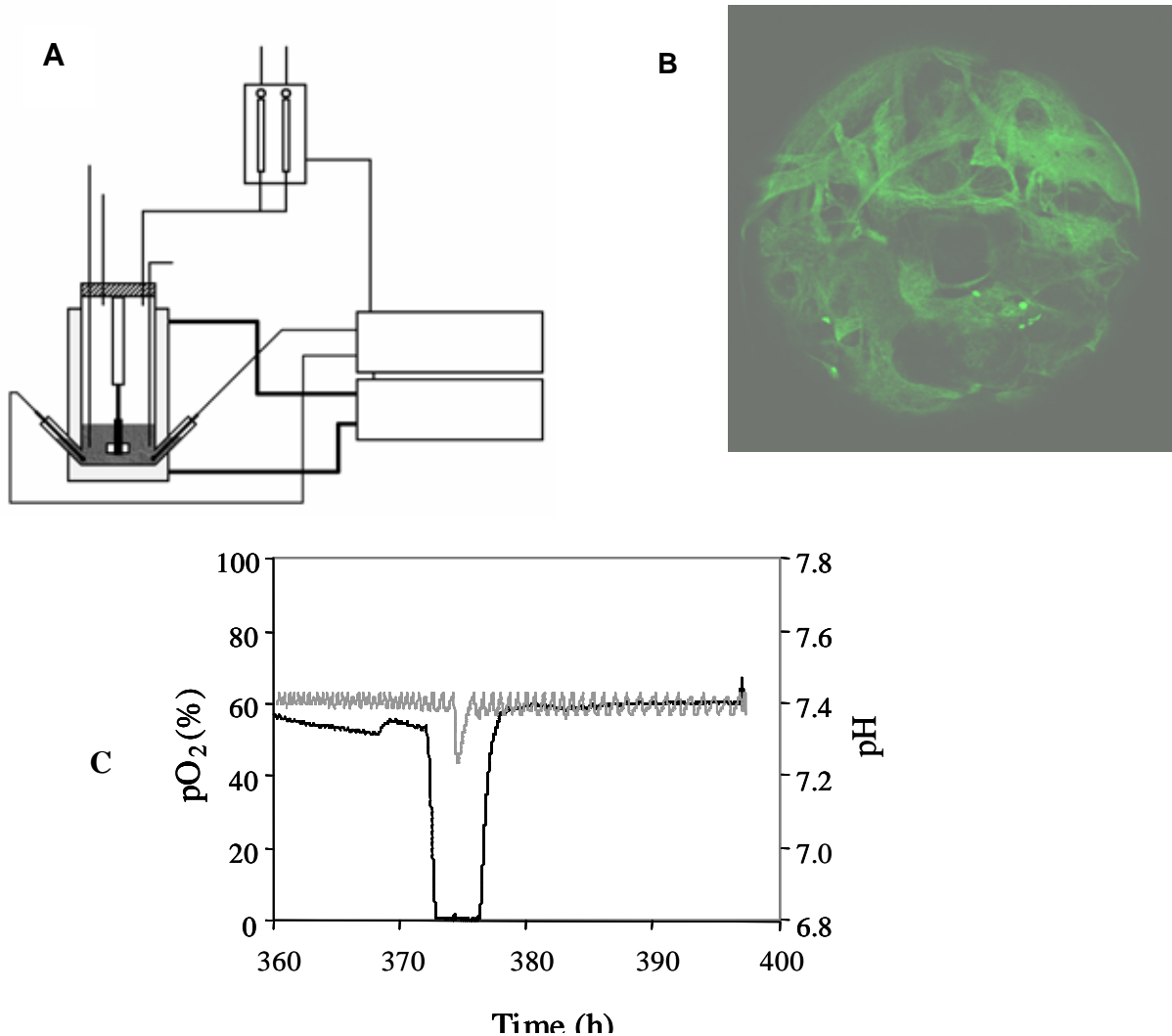

Genetic Factors involved in Disease Resistance or Susceptibility.

Carlos Penha Gonçalves : Disease Genetics Laboratory (IGC).

The research program is based on the systematic analysis of the individual genetic factors involved in disease resistance or disease susceptibility both in humans and in murine models. The vast majority of common diseases studied to date have been shown to depend on multiple genetic factors. This is the case of several autoimmune and infectious diseases where the main challenge is now to reveal the contribution of individual genetic factors to the disease process. The strategy is to combine the knowledge acquired in studying disease genetics in animal models with the expertise on recent tools enabling the genetic study of complex diseases in human populations. The research program is focused on type 1 diabetes and malaria and will be develop in 4 distinct but convergent perspectives;

(1) Mouse Genetics

A sub-phenotype approach to understand the gene biology of individual loci involved in disease resistance and disease susceptibility is being followed.

(2) Human Genetics

The genetic complexity underlying the common diseases and our limited knowledge on the identity of disease genes undermine the feasibility of studying the pathogenesis role of a large number of etiological factors using the same approach. Therefore, targeting individual susceptibility loci and designing specific approaches on a case by case basis is being undertaken. This strategy is being used both in studying pathogenesis components of type1 diabetes and malaria in humans.

(3) Statistical Genetics

Statistical genetics is poorly developed in the country and efforts are focused on starting a statistical genetics nucleus. The aim is to formulate better models for genetic interaction of qualitative and quantitative traits.

(4) Bioinformatics

This mainly relates to the exploitation of genome databases to assist genetic mapping and gene isolation. The activities to be developed include, scanning sequence databases for genetic polymorphism and genome annotation directed to the chromosomal regions of interest.

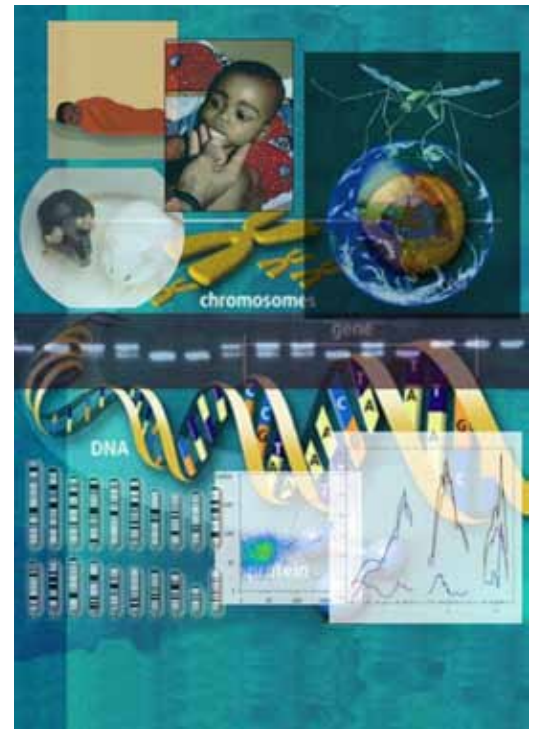

Biological activity of bacterial cell wall and its components.

Sérgio R. Filipe : Microbial Pathogenesis and Cell Biology Laboratory.

The laboratory of Microbial Pathogenesis and Cell Biology was initiated in October 2004. Studies of interest include the elucidation of how pathogenic bacteria such as *Staphylococcus aureus* and *Streptococcus pneumoniae* divide and, in particular, what happens in the process of bacterial cell wall synthesis. The assembly of the bacterial cell wall is carried out by an extremely complex mechanism that allows incorporation of new building blocks without weakening of the cell wall. Perturbation of this process by antibiotics or other stresses may result in a cell wall that it is not strong enough to protect bacteria from the incredible osmotic pressure to which it is subjected. On the other hand there is, in some bacteria, a mechanism of cell wall turnover in order to recycle the building blocks or eventually to control the release of cell wall fragments to the exterior. These cell wall fragments may be recognized by the host immune system and allow triggering of an inflammatory response with the aim of removing the bacterial agent. In collaboration with Dr. Petros Ligoxygakis (University of Oxford) we have determined that muropeptides from *S. aureus* and *S. pneumoniae*, the smallest component of the bacterial cell wall, can induce an innate immune response in *Drosophila* flies. We hope to determine whether this response is conserved in mammals and whether it has a significant effect on the ability of bacteria to infect or colonize their hosts.

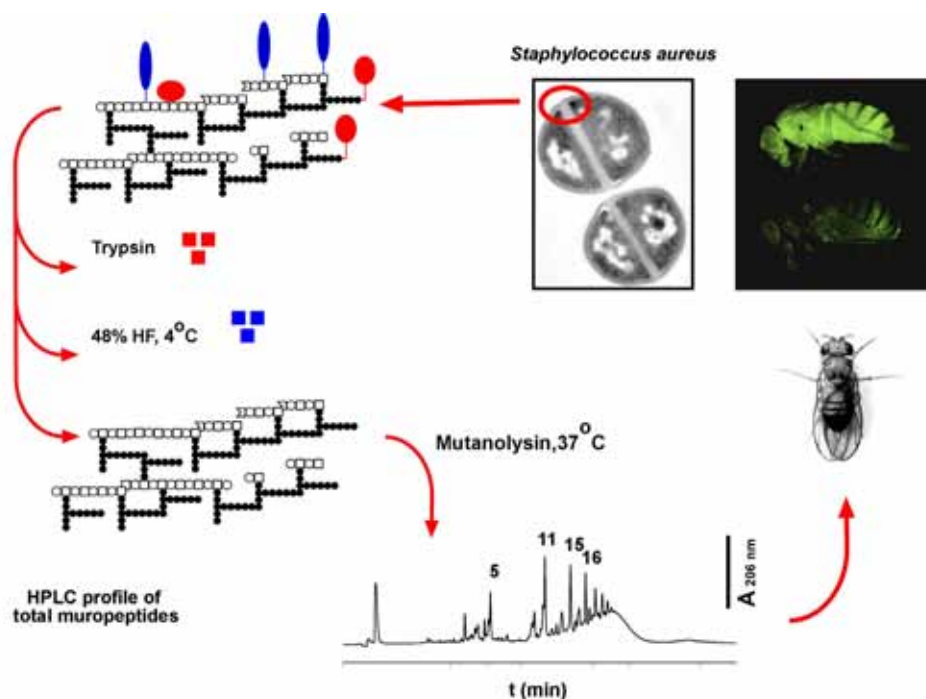

Hox Genes Pattern the Axial Skeleton in the Presomitic Mesoderm.

Moises Mallo : Neural Crest and Gene Modification Laboratory (IGC).

Hox genes are key regulators of vertebral type specification. Vertebrae are the basic units of the axial skeleton. Embryologically, the axial skeleton is derived from the somites, segmental units organized in pairs on both sides of the developing neural tube. Somites are formed in a rostro-caudal sequence by the epithelialization of mesenchymal cells at the rostral end of the presomitic mesoderm. It is generally assumed both in original papers and text books, that the pattern of somitic differentiation (*i.e.* the vertebral type that originates at each axial level) depends on the combination of *Hox* genes they express. However, experimental findings often do not fit within this concept. For instance, the *Hox10* group genes, which are essential for the absence of ribs at the lumbar level, (when all six *Hox10* group alleles are removed from the embryo by homologous recombination, ribs grow in the lumbar vertebrae) are not expressed in the somites that will form lumbar vertebrae. However, they are expressed in the presomitic mesoderm that will form these somites, suggesting that the function of these genes is essential in the presomitic mesoderm and not in the somites.

Hoxa10 were expressed either in the presomitic mesoderm or in the somites corresponding to the future thoracic vertebrae (which have ribs) and the resulting phenotypes compared. We found that *Hoxa10* expression in the presomitic mesoderm produced a complete absence of ribs in the transgenic embryos (see figure), an effect that is not achieved when it is expressed in the somites.



Figure 1. Skeletal staining of a wild type and a transgenic newborn mouse in which *Hoxa10* was expressed in the presomitic mesoderm under the control of the *Dll1* promoter. Note the absence of ribs in the transgenic (asterisk).

This is a major conceptual change in how we face *Hox* activity in development and evolution. It changes the focus of our search for the targets and mechanisms of *Hox* gene activity, and even suggests how their role in somitogenesis involves specific signaling processes (the segmentation clock), which have also been implicated in segment identity.

A handle on the functional repertoire of regulatory T lymphocytes.

Jorge Carneiro : Theoretical Immunology Laboratory (IGC).

Hitherto the fundamental mechanism by which the immune system is able to fight infections while being tolerant to body components is unclear. The cellular basis of this mechanism involves regulatory CD4+ T cells, which prevent autoimmunity in healthy individuals, and in some instances control immune responses to infectious agents. However, assessing the importance of these cells requires answering the question, "how diverse should the pool of regulatory T cells be in order to allow for efficient self-nonself discrimination?". Current immunological theory provides no answer to this question creating difficulties in raising new testable predictions. Some of these difficulties might be overcome by the recent developments of our quantitative model describing the cell population dynamics of regulatory T cells (Carneiro et al. *J. Comp. Appl. Math* 2005 in press). Our model predicts how the number of APCs that stimulate a specific T cell clone determine its relative clonal size and its composition in terms of regulatory and effector cells (fig. 1). We have shown that under specific conditions, the system dynamics is such that the CD4 T cell repertoire naturally breaks into two sets of clones; a larger, more diverse set of small clones containing only effector T cells that are only poorly stimulated by self-antigens and are free to mount immune responses, and a less diverse set also of small clones, strongly stimulated by self-antigens, and containing both effector and regulatory T cells that prevent autoimmunity. According to the model, the relative proportion of these two clone subsets controls the efficacy in self-nonself discrimination, and abnormal biases can lead to either autoimmune pathologies or immunodeficiencies.

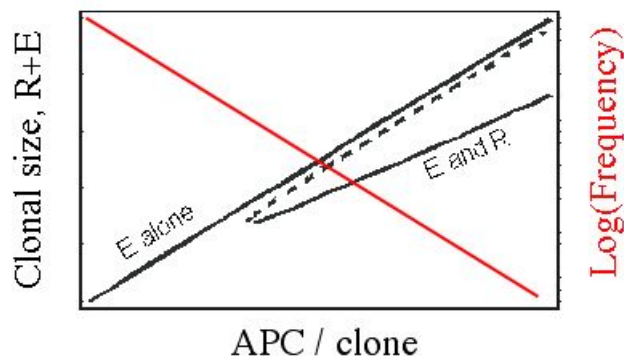

Figure 1- Relative clonal size versus APC/ clone according to a model of regulatory and effector T cell dynamics. Continuous and dashed black lines represent stable and unstable steady states predicted by the model. The red line indicates the frequency of the clones with a given size. Adapted from: Carneiro et al. *J. Comp. Appl. Math.* 2005 in press.

The Role of *Enterococcus Faecium* and *Enterococcus Faecalis* in Hospital-Acquired Infections.

Rosario Mato : Microbial Epidemiology Laboratory.

Enterococci, namely the species *Enterococcus faecium* and *E. faecalis*, are the second or third most important bacterial genus in hospital-acquired infections causing a range of infections related with high mortality, particularly in high-risk groups such as neonates at the intensive care units, and haematological malignancy patients. These microorganisms have two important characteristics; their resistance to most currently approved antimicrobial agents including glycopeptides, and their enormous capacity to transfer antibiotic resistance genes to other bacteria, namely the *vanA* operon to the more virulent methicillin-resistant *Staphylococcus aureus*. These important features make the evaluation of the prevalence of nosocomial infection and colonization by multiple-antibiotic resistant *Enterococcus* strains in critical patients, the implementation of infection control measures, and epidemiological surveillance studies at the hospital setting, absolutely crucial. The Laboratory of Microbial Epidemiology focuses its research on;

- The evaluation of the prevalence of nosocomial infection and/or colonization by clinical relevant enterococcal species.
- The application of typing methodologies on the characterization and identification of the clonal types circulating at the hospital setting.
- The detection of virulence genetic determinants associated with glycopeptide-resistant enterococcal strains (GRE).
- Surveillance studies of multi-drug resistant enterococci isolated from infection and carriage in high-risk patients, as well as the identification of the risk factors that contribute to the infection and colonization by GRE.

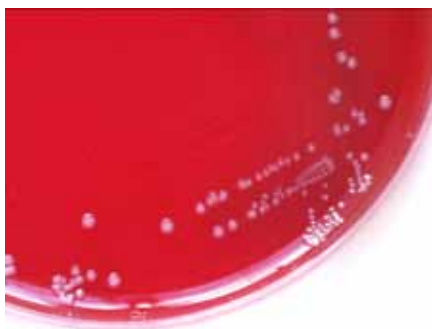

Enterococcus faecalis

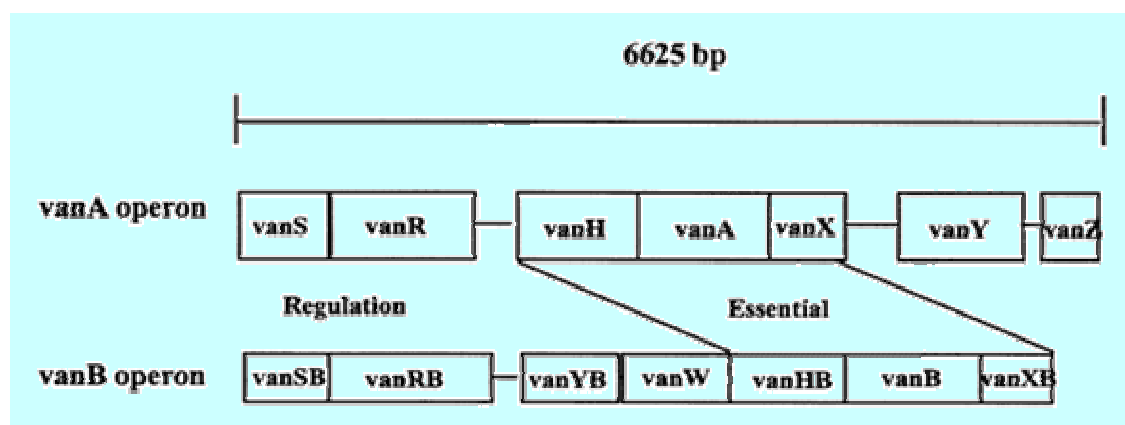

Van A and Van B glycopeptide resistance operons.

Identification and Characterization of a Unique Bacterial α -Phosphoglucumutase in *Lactococcus lactis*.

Ana Rute Neves : Lactic Acid Bacteria and *in vivo* NMR Laboratory.

α -Phosphoglucumutases (α -PGM) which catalyze the specific conversion of α -glucose 1-P into glucose 6-P are widespread among living organisms. In bacteria, this reaction is involved in the production of cell wall, polysaccharide synthesis and galactose metabolism.

In our group, the identification of α -PGM as a metabolic bottleneck during galactose metabolism in *Lactococcus lactis* was of major importance in designing a metabolic engineering strategy aimed at improving galactose consumption. *L. lactis* contains α -PGM activity but, over-expression of *femD*, the only homologue in the sequenced genome of this organism with significant identity to α -D-phosphohexomutases (~550 amino acids in length), did not result in the expected enhanced α -PGM activity. Therefore, we deemed it important to identify the gene encoding the α -PGM activity. The α -PGM was purified from cell extracts and its N-terminal protein sequence determined. A gene coding for the isolated protein was identified by homology search. Cloning and overexpression of that gene led to a 30-fold increase of α -PGM activity. The protein shows a certain degree of homology to eukaryotic phosphomannomutases (260 amino acids in length), and likewise is 252 amino acids in length. Full biochemical characterization of the enzyme was performed and the effect of its overproduction on glucose and galactose metabolism was investigated. Galactose consumption is improved in cells where α -PGM activity is increased. A manuscript describing the results is in preparation (Neves, A.R., Pool, W.A., Mingote, A., Kok, J., Kuipers, O., and Santos, H).

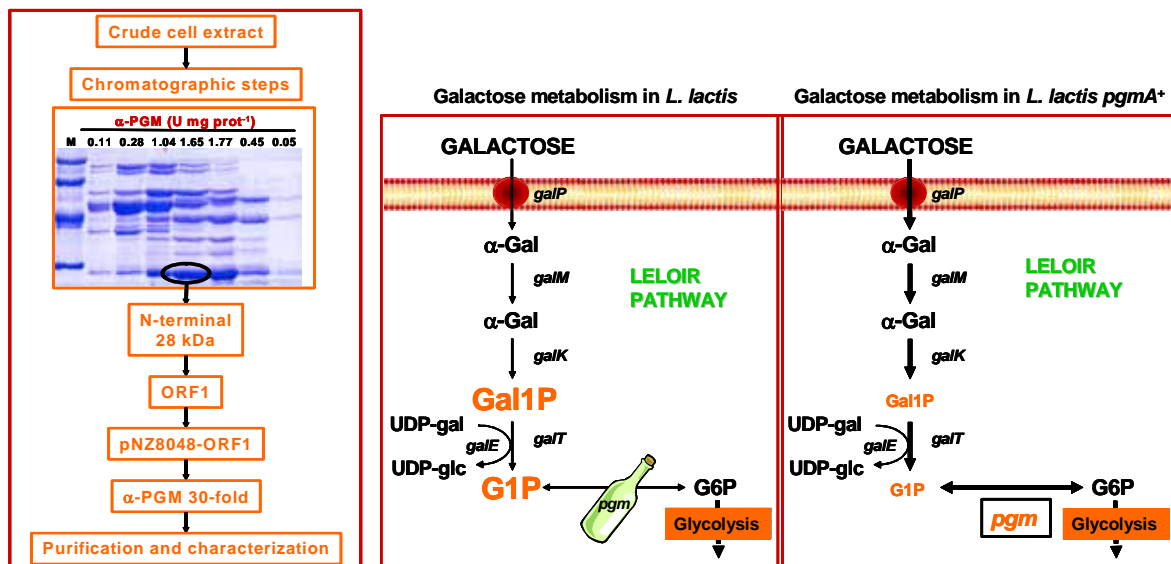

Virulence Potential of Dairy Enterococci.

Fátima Lopes : Antibiotic Stress and Virulence of Enterococci Laboratory.

In order to understand the virulence potential of dairy enterococci, 35 isolates from raw ewe's milk and traditionally fermented cheeses, identified as *E. faecalis*, *E. faecium*, *E. durans*, *E. dispar* and *E. hirae*, were screened for their capacity to produce gelatinase and for the presence of the genes *gelE*, *sprE*, *fsrA*, *fsrB* and *fsrC*. Studies correlating gelatinase production with maintenance and subculture of the isolates in the Laboratory environment, and growth in different media were performed. These studies were conducted with two dairy isolates identified as *E. faecalis* and *E. durans*, and one clinical isolate, *E. faecalis* OG1-10. RT-PCR was used for the detection of transcripts of the above mentioned genes. Results demonstrated that the virulence factor gelatinase is disseminated among the genus *Enterococcus* and that dairy isolates are capable of producing gelatinase at comparable levels with clinical isolates, although this capacity is easily lost during conservation by freezing in the laboratory. Therefore, the gelatinase production potential of dairy enterococci may be underestimated. The gene *gelE* was present in all studied isolates. The same was observed for the *fsr* operon, either complete or incomplete, revealing that the gelatinase genetic determinants, so far only described in *E. faecalis*, are a common trait in the genus. This work describes for the first time the detection of the complete Fsr-GelE operon in other species than *E. faecalis*, namely *E. faecium* and *E. durans*. The loss of expression of this virulence factor under laboratory culture conditions correlated with the loss of one or more genes of the regulatory *fsr* operon, although the gene *gelE* was maintained, demonstrating that a complete *fsr* operon is required for a positive GelE phenotype. Independently of the detection of any gelatinase activity, if both *gelE* and the complete *fsr* operon are present in the cell, all genes are transcribed, as revealed by RT-PCR, suggesting that regulation of gelatinase activity can also be post-transcriptional. Overall, these findings re-open the issue of food safety of enterococci and reinforce the need for further study of the mechanisms responsible for triggering the virulence factor gelatinase in non-pathogenic enterococcal environmental isolates.

Different combinations of GelE phenotypes and genotypes found in the enterococcal isolates.

Nº of isolates	Species ^c	<i>gelE</i> ^a	<i>fsr</i>		Phenotype
			<i>sprE</i> ^a	operon ^b	
4	1 fa, 2 d, 1 sp	+	+	+	GelE +
12	1 fa, 4 fe, 5 d, 2 spp	+	+	+	GelE -
0		+	-	+	GelE +
25	1 fa, 12 fe, 4 d, 2 di, 1 h, 5 spp	+	-	+	GelE -
0		+	-	-	GelE +
29	2 fa, 4 fe, 13 d, 3 h, 4 spp	+	-	-	GelE -

^a As determined from PCR results: +, presence; -, absence. ^b As determined from PCR results: +, if all three *fsr* genes were present; -, if at least one of the three *fsr* genes was absent. ^c fa, *E. faecium*; fe, *E. faecalis*; d, *E. durans*; di, *E. dispar*; h, *E. hirae*; sp/spp, *Enterococcus* sp.

Development and Characterization of Prodrug Systems.

Ana Luísa Simplício : Analytical Laboratory (IBET).

The prodrug approach has found many applications in the mitigation of pharmaceutical liabilities of carboxyl- or hydroxyl-bearing drugs where the ester prodrug design is particularly effective. Building of chemically or enzymatically vulnerable amino derivatives, which are very versatile and can be used as prodrugs, has proved, however more difficult.

A promising option which involves a pH sensitive β -aminoketone has been previously developed^{1,2}. We are now modifying this system in order to prepare new chemical entities which behave in the same manner and which allow for a wider range of possibilities for modulation of the release rates. The introduction of a group that is susceptible to enzyme hydrolysis and which imparts targeting properties to the original system is also under consideration. Moreover the applicability of such systems for the protection of the amino groups in therapeutic peptides will also be studied.

The characterization and modelling of these systems in terms of lipophilicity, ionization, pharmacokinetics and bioavailability is of paramount importance. HPLC and capillary electrophoresis are the methodologies used for the determination of these chemical constants and the evaluation of the release profiles in buffer, enzyme solutions and biological fluids. Whenever necessary, chiral methods are used. Bioavailability evaluation is performed using *in vitro* transport models.

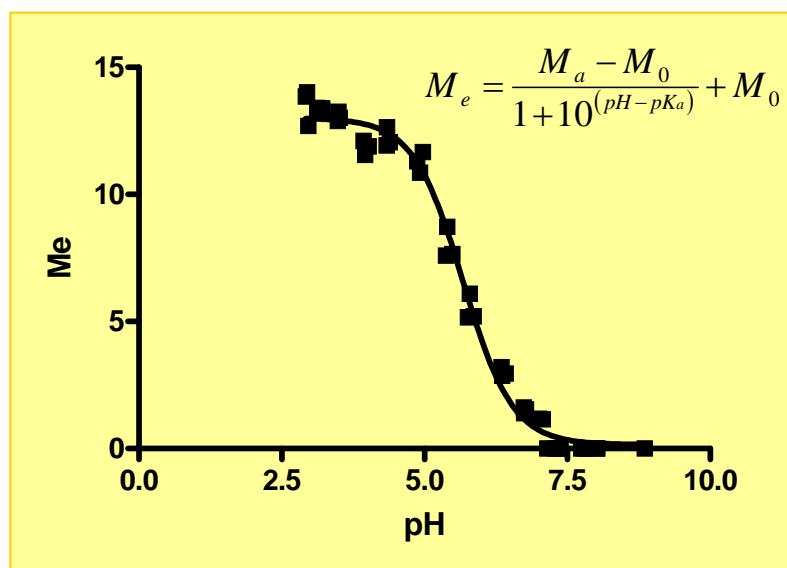

Figure 1: Adjustment of a Boltzmann sigmoid to the electrophoretic mobility data as a function of the pH for the determination of ionization constants

¹Ana Luísa Simplício, John F. Gilmer, Neil Frankish, Helen Sheridan, John J. Walsh and John M. Clancy, "Ionisation characteristics and elimination rates of some aminoindanones determined by capillary electrophoresis", *Journal of Chromatography A*, Volume 1045, Issues 1-2, 6 August 2004, Pages 233-238

²John F. Gilmer, Ana Luísa Simplício and John M. Clancy, "A new amino-masking group capable of pH-triggered amino-drug release", *European Journal of Pharmaceutical Sciences*, In Press

The First Gypsy-like Retrotransposon.

Margarida Pedro Rocheta : Pinus Laboratory.

Retrotransposons are mobile genetic elements which transpose replicatively through RNA intermediates. They are found in all major eukaryote divisions and comprise major fractions of the genomes of plants. The two long terminal repeat (LTR)-containing retrotransposon groups (Ty1-*copia* group and the *gypsy* group) and the non-LTR retrotransposons (also known as LINE elements) are all present in plant genomes and are potentially the more useful source of molecular markers. Retrotransposons have been found in a wide variety of organisms including insects, fungi, gymnosperms and angiosperms. They comprise highly heterogeneous populations, whose members frequently span different genera. Several retrotransposons have been shown to be highly polymorphic for insert location within plant species. These properties have been exploited in several molecular marker systems for genetic analysis in a wide range of plant species.

Retrotransposons appear to replicate in the same manner as retroviruses with transcription of an RNA intermediate initiating and terminating within LTRs that flank an interior coding region. Also similar to retroviruses, the interior region encodes gene products for reverse transcription and integration including a protease, a reverse transcriptase, RNase H and an integrase. The only difference between retro-viruses and retrotransposons may be an *env* gene present in retroviruses, which is required for making virus particles and for infecting cells. How these transposable elements have achieved their apparent ubiquitous distribution in eukaryote genomes without a mechanism of dispersal remains speculative.

A first complete ***gypsy-like retrotransposon*** sequence with 5976bp has been determined in *Pinus pinaster* and named ***PPRT1*** (*Pinus pinaster retrotransposon 1*). Putative gene products associated with retrotransposition appear to be encoded by a single reading frame and are in the same order as the *gypsy-like retrotransposons* and retroviruses. Regions immediately adjacent to LTRs have sequences (named PBS-primer binding site) and PPT (polypurine tract) required for cDNA synthesis. The PBS sequence is also complementary to the 3' sequence of a particular tRNA species.

Organization of *Pinus pinaster retrotransposon 1 (PPRT1)*

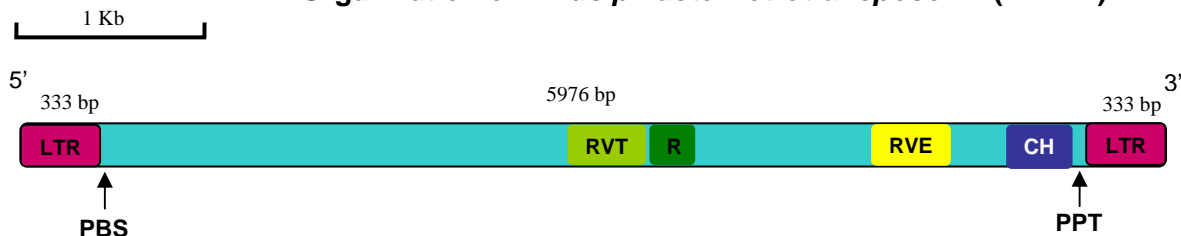

LTR, Long terminal repeat; **RVT**, Reverse transcriptase; **R**, RNase H; **RVE**, integrase; **CH**, Chromatin organization modifier. **PBS**, primer binding site a sequence complementary to the 3' sequence of a particular tRNA species. **PPT**, polypurine tract. Sizes of LTRs and interior region in nucleotide base pairs (bp).

A common feature of most retrotransposons is that they are activated by stress (*in vitro* cell or tissue culture) and environmental factors. Insertion of retrotransposons into coding sequences after cell culture indicates that retrotransposition may significantly contribute to somaclonal variation.

The ***PPRT1 retrotransposon*** sequence will be used to monitor retrotransposon activity during *in vitro* propagation of maritime pine. In addition, we aim to isolate and characterize new retrotransposon elements in *P. pinaster* genome and compare retrotransposon profiles during zygotic and somatic embryogenesis.

Differential Expression of Cell Wall Proteins of Medicago Associated with Wounding: the Identification of a Sub-set of Proteins Regulated by Peroxide.

Phil Jackson : Plant Cell Wall Laboratory.

The cell wall plays an important role in the plant responses to stress, involving the differential expression of a large variety of proteins, many of which remain unknown. We have used a proteomic approach to study wound-related changes in the wall proteome of the model legume species, *Medicago*, and identified a large number of protein spots displaying reproducible differential expression within 6 h after stimulus. By using the NADHox./peroxidase inhibitor, DPI, a sub-set of wound-responsive proteins dependent on the peroxide signalling pathway was identified. Time assays of DPI application revealed that the differential regulation of this sub-set of proteins was initiated by increases in endogenous O_2^- / H_2O_2 during the first 3 minutes after wound perception. Initial MALDI-TOF/TOF analyses have so far identified proteins with significant homology to a SOD, peroxidase, metalloprotein, callose synthase, putative kinase, and a number of unknown proteins. Ongoing MS analyses will provide us with a more detailed characterisation of the cell wall proteins associated with the earliest responses to wound-related stress in plants.

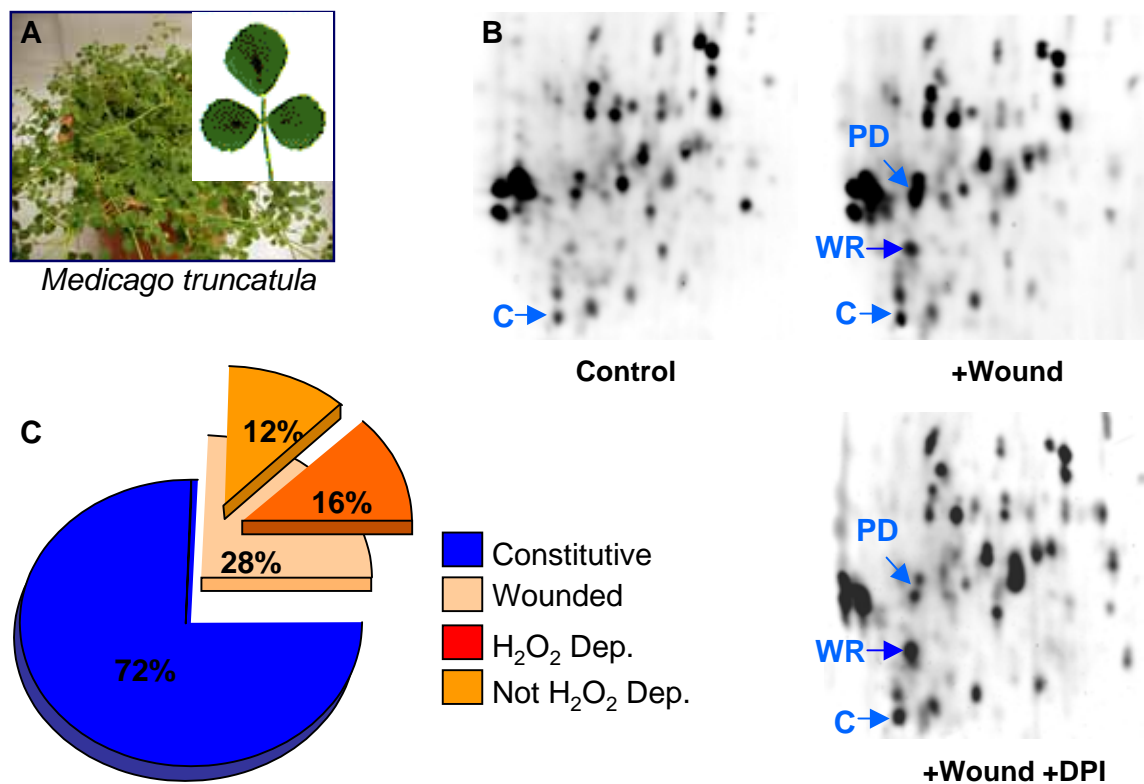
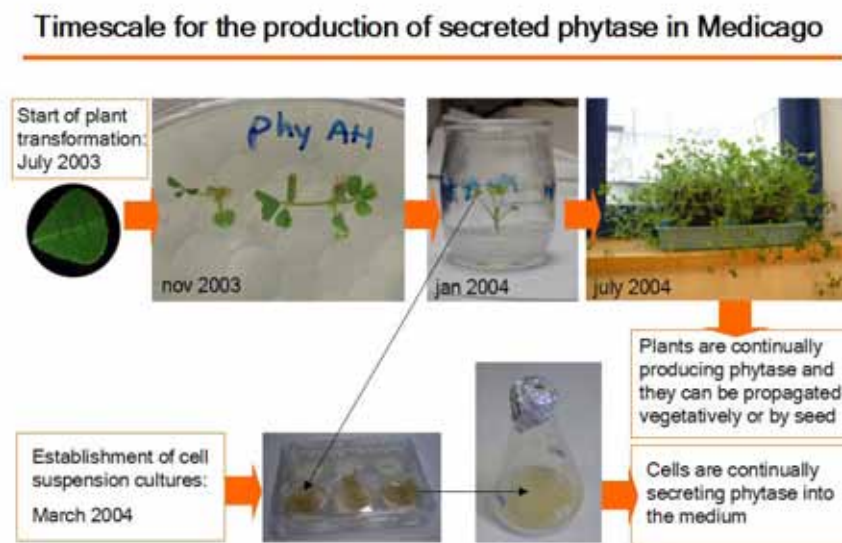

Fig. 1. Overview of the results so far: A) *Medicago* plant and leaf, B) Selected area of 2D electrophoretic gels displaying wound responsive (WR) and peroxide dependent (PD) changes in the wall proteome, C) Statistical analyses reveal that around half of the differentially regulated proteins can be related with peroxide signalling pathways.

Plants as Bioreactors: *Medicago truncatula* as an Emerging Production System.

Rita Abranches : Plant Cell Biology Laboratory.

Plants are emerging as a promising alternative to conventional platforms for the large-scale production of recombinant proteins. This field of research, known as molecular farming, is developing rapidly and several plant-derived recombinant proteins are already in advanced clinical trials. However, the full potential of molecular farming can only be realized if we gain a fundamental understanding of biological processes regulating the production and accumulation of functional recombinant proteins in plants. Recent studies indicate that species- and tissue-specific factors as well as plant physiology can have a significant impact on the amount and quality of the recombinant product.



We have explored the potential of the legume *Medicago truncatula* as an alternative production system, and our results show that this species offers significant advantages over other plants. We have generated transgenic plants of *M. truncatula* using an expression construct, which encodes the model glycoprotein, phytase A from the fungus *Aspergillus niger*. Phytase A is a heavily glycosylated, stable protein that functions in the hydrolysis of phytic acid. This system has potentially important commercial applications since phytic acid is largely indigestible by monogastric animals and is a major factor hindering the uptake of a range of minerals. Therefore, engineering food and feed crops to produce heterologous phytase can be used to improve the mineral bioavailability and reduce phytate excretion. We have used identical constructs for the expression of recombinant phytase in several species including tobacco and *M. truncatula*. Transgenic plants, which gave the highest yields of phytase were selected from each species for comparative studies. We found a remarkably high content of phytase (at least 0.5 mg phytase per gram of leaves) in *M. truncatula*. The activity of the protein was more than three times higher in *M. truncatula* leaves than in tobacco. Post-translational modifications and subcellular deposition were also assessed. In addition, alternative expression systems, such as seeds and cell suspension cultures derived from transgenic plants, are now under evaluation.

CHEMISTRY

CHEMISTRY DIVISION: Objectives and Activities.

The general scientific objectives of the Chemistry Division are the synthesis, characterization and identification of natural and synthetic molecules and chemical processes which have a relevance to Biology and related Life and Environmental issues.

Although not comprehensively covering all the aspects of this extremely wide area, the Chemistry Division makes a significant impact in the following fields;

- Theory and modeling of molecules and chemical reactions (Laboratory of M. J. Calhorda, Theoretical and Inorganic Chemistry);
- Selective synthesis and catalysis of organic, inorganic organometallic molecules of potential pharmaceutical interest (Laboratories of C. Maycock, Organic Synthesis; R. Delgado, Coordination and Supramolecular Chemistry; C. Romão, Organometallic Chemistry; Beatriz Royo, Catalysis)
- Characterization and kinetics of chemical processes in biological interfaces, membranes and aggregates by photophysical methods (Laboratory of E. Melo, Microheterogeneous Systems);
- Raman spectroscopy of metalloenzymes and biologically relevant molecules and materials (Laboratory of R. Franco, Raman Spectroscopy).

Throughout 2004, the existing lines of research were continued but no new projects were introduced as a result of the absence of appropriate calls at the national level. A reinforcement of the operation on Catalysis that was submitted within a wide Network of Excellence failed to get financing after a successful first round of evaluation because the whole catalysis component in the call for Nanotechnology was cancelled.

On the positive side new NMR equipment has been attributed to the Division through the national program for scientific re-equipment. Installation is hopefully expected for 2005.

The **Theoretical and Inorganic Chemistry** Laboratory addressed several problems using DFT and TD-DFT methods, namely: the electronic structure and photoreactivity of transition metal clusters; the electronic structure of Co(III) Werner complexes; the luminescence of polynuclear gold complexes; redox induced ring slippage in $\text{InMo}(\text{CO})_2(\text{N-N})$ complexes. It also undertook mechanistic investigations of catalytic reactions (olefin epoxidation and alkyne cyclotrimerization), as well as of dihydrogen activation by Fe-Ni hydrogenases and binuclear complexes (Rh, Ir) containing sulfur ligands. On the experimental front the Laboratory studied polynuclear complexes derived from ferrocenyl-based ligands and commenced spectroelectrochemical studies on Mo(II) complexes.

The **Organic Chemistry** Laboratory carried on successful enantioselective syntheses of a range of natural products with biological activity. This includes piscidic acid, intermediates *en route* to canadensolide, and optically active amino alcohols and lactones from mannitol, that are potential enzyme inhibitors. The synthesis of natural and unnatural solutes for the stabilisation of proteins and other natural polymers has continued within the EU CRAFT project coordinated by STAB with the emphasis moving from mannose to glucose and further to disaccharides and inositol derivatives. Simultaneously, new synthetic methodologies for the enantioselective synthesis of chiral ligands were studied. Collaboration with industry brought three new projects during 2004 and two new projects for 2005.

The **Coordination and Supramolecular Chemistry** Laboratory has made progress in the synthesis and testing of supramolecular anion recognition species for environmental decontamination applications. The inclusion of linear substrates was studied for the macrocycle $\text{Me}_2[28]\text{py}_2\text{N}_6$ with two sets of dicarboxylate anions differing in shape, size and rigidity; an aliphatic (oxalate, malonate, succinate, glutarate and adipate), and an aromatic series (phthalate, isophthalate, terephthalate (tph), and 4,4'-dibenzoate). Some tetraazamacrocycle methylpolyphosphonate compounds have been explored for diagnostic and/or therapeutical radiopharmaceuticals using metal radionuclides. Biodistribution studies in mice have indicated bone uptake for ^{153}Sm and ^{166}Ho radio-complexes.

The **Organometallic Chemistry** Laboratory set forth the research lines on oxygen transfer catalysis with organometallic oxides and the synthesis of organometallic drugs. The excellent catalytic activity of CpMoO_2X complexes was extended beyond olefin epoxidation to sulfide and N-heterocyclic oxidation. One patent was submitted on organometallic drugs for the treatment of cancer; these have been successfully tested on human stomach/colon cancer cell lines, and another one is ready for submission.

The **Catalysis** Laboratory, established during the course of this year with rather limited resources, has been able to report highly interesting examples of a new kind of catalytic application of oxo-complexes, namely the carbonyl hydrosilylation. Exciting developments are in prospect for this new field, namely in the area of hydrogenation.

The Laboratory of **Microheterogeneous Systems** remained focused on the study of the physical-chemical properties of molecular assemblies and their applications. This year a formulation for protein micro-encapsulation was developed and an adenovirus mucosal vaccine for cattle is now under *in vivo* test. This work will be extended with the study of the mechanism of aggregation of polymers in aqueous solution and supercritical fluids. The study of the thermo and prototropism of model systems of the stratum corneum lipid matrix, was continued and will be extended to the structural characterization of the lipid aggregates formed. In a similar manner, the acid-base properties at soft interfaces and interaction of pharmaceutical drugs with bilayers and lamellar structures of stratum corneum lipids are under active research.

The **Raman Laboratory** installed a new spectrometer that allows resonance Raman (RR) experiments with a laser beam of any frequency and with better resolution than the former. The 413 nm line of the available Kr+ laser, allows RR of porphyrin- and heme-containing biosystems as well as responsive chemical systems. Electrochemistry coupled to SERRS (Surface Enhanced Resonance Raman Spectroscopy) of membrane proteins has been the major research line with two facets, i) extension of the work on cytochromes c3 to type II cytochromes c3, a membrane-anchored protein, with synthesis of new ligands for SERRS, namely, NTA-His-tag-binding and glycoconjugates; ii) SERRS spectroscopic studies of different aa3, caa3 and cbb3 -type bacterial oxidases aimed at the physico-chemical characterization of these complex enzymes and their subunits.

The Highlight for the Laboratory of Beatriz Royo is included in the section on the Laboratório Associado.

CHEMISTRY DIVISION – STAFF.

Laboratory: Homogeneous Catalysis

Head of Laboratory: Beatriz Royo Cantabrana (see also Laboratório Associado Section)

Laboratory: Organometallic Chemistry (Oxo-complexes/ ring slippage)

Head of Laboratory: Carlos C. Romão

Research Team:

Ana Cristina Silva Fernandes	Ph.D.
Marta Norton de Matos	Post-Doc
Marta Ramilo Abrantes	Ph.D.Student
Cláudia Cristina Lage Pereira	Ph.D.Student
Tiago Lourenço	Ph.D.Student
Zeljko Petrovski	Ph.D.Student
João Seixas	Undergraduate trainee / Ph.D. Student (from September)
Márcia Matos	Undergraduate trainee
Ricardo Fernandes	Undergraduate trainee

Laboratory: Organic Synthesis (Asymmetric synthesis)

Head of Laboratory: Christopher David Maycock

Research Team:

Maria Rita Bordalo Ventura	Post-Doc
Hovsep Avedissian	Post-Doc
Jorge Wahnou	Ph.D.Student
Sofia Miguel	Graduate Student (from Industry)

Laboratory: Microheterogeneous Systems (Chemical kinetics/ mesophases)

Head of Laboratory: Eurico Melo

Research Team:

Antonio Manuel Gonçalves Lopes	Ph.D.
Rute Cristina da Silveira Mesquita	Ph.D. Student
Sofia Leite de Souza	Ph.D. Student
Maria Helena Lopes Lameiro	Ph.D. Student
Sónia Lopes	Graduate Student
Ana Paula Silva	Graduate Student

Laboratory: Theoretical and Inorganic Chemistry (DFT calculations / polynuclear complexes)

Head of Laboratory: Maria José Calhorda

Research Team :

Susana Quintal	Post-Doc
Pedro Vaz	Post-Doc
Maria João Pires da Silva	Master Student
Paulo Jorge Costa	Ph.D. Student
Márcia Mora	Ph.D. Student
Clara Cabrita	Undergraduate
Nuno Bandeira	Undergraduate

Laboratory: Raman spectroscopy

Head of Laboratory: Ricardo Franco

Research Team :

Roberto Di Paolo	Post Doc
Smilja Todorovic	Post-Doc
Vesna Prosinecki	Graduate Student
Inês Gomes	Graduate Student

Laboratory: Co-ordination and Supramolecular Chemistry (Macrocyclic compounds /
Supramolecular assemblies)

Head of Laboratory: Rita Delgado

Research Team:

Xiuling Cui	Post-Doc
Patrícia dos Santos Antunes	Ph.D. Student
Krassimira Passos Guerra	Ph.D. Student
Feng Li	Ph.D. Student
Sílvia Ferreira de Carvalho	Ph.D. Student
Luís Miguel Lima	Ph.D. Student

Organometallic Oxide Catalysts for yet Uncatalyzed Reactions.

Carlos Romão : Organometallic Chemistry Laboratory.

The discovery of catalysts for reactions that are only known to Organic Synthesis in a stoichiometric fashion is a frontier topic where both design and serendipity go hand-in-hand. Organo-metallic oxides have been shown to be able to perform a number of such new catalytic reactions with great success. Our continuing studies in this area revealed that $[\text{ReMeO}_2(\eta^2\text{-alkyne})]$ complexes enable the mimetic Wittig-like synthesis of olefins from diazo compounds and aldehydes (olefination) even for compounds that do not react under the standard Wittig conditions, that is, that correspond to unreactive ylides. Bypassing ylide formation these catalysts afford aldehyde olefination of substrates incompatible with highly basic Wittig conditions.

A. M. Santos, F. M. Pedro, A. A. Yogalekar, I. S. Lucas, C. C. Romão, F. E. Kühn, *Chem. Eur. J.* **2004**, *10*, 6313 – 6321.

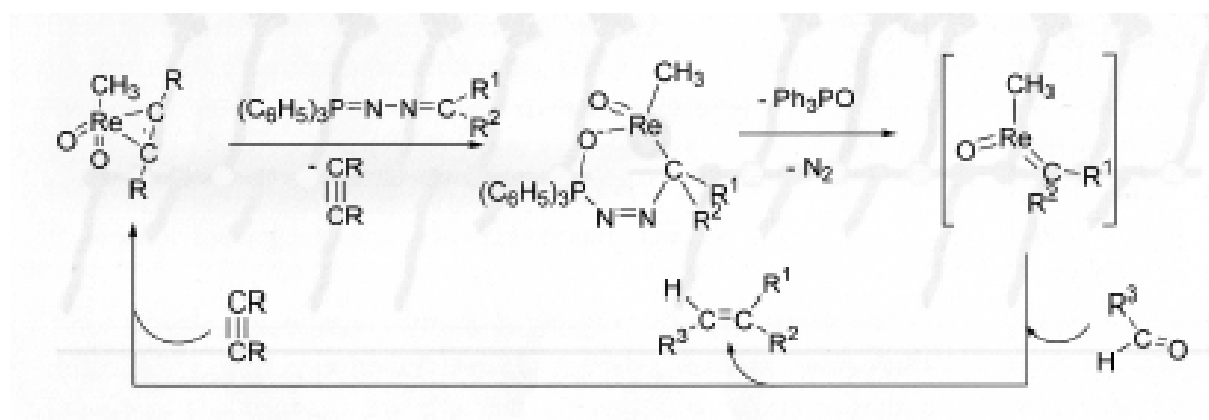

Studies on the Synthesis of Natural Products.

Chris Maycock : Organic Synthesis Group.

Previous synthetic studies on polyoxygenated cyclohexane natural products have been reviewed and widely cited in Chem. Rev. **2004**, *104*, 2857-2899.

The study of the enolates formed from tartaric acid and glyceric acid thioester derivatives has been continued. The chiral memory technology has been applied to the synthesis of natural products such as Piscidic acid, which is one of a series of structurally related compounds with biological activity. The correct stereochemistry was obtained directly and efficiently. Similarly a novel chiral acetal (dioxolane) has been stereo-selectively hydroxyalkylated with kinetic resolution at an alpha-benzyloxyaldehyde. This can be further elaborated in a stereo-controlled manner to bicyclic lactones related to the natural product canadensolide. The aldol products derived from glyceric acid cyclise to form novel chiral trioxabicyclic-(2.2.2)-octanes.

The use of diacetals derived from tartaric acid for the synthesis of chiral ligands for metal catalysed asymmetric transformations has continued with studies on the addition of alkyl zincs to aldehydes. Satisfactory, but not extraordinary, enantiomeric excesses were produced using a novel mixed N,O ligand.

The formation of optically active amino alcohols and lactones from mannitol has also been carried out and a series of natural lactones and aminoalcohol analogues have been prepared. These latter are potential enzyme inhibitors.

The synthesis of dehydrodecalin structures has also continued and the rearrangement of related allylic alcohols studied in addition to the effect of substitution and Lewis acid catalyst on the product distribution. The possibility of using this rearrangement as a switch to activate molecules for the controlled generation of unstable intermediates such as enediynes as needed, is also under study.

The synthesis of natural and unnatural solutes for the stabilisation of proteins and other natural polymers has continued within the EU CRAFT project coordinated by STAB. The emphasis has now moved from mannose to glucose derivatives but the alpha glycoside linkage is retained. This poses a severe problem with glucose and short syntheses are difficult because of the necessity to carry out extensive and selective protection of the various hydroxyl groups. We have successfully produced glucosyl glycerate and analogues and are now moving on to disaccharides and inositol derivatives.

The formula below depicts a key intermediate in the synthesis of fused dilactones, obtained in an optically pure form from tartaric acid. Spontaneous self organization of this compound produces the fine crystals shown in the right hand panel.

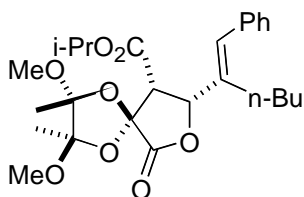

Diffusion Controlled Reactions in Biological Membranes.

Eurico Melo : Micro-heterogeneous Laboratory.

There is a widespread belief that a reduction in dimensionality confers a kinetic advantage on a diffusion-controlled reaction; more specifically, diffusion-controlled reactions occurring in biological membranes are customarily believed to be inherently faster than those taking place in an aqueous environment. Doubts have often been aired as to whether this holds in real biological systems, where the number of traps is usually very large; or whether the rate enhancement only happens for very large compartments, at least larger than those existing in a cell. We addressed these questions theoretically and with Monte-Carlo simulations and concluded that in most cases there is no real enhancement in the reaction rate in the conditions usually found in living systems. The same happens for nano and micron-sized reaction compartments. So, living organisms may find many benefits from being highly compartmentalized, but these certainly do not include an enhancement of the speed of reactions (J. Martins, E. Melo, K.R. Naqvi, *J. Chem. Phys.*, **120**(2004)9390).

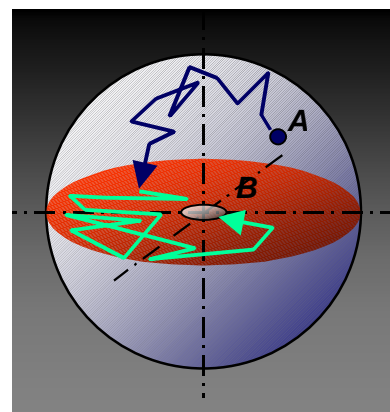

Reaction between molecule **A**, diffusing in a spherical volume (cell compartment), and molecule **B** located in a plane (biologic membrane).

An important objective in the design of pharmacological active compounds is their ability to efficiently permeate and interact with biological lipid membranes, from which can depend on either pharmacological or adverse effects of the drugs.

The interaction of a solute with a dispersed lipid phase is conceptually related to a Nernstian distribution between two non-miscible liquids. By this approach, only a partition of the solute is conceptually valid, and all the parameters contributing to the interaction extent, - electrostatic, hydrophobic, steric, etc. - are enclosed in the notion of partition and globally quantified. Moreover, all these parameters are assumed to be non-variable with changes in concentration. On the other hand, the consideration of a binding mechanism between the solute and the lipid, describes the existence of binding sites in the membrane, receptor-like locals that accommodate the ligand. In fact, under experimental conditions in which the lipid/drug ratio is low, saturation phenomena are observed, and the apparent partition coefficients are lower than the real partition coefficient.

We have developed a model including the two phenomena, binding and partition, for the interaction between drugs and lipid membranes. The process is better described by a binding isotherm, characterized by a number of lipid molecules associated with each drug molecule, n , and by a binding constant. The introduction of the parameter n allowed flexibility into the binding curve, and showed that there actually was a change in association number along the binding isotherm, which is a parameter not possible to envisage in a simple partition model. (Matos, C., Lima, J., Reis, S., Lopes, A., Bastos, M. *Biophys. J.* 86(2004)946)

Activation of Dihydrogen in Biological and Industrially Relevant Systems - Organometallic Models.

Maria José Calhorda: Theoretical and Inorganic Chemistry Laboratory.

Hydrogenases reversibly catalyze the transformation of H_2 into H^+ . Activation usually takes place at binuclear metal centers and involves sulfur ligands, as in the Fe-Ni hydrogenase, with the formation and/or cleavage of S-H bonds. In hydrodesulfurization, sulfur is removed from fossil fuels by catalysts containing molybdenum.

The coordinatively unsaturated rhodium dimer $[(\text{triphos})\text{Rh}(\mu\text{-S})_2\text{Rh}(\text{triphos})]^{2+}$, **1**, [triphos = $\text{CH}_3\text{C}(\text{CH}_2\text{PPh}_2)_3$], activates dihydrogen reversibly and heterolytically, providing a model for the biological system. The final product $[(\text{triphos})(\text{H})\text{Rh}(\mu\text{-SH})_2\text{Rh}(\text{H})(\text{triphos})]^{2+}$, **2**, has been structurally characterized.

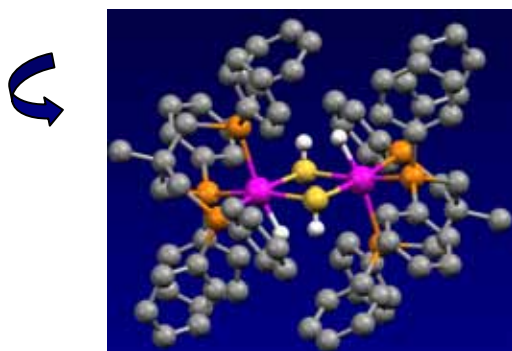

DFT calculations on a model complex $[(\text{PH}_3)_3\text{Rh}(\mu\text{-S})_2\text{Rh}(\text{PH}_3)_3]^{2+}$, **1c**, complemented by NMR studies, enabled the proposal of a mechanism. At first the H_2 molecule is coordinated to Ir (**4**) and heterolytically split (**5a**), followed by coordination of another H_2 molecule to the second Ir center (**7**), which also splits heterolytically.

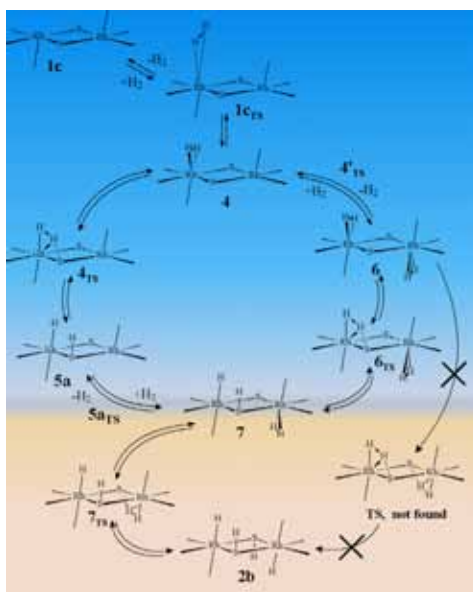

Activation of Molecular Hydrogen over a Binuclear Complex with Rh_2S_2 Core: DFT Calculations and NMR Mechanistic Studies, A. Ienco, M. J. Calhorda, J. Reinhold, F. Reineri, C. Bianchini, M. Peruzzini, F. Vizza, C. Mealli, J. Am. Chem. Soc. 126, 2808-2819 (2004).

Application of Resonance Raman (RR) and Surface Enhanced RR Spectroscopy to the Study of Heme-containing Enzymes and Enzyme Complexes.

Ricardo Franco : Resonance Raman Laboratory.

Resonance Raman spectroscopy was used to investigate conformational differences in the hemes of Type I ferricytochromes c_3 , electron transfer tetra-heme proteins isolated from the cytoplasm and membranes of sulfate reducing bacteria of the *Desulfovibrio* (*D.*) and *Desulfomicrobium* genera. Comparative analysis of the low frequency region RR spectra from different ferricytochromes c_3 , in the figure, revealed important shifts for lines assigned to vibrations of the covalent heme-protein linkage [(C_aS)] and revealed a close relationship with the size of the peptide segment between the heme-binding cysteines.

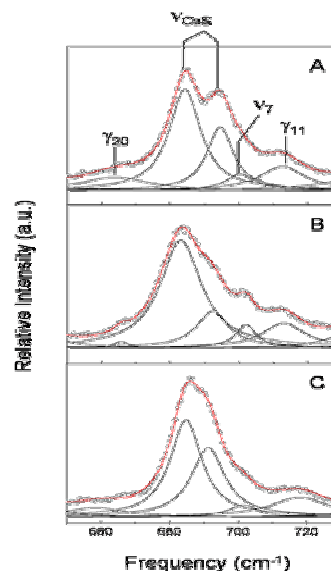

Type I (Tpl- c_3) and Type II (TpII- c_3) cytochromes c_3 isolated from the soluble (Tpl- c_3) and membrane fractions (TpII- c_3) of the sulfate reducing bacterium *D. vulgaris* Hildenborough, were electrostatically adsorbed on silver electrodes coated with self-assembled monolayers (SAMs) of 11-mercaptoundecanoic acid and 11-mercaptoundecanyl-beta-maltoside. The latter SAM mimics the structure of dodecylmaltoside (DM), a detergent used to solubilize TpII- c_3 , and revealed to be remarkably effective for the study of the redox equilibria of the adsorbed proteins by Surface Enhanced Resonance Raman Spectroscopy (SERRS). SERR spectra of the different adsorbed cytochromes c_3 were analyzed as function of the potential applied to the electrode. In order to obtain the redox equilibria for the different species, the SERR spectra were subject to a component analysis using Lorentzian deconvolution.

From this analysis it was possible to determine different redox potentials for the hemes of different cytochromes c_3 and values were compared with data obtained from NMR experiments for Tpl- c_3 or from UV/visible spectra for TpII- c_3 .

Two completed studies on *P. putida* cytochrome P450 and *A. ambivalens* quinol oxidase aa_3 gave very interesting insights into redox properties and the effects of electric field on redox potentials of these two enzymes. The ongoing project on RR, SERR spectroscopic studies of different aa_3 , caa_3 and cbb_3 -type bacterial oxidases, has as its aim the physico-chemical characterization of these complex enzymes and their subunits. A new approach in immobilization of cbb_3 via His tag has been used, allowing for application of SERR and redox titrations followed by this spectroscopic method on the enzyme in a lipid reconstituted environment, in order to monitor its catalytic cycle *in vitro*.

Macrocyclic Compounds for Molecular Recognition of Pollutant Anions and for Radiopharmaceuticals.

Rita Delgado : Coordination and Supramolecular Chemistry Laboratory.

Anions play important roles in a variety of fields, such as the environment, health and industry. Many anions are pollutants of the environment, encouraging the development of novel synthetic receptors displaying anion selectivity. The recognition of anionic substrates requires complementary positively charged or electron-deficient sites to form electrostatic, hydrophobic, hydrogen bonding, π - π stacking, or *van der Waals* interactions. In order to gain further insights into the features that control the inclusion of linear substrates we tested $\text{Me}_2[28]\text{py}_2\text{N}_6$ with two sets of carboxylate anions differing in shape, size and rigidity; an aliphatic series (oxalate, malonate, succinate, glutarate and adipate), and an aromatic series (phthalate, isophthalate, terephthalate (tph), and 4,4'-dibenzoate).

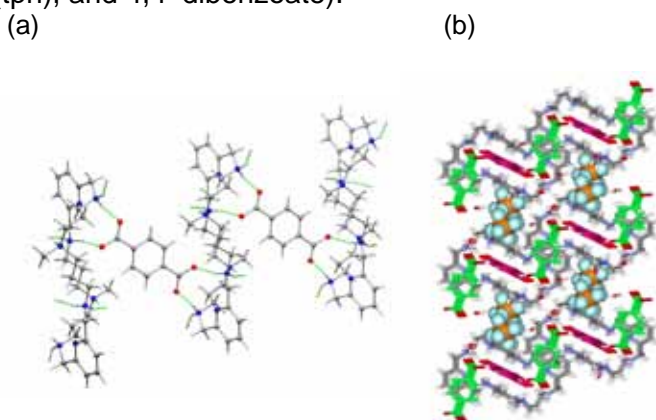
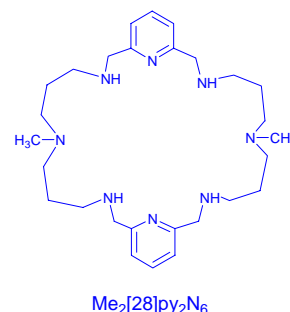
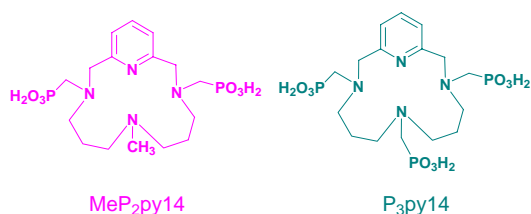

Fig. 1 Crystal building of $(\text{H}_6\text{Me}_2[28]\text{py}_2\text{N}_6).(\text{tph})_2(\text{PF}_6)_2.4\text{H}_2\text{O}$. (a) 1-D dimensional chain resulting from the interaction *via* hydrogen bonds of $(\text{H}_6\text{Me}_2[28]\text{py}_2\text{N}_6)^{6+}$ and the first independent tph anion. (b) crystal packing diagram showing the disposition of the tph^{2-} and PF_6^- anions. Only the octahedrally-disposed fluorine atoms with the major occupancy are shown.

Some tetraazamacrocycle methylpolyphosphonate compounds have been explored for diagnostic and/or therapeutic radiopharmaceuticals using metal radionuclides.



Both ligands have high overall basicity and their complexes have high thermodynamic stability constants. At pH 7.4 the highest pM values were found for solutions containing the compound P_3py_{14} . The ^{153}Sm and ^{166}Ho radiocomplexes are hydrophilic and have a significant plasmatic protein binding. Biodistribution studies in mice indicated a slow rate of clearance from blood and muscle and a very slow rate of total radioactivity excretion. Some bone uptake was observed for complexes with $\text{MeP}_2\text{py}_{14}$ and P_3py_{14} , which was enhanced with time and number of methylphosphonate groups

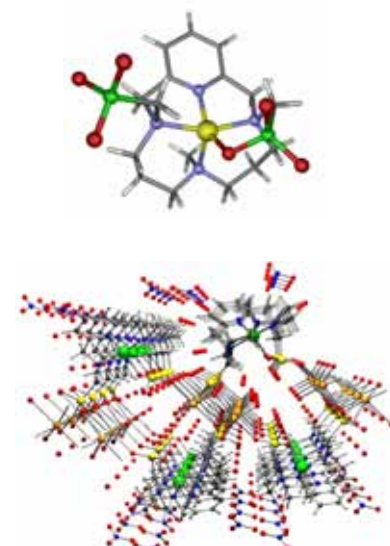

Fig. 2 A view of X-ray structure of $[\text{Cu}(\text{HMeP}_2\text{py}_{14})]$ and its crystal packing in a view down the y axis showing the open channels.

BIOLOGY

BIOLOGY DIVISION: Objectives and Activities.

Microbial Genetics, Microbial Development, Microbial Physiology, Control of Gene Expression, and Glycobiology are the main subjects of research of the 9 teams in this Division. Most of the expertise is focused on bacteria and archaea, but one of the teams studies protein glycosylating pathways in mammalian cells. In 2004 three young research leaders joined this Division to reinforce the areas of Microbial Pathogenesis, Microbial Epidemiology and Microbial Physiology.

Studies performed at the Laboratory of Molecular Genetics (H. de Lencastre) on **molecular mechanisms** responsible for **antibiotic resistance** and on **molecular epidemiology** represent a highly visible research area within this Division and most studies have direct social impact. The Laboratory has been the centre of multinational projects supported by the EC – project EURIS (1999-2003) and its continuation project PREVIS (2004-2007) – the aim of which is to understand the molecular mechanisms of bacterial colonization and to test the efficacy of interventions that would lower the carriage rate of drug resistant and virulent strains of *Streptococcus pneumoniae* by healthy children attending day care centres. Day care centres represent a major ecological reservoir of *S. pneumoniae* and reduced carriage should also reduce both pediatric and adult disease by this dangerous pathogen. Extensive studies are also ongoing to understand the mechanism of epidemic behaviour and evolution of multidrug resistant clones of *Staphylococcus aureus* in hospitals and in the community.

Previous studies at the Laboratory of Molecular Genetics demonstrated that expression of the beta-lactam resistant phenotype in *S. aureus* involves not only the resistance gene *mecA* but also a surprisingly large number of determinants in the genetic background of the bacteria, which appear to be part of a stress response pathway. The transcription of three such auxiliary genes – *murE*, *murF* and *pbpB* – was put under the control of inducible promoters in order to test the effect on the resistant phenotype. This novel experimental system will be analysed for mRNA expression profiles using DNA microarrays.

Research in the Microbial Development group (A. O. Henriques) focuses on the analysis of the regulatory circuits coupling **gene expression to morphogenesis** during spore formation in *Bacillus subtilis*, and on the molecular mechanisms that govern **assembly of the spore surface layers**. Recent research highlights include: *i*) the finding that the **cell division** gene *divIB* is essential for normal prespore **chromosome segregation** at the onset of spore development, even under genetic conditions in which *divIB* is dispensable for cell division; *ii*) the finding that the prespore-specific σ^G form of RNA polymerase and not σ^G itself is inactive prior to a key intermediate stage in spore **morphogenesis**, and is activated by a **cell-cell signalling pathway** emanating from the mother cell; *iii*) the characterization of the function of a **transglutaminase** which is assembled at the surface of the developing spore and promotes **cross-linking** of specific spore coat protein component; *iv*) the discovery that **undomesticated** gut-associated strains of *B. subtilis*, appear to **sporulate constitutively**, suggesting that signals other than those (cell-density, cell-cycle, metabolic, and others) known to operate under Laboratory conditions may influence entry into this developmental pathway in certain ecosystems.

The main area of interest in the laboratory coordinated by I. Sá Nogueira is the analysis of the mechanisms through which the cell senses nutrient availability and transmits that information to the level of **gene expression**. The research focuses on the mechanisms of **transcriptional regulation** that govern the expression of genes involved in **carbohydrate metabolism** in the Gram-positive model organism *B. subtilis*. More specific objectives include: structure-function analysis of the transcription factor AraR, the key-master regulator of arabinose utilization and uptake of galactose and xylose; genetic and biochemical characterization of extracellular-degrading enzymes of arabinose-containing polysaccharides, transport systems, and intracellular enzymes involved in further catabolism; elucidation of the mechanisms that underlie carbon catabolite repression of the arabinose regulon.

To elucidate mechanisms that **control gene expression** is the main objective of the team coordinated by C. M. Arraiano, focussing on post-transcriptional control of gene expression and **control of mRNA degradation**, a research topic of major current interest. *E. coli* is the primary model organism, but studies with *L. lactis* and eukaryotes (*Drosophila*) have also been performed. For instance, this team has recently cloned and characterized RNase III from *L. lactis*, and has discovered and characterized the exoribonuclease *tazman* from *Drosophila*. They have also shown that *E. coli* RNase R is a cold shock protein involved in the maturation of SsrA/tmRNA, an important small stable RNA involved in trans-translation (a protein quality control system that involves protein tagging and ribosome rescue). Main specific objectives are: functional and structural studies of **ribonucleases**; **RNA processing** and RNA degradation; **small RNAs**; **quality control**; metabolism of the **poly(A) tail in bacterial mRNAs**; control of **cell division** in *E. coli*; control of gene expression under **stress and stationary phase**.

The Laboratory of **Cell Physiology & NMR** (H. Santos) uses *in vivo* and *in vitro* **NMR** as a tool to study microbial physiology. Lactic Acid Bacteria and hyperthermophilic bacteria and archaea are the two major objects of research in this group. *In vivo* NMR has been used to measure *on line* the dynamics of intracellular pools of glycolytic intermediates in *Lactococcus lactis* strains with the aim to provide reliable *in vivo* data to be used as guidelines for efficient **metabolic engineering** strategies in **dairy bacteria**. The “applied goal” of these studies is to redirect carbon fluxes to the *in situ* production of metabolites with beneficial properties (mannitol, trehalose) or the removal of undesired products (biogenic amines, galactose). A more fundamental goal is to characterise central metabolism and regulatory networks in *L. lactis* taking advantage of global approaches.

Know-how on the **physiology of hyperthermophiles** has been established in the same team. The main objectives of this research line are; genetic and biochemical characterization of biosynthetic pathways of compatible solutes; identification of biochemical strategies for adaptation to hot environments; development of microbial cell systems for the production of hypersolutes; characterisation of the molecular basis for protein stabilisation by compatible solutes; identification and characterisation of novel compatible solutes; characterisation of transport systems for hypersolutes. The team is the inventor of five patents on the application of compatible solutes of hyperthermophiles for the preservation of biomaterials.

Protein transport and glycosylation in mammalian cells is the main topic in the team coordinated by J. Costa. Work on the regulation of glycosylation, more specifically fucosylation, in mammalian cells has been developed. The team has elucidated the importance of the cytoplasmic domain of human fucosyltransferase III for its localization in the Golgi. Ongoing studies consist of the characterization of fucosyltransferase expression and *in vivo* activity in ovarian carcinoma cells and differentiating neuronal cells. Work on protein transport and glycosylation associated with neurodegenerative diseases is currently under development. The importance of nicastrin glycosylation and intracellular targeting for the activity of the gamma-secretase complex associated with Alzheimer's disease is being studied. On the other hand, initial studies on the proteome and glycome of amyotrophic lateral sclerosis have shown increases of the acute-phase glycoprotein alpha2-macroglobulin during the course of the disease.

The laboratory of **Microbial Pathogenesis and Cell Biology** (S. R. Filipe) is one of the newly established research groups, formally set up in October 2004. The main interest of the laboratory is the relationship of Gram-positive pathogens and their hosts, namely the role of cell wall synthesis and turnover in the process of host colonization and infection. *Staphylococcus aureus* and *Streptococcus pneumoniae* are used as bacterial model organisms to study the inflammatory response of different hosts (*Drosophila* flies, mice and rabbits) to these bacteria. Their objective is to better understand the bacterial cell wall metabolism, to determine the smallest component of the bacterial cell wall that can induce an innate immune response and its receptor in the eukaryotic cells, as well as find common, conserved, components of this immune response in the three host systems.

The laboratory of **Physiology of Lactic Acid Bacteria & in vivo NMR** (A. R. Neves) is a new group established in January 2004. The research interests in this team focus on the physiological and biochemical analysis of metabolic pathways and their regulation in the human pathogen *Streptococcus pneumoniae* and the model and closely related organism *Lactococcus lactis*. A major line of research for the next years is the study of the upper part of the glycolytic pathway, focusing mainly on carbohydrate transport and putative central carbon regulators, as well as the enzymes linking glycolysis with capsule production in *S. pneumoniae*. Molecular biology tools for the manipulation of LAB and several analytical techniques for the study of metabolism with emphasis on in vivo NMR studies of central carbon metabolism are commonly used in this lab.

Also recently established, the Laboratory of **Microbial Epidemiology** (R. Mato) studies the epidemiology of multi-antibiotic resistant enterococci at the hospital setting. The research in this team is centred around four main objectives: a) Evaluation of the prevalence of nosocomial infection and/or colonization by clinical relevant enterococcal species, particularly in high-risk groups such as newborns in neonatal intensive care units, and haematological malignancy patients; b) Application of typing methodologies to the characterization and identification of the clonal types circulating at the hospital setting; c) Detection of virulence genetic determinants associated with glycopeptide-resistant enterococcal strains (GRE); (d) Surveillance studies of GRE isolated from infection and carriage in high-risk patients, as well as the identification of the risk factors that contribute to the infection and colonization by GRE.

Highlights for the Laboratories of Sérgio Filipe, Ana Rute Neves and Rosario Mato are included in the section on the Laboratório Associado.

BIOLOGY DIVISION – STAFF.

Laboratory : Microbial Development (Intercellular signalling and cellular morphogenesis during *Bacillus subtilis* sporulation)

Head of Laboratory : Adriano O. Henriques

Research team :

Rita Zilhão	Ph.D.
Teresa Barbosa	Post-Doc
Mónica Paula Fernandes Serrano	Post-Doc
Gonçalo Bruno Rodrigues Carvalho	Ph.D.Student
Teresa Vasconcelos Costa	Ph.D Student
Luísa Côrte	Ph.D.Student
Cláudia Serra	Ph.D.Student
Joana Santos	Master Degree Student
Sérgio Pinto	Undergraduate Student
Filipe Vieira	Undergraduate Student

Laboratory : Physiology of Lactic Acid Bacteria and in vivo NMR

Head of Laboratory : Ana Rute Neves (see also Laboratório Associado Section)

Laboratory : Control of Gene Expression (mRNA degradation / ribonucleases transcription)

Head of Laboratory : Cecília Maria Arraiano

Research team :

Mónica Amblar Esteban	Post-Doc
Maria de Fátima Afonso Cairrão	Post-Doc
Patrick Oliveira Freire	Ph.D.Student
Sandra Cristina de Oliveira Viegas	Ph.D.Student
Ana Lúcia Mesquita Barbas *	Ph D student
José Eduardo Marques Andrade	Ph.D Student
Francisco Mesquita	Master student
Ana Rita Furtado	Master student
Marta Abrantes	Research Student
Ana Friães	Research Student

* in Biotecnol S.A. co-supervised with Dr. Andrew Kelly

Laboratory : Cell Physiology and NMR (Microbial Physiology/Biochemistry of Hyperthermophiles and Metabolic Engineering of Lactic Acid Bacteria)

Head of Laboratory : Helena Santos

Research team :

Clélia Neves Afonso	Post-Doc
Pedro Lamosa António	Post-Doc
Claudia Sanchez	Post-Doc
Maria Margarida Moreira dos Santos	Post-Doc
Nuno Miguel Formiga Borges	Post-Doc
Paulo Lemos*	Post-Doc
Tiago Quinhã Faria	Ph. D. Student
Luís Maria Lopes da Fonseca	Ph. D. Student

Maria Manuel Sampaio	Ph. D. Student
Luís Pedro Gafeira Gonçalves	Ph. D. Student
Filipa Maria Lage Dias Silva Cardoso	Ph. D. Student
Carla Alexandra Duarte Jorge	Ph. D. Student
Paula Cristina Lima Gaspar	Ph. D. Student
Melinda Carmen Noronha	Ph. D. Student
Tiago Moreira Pais	Graduate Student
Rute de Almeida Ferreira de Castro	Graduate Student
Marta Viseu Rodrigues	Graduate Student
João Cavalheiro	Graduate Student
Rui Neves	Graduate Student
Ana Isabel Mingote	Research Technician
Carla Patrícia Almeida	Research Technician

* co-supervision with FCT-UNL

Laboratory : Molecular Genetics (Antibiotic resistance/ infectious diseases)

Head of Laboratory : Hermínia de Lencastre

Research team :

Alexander Tomasz	Adjunct Full Professor (Invited)
Ana Madalena Ludovice	Ph.D.
Ana R. Gomes	Post-Doc
Duarte C. Oliveira	Post-Doc
Raquel Sá-Leão	Post-Doc
Marta Aires de Sousa	Post-Doc
Rita Sobral	Ph.D. Student
Susana Gardete	Ph.D. Student
M. Inês Crisóstomo	Ph.D. Student
Maria Miragaia	Ph.D. Student
Sandro Pereira	Ph.D. Student
Nuno Faria	Ph.D. Student (from Oct 04)
Sónia Nunes	Graduate Student
Natacha Sousa	Graduate Student
Carla Simas	Graduate Student
Nelson Frazão	Graduate Student
Teresa Conceição	Graduate Student (from Sept 2004)
Nuno Faria	Graduate Student
Teresa Crathorne	Graduate Student (from Sept 2004)
Catarina Milheiro	Graduate Student (from Nov 2004)
Teresa Figueiredo	Master Degree Student
Alexandra Simões	Master Degree Student

Maria Elena Meza (Jan-Fev 2004)	Visiting Scientist
Teresa Conceição (Junho 2004)	Visiting Scientist

Maria Cândida Lopes	Research Assistant
Isilda Gueifão	Laboratory Assistant
Manuela Nogueira	Administrative Assistant

Collaborators	
Ilda Santos Sanches, Ph.D.	Associate Professor FCT/UNL

Mario Ramirez, Ph.D.	Assistant Professor FM/UL
Isabel Couto, Ph.D.	Assistant Professor IHMT/UNL
António Brito-Avão, M.D.	Pediatrician
Joana Saldanha, M.D.	Pediatrician

Laboratory : Microbial Genetics (Metabolism and regulation of carbohydrate utilization in *Bacillus subtilis* / control of gene expression)

Head of Laboratory : Isabel Sá-Nogueira

Research team :

Irina Franco	Ph.D.Student
José Manuel Inácio	Ph.D.Student
Ana S. M. Antunes	Graduate Student (from Oct 2004)
Vanessa Barroso	Undergraduate student

Laboratory : Glycobiology (Intracellular transport / Protein Glycosylation)

Head of Laboratory : Júlia Costa

Research team :

Vanessa Morais	Ph.D.
Catarina Gomes	Graduate Student
Cristina Escrevente	Graduate Student
Eda Machado	Graduate Student
Ricardo Gouveia	Graduate Student

Laboratory : Microbial Epidemiology

Head of Laboratory : Rosário Mato Labajos (see also Laboratório Associado Section)

The Developmental Process of Sporulation in *Bacillus subtilis*.

Adriano Henriques : Microbial Development Laboratory.

The initiation of the developmental process of sporulation in the rod-shaped bacterium *Bacillus subtilis* requires phosphorylation of the Spo0A response regulator. Activated Spo0A-P then drives expression of the genes that govern the switch in the site of division septum formation from the mid-cell to a polar position. Spo0A-P also directs transcription of key sporulation loci, which are also negatively regulated by the Soj protein. The repressive action of Soj is counteracted by Spo0J, and both proteins belong to the Par family of chromosome partitioning proteins. Soj jumps from nucleoid to nucleoid via the cell pole. The dynamic behaviour of Soj is controlled by Spo0J, which prevents the static association of Soj with the nucleoid, and hence its transcriptional repression activity. Soj in turn is required for the proper condensation of Spo0J foci around the origin of chromosome replication region.

The asymmetric partitioning of the developing cell requires DivIB and other proteins involved in vegetative (medial) cell division (Fig.1A). DivIB forms a ring-like structure at the sites of medial or asymmetric cell division (Fig. 1B). We have found an allele of *divIB* (*divIB80*) that reduces the cellular levels of DivIB, and affects nucleoid structure and segregation, yet has no major impact on cell division. In *divIB80* cells Spo0J foci are not condensed and Soj associates statically with the nucleoid. The *divIB80* allele prevents Spo0A-dependent transcription and arrests sporulation prior to asymmetric division. The defect in Spo0A-dependent gene expression, and the Spo⁻ phenotype can be suppressed by *divIB* *in trans* or by deletion of the *soj-spo0J* locus. Since deletion of *spo0J-soj* does not restore the normal levels of DivIB, it follows that the low levels of DivIB in *divIB80* cells are sufficient for cell division, but not to sustain an earlier function of DivIB related to the activity of the Spo0J/Soj system of chromosome segregation. This suggests that DivIB acts in part to link proper chromosome segregation to asymmetric cell division at the onset of spore development. Our results also suggest that DivIB remains at the cell pole after the last round of vegetative division, and then re-localizes to the sites of asymmetric septum formation (2A). Our results further suggest that the re-localization of DivIB within the developing cell may occur via helical intermediates (Fig. 2B).

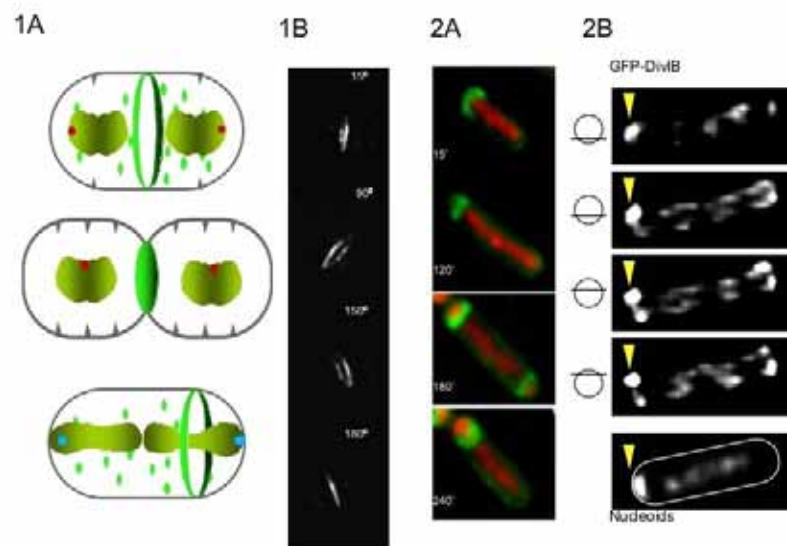

Regulated Gene Expression in *Lactococcus lactis*.

Cecília Arraiano : Control of Gene Expression Laboratory.

A maltose-inducible system was constructed for regulated gene expression in *Lactococcus lactis*. The system was established using Green Fluorescent Protein as a reporter. The transcription of a gene of interest from the inducible promoter of pLS1RGFP plasmid vector can be easily monitored by fluorescence spectroscopy and microscopy. Using this system the lactococcal ribonuclease III was overproduced in an active form and its expression was analyzed. Through complementation assays in *Escherichia coli* we demonstrated that the lactococcal RNase III (Lac-RNase III) is able to process rRNAs and mRNAs. Using a specific RNA substrate for this enzyme we standardized an enzymatic assay which allows the specific detection of the endonucleolytic activity of Lac-RNase III in *L. lactis* and *E. coli* crude extracts.

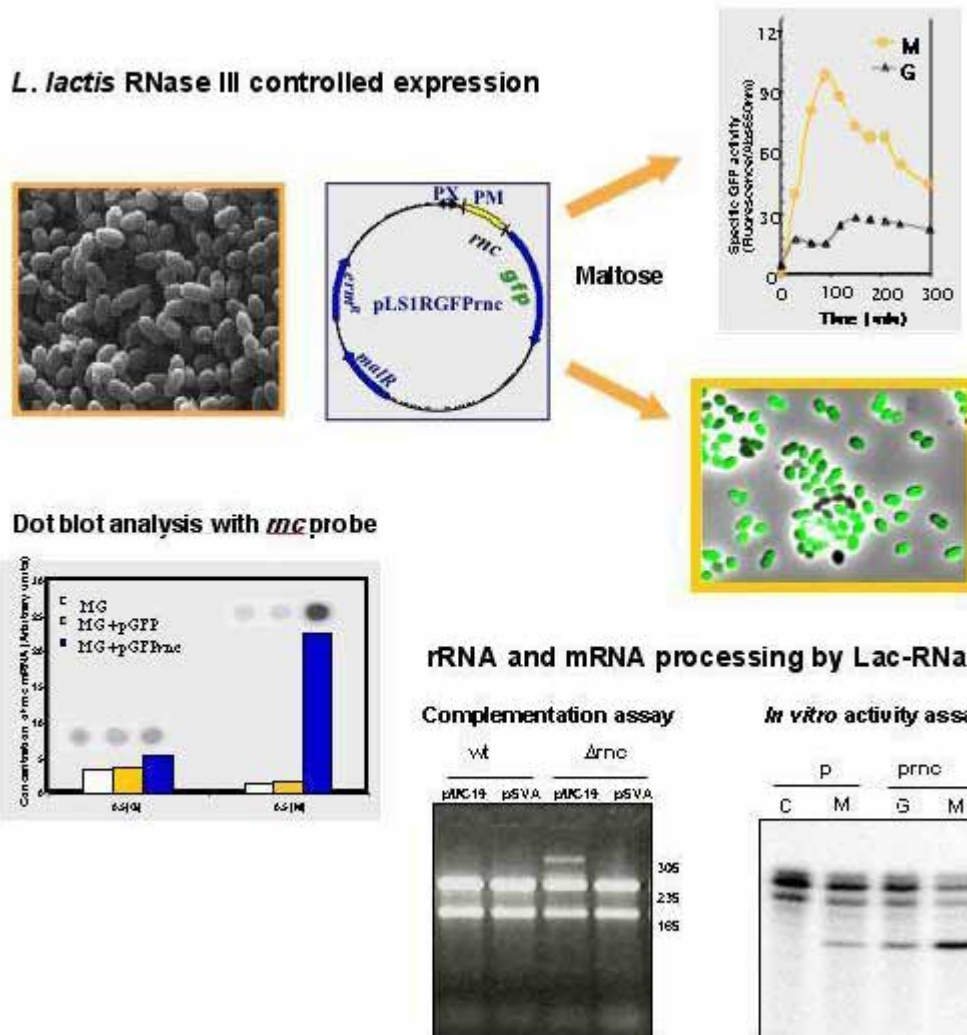

Engineering *Lactococcus lactis* for the Production of Nutraceuticals.

High Yields of Mannitol from Food-Grade Strains.

Helena Santos : Cell Physiology and NMR Laboratory.

Lactococcus lactis is a model organism in the study of Lactic Acid Bacteria. It has a simple metabolism in which glucose is converted to lactate with nearly 100% yield. In an attempt to redirect the carbon flux to the formation of products other than lactate, such as aromatic compounds, the gene encoding lactate dehydrogenase was disrupted leading to a strain severely restricted in its capacity to regenerate NAD^+ . Unexpectedly, this strain accumulated intracellularly high concentrations of mannitol-1-phosphate and produced mannitol. Therefore, the disruption of a single gene in *L. lactis* disclosed the unknown capacity of this organism to synthesize mannitol.

Metabolic engineering strategy

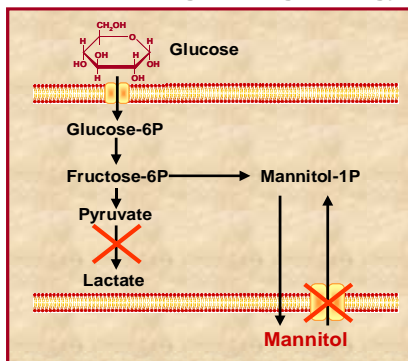

This is an interesting finding, since mannitol has been claimed to possess health-promoting properties; thus the enrichment of foods with mannitol by *in-situ* production during fermentation could be a positive, clean strategy to obtain healthier fermented food products. The observation of mannitol production by LDH-deficient strains fostered further metabolic engineering strategies directed to improve the yield of mannitol production. We observed that mannitol produced was taken up and rapidly metabolised after glucose depletion. Therefore, it was apparent that the design of a mannitol-producing strain would have to consider the ability of *L. lactis* to utilize mannitol as carbon source. Thus, the disruption of the mannitol transport system in *L. lactis* was envisaged in the metabolic strategy pursued in our team (see Figure). A food-grade LDH-deficient strain was used as genetic basis for knocking-out the genes *mtlA* or *mtlF*, encoding components of the mannitol transport system. Non-growing cells of a double mutant with deletions of *ldh* and *mtlA* yielded mannitol, ethanol, 2,3-butanediol, and lactate as major end products, with approximately one-third of the carbon from glucose being channelled to the production of mannitol. Using a simple metabolic engineering strategy we constructed a food-grade strain of *L. lactis* that can be used for the *in-situ* production of mannitol in dairy fermented products.

Mannitol, a major product of glucose metabolism in a mutant of *Lactococcus lactis* deficient in lactate dehydrogenase and a component of the mannitol transport system

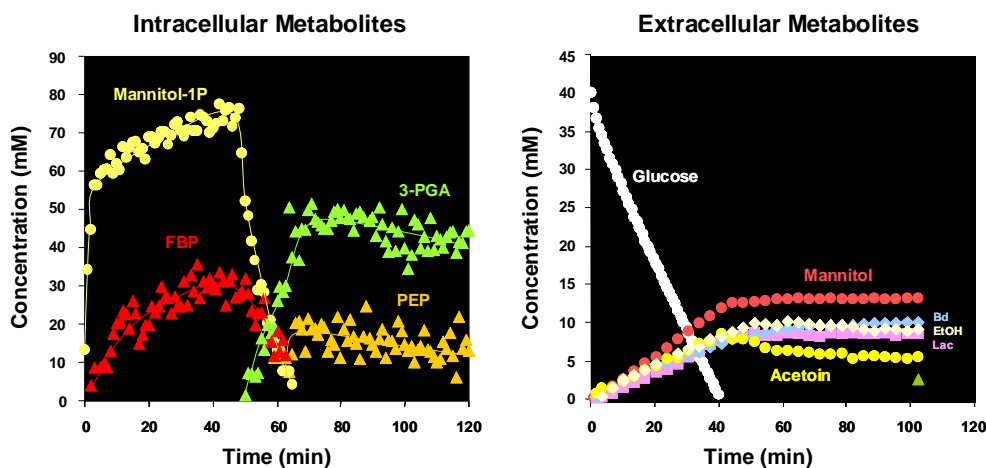

Role of *murE* in the Expression of β -Lactam Antibiotic Resistance in *Staphylococcus aureus*.

Herminia de Lencastre : Molecular Genetics Laboratory.

It was shown earlier (Ludovice A.M et al. 1998. Microb. Drug Resist. 4:85-90) that *Tn551* inserted into the C-terminal sequence region of the *murE* gene of the parental methicillin resistant *Staphylococcus aureus*, (MRSA) strain COL, causes drastic reduction in methicillin resistance, accompanied by accumulation of UDP-MurNAC-dipeptide in the cell wall precursor pool and incorporation of these abnormal muropeptides into the peptidoglycan of the mutant. Methicillin resistance was recovered in a suppressor mutant. In order to test the impact of inhibition of MurE on β -lactam resistance, we put the transcription of the gene under the control of the IPTG inducible promoter Pspac. Bacteria grown in the presence of sub-optimal concentrations of IPTG accumulated UDP-MurNAC-dipeptide in the cell wall precursor pool. Both growth rates and methicillin resistance levels, but not resistance to other antibiotics, were a function of IPTG concentration. Northern analysis showed a gradual increase in the transcription of *murE* and also in the transcription of *pbpB* and *mecA*, parallel with the increasing concentrations of IPTG in the medium. A similar increase in the transcription of *pbpB* and *mecA*, the structural genes of penicillin binding proteins (PBPs) 2 and 2A, was also detected in the suppressor mutant. The expression of these two proteins that are known to play critical roles in the mechanism of staphylococcal methicillin resistance, appears to be – directly or indirectly – under the control of the *murE* gene. Our data suggest that the drastic reduction of the methicillin MIC value in the *murE* mutant may be caused by the insufficient cellular amounts of these two penicillin binding proteins.

S. Gardete, A. M. Ludovice, R. G. Sobral, S. R. Filipe, H. de Lencastre, and A. Tomasz. *Journal of Bacteriology*. 2004. 186: 1705-1713.

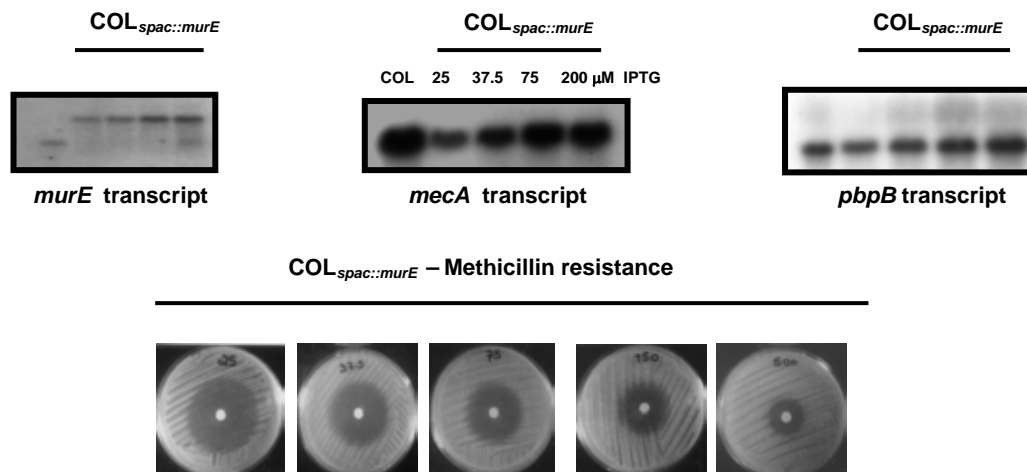

(adapted from S. Gardete et al. 2004. J. Bacteriol. 186:1705-1713)

The Role of Glycotransferases in the Cell Secretory Pathway.

Júlia Costa : Glycobiology Laboratory.

Glycosyltransferases (GTs) catalyze the transfer of a monosaccharide residue from the nucleotide sugar donor to newly synthesized glycoproteins, glycolipids or other glycoconjugates. α 3/4 Fucosyltransferase III (FT3) catalyzes the transfer of Fuc from the GDP-Fuc donor onto several acceptors, thus synthesizing the carbohydrate Lewis determinants which are involved in cell adhesion.

In the secretory pathway, GTs are distributed from the endoplasmic reticulum (ER), along the Golgi apparatus (GA) to the *trans*-Golgi Network (TGN). The concerted and sequential action of GTs results in the synthesis of the oligosaccharides naturally occurring on glycoconjugates. The mechanisms underlying the localization of GTs to the GA are not fully understood at present, since a common localization motif has not been found at their primary structure level.

Work from previous years showed that more polar and Cys residues from the transmembrane domain of FT3 are required for its localization in the Golgi. This year, we showed that the cytoplasmic domain of FT3 is required for its subcompartment localization in the Golgi. Furthermore, we have found that a fraction of Golgi FT3 was contained in detergent resistant membranes (DRMs). These results have contributed to the understanding of the molecular basis of the localization of GTs in the Golgi.

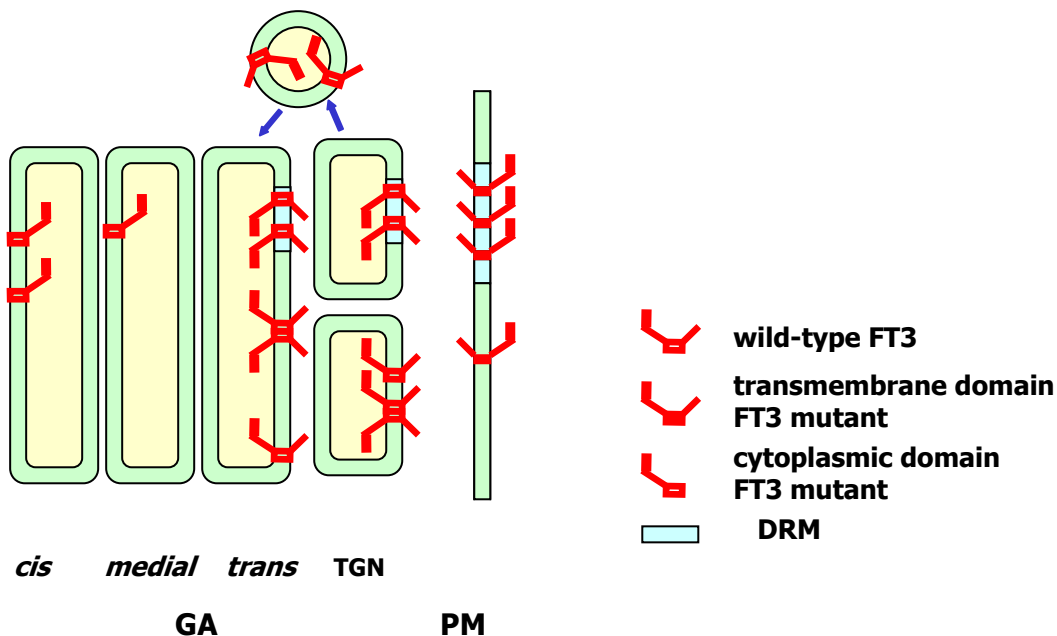

Model for the regulation of the steady-state localization of FT3 in the Golgi of mammalian cells.



BIOLOGICAL CHEMISTRY

BIOLOGICAL CHEMISTRY DIVISION: Objectives and Activities.

The research focus of the Biological Chemistry Division is to explore the structure and function of proteins by an integrated approach involving biophysical, biochemical, cell and molecular biological methodologies bringing together several groups of researchers with adequate and complementary expertises in these areas.

Our activities broadly cover the following areas; a) Sulphate and oxygen respiration, b) NO metabolism and signalling, c) Oxidative, metals and metalloid stresses, d) Protein Structure, folding and stability, e) Protein Modelling, and f) Proteins in Biotechnology.

ITQB and in particular our Division started by studying metalloproteins and their function in several biological processes using different bacteria as models. The anaerobic bacterium *Desulfovibrio gigas* has been the most extensively studied. *Desulfovibrio* sp possess several metallo-enzymes which are important in health as transporters of metals and oxygen, in agriculture as important players in the fixation of nitrogen as well as their involvement in denitrification, and in economic terms due to their properties related to biocorrosion. Many novel metalloenzymes were first discovered in sulfate reducing bacteria, which were afterwards proven to be widespread in the microbial world. At present, these studies encompass many other prokaryotes, such as bacteria involved in bioremediation, thermophilic bacteria and archaea, enterobacteria and other bacterial pathogens.

The importance of metals, as essential atoms in the activity of proteins, has been amply recognized. The studies of the founder of ITQB, Professor Antonio Xavier, together with his students and collaborators, have much contributed to the understanding of their function. The transition metal ions (e.g. V, Mn, Fe, Co, Ni, Cu, Mo) have important properties as they are available in more than one stable oxidation state and have a versatile coordination chemistry. The latter allows them to bind an enormous variety of substrates, cofactors and amino acids (including the peptide amide groups). They catalyse reactions involving charge transfer processes, act as simple electron carriers in electron transfer chains, and are part of transport proteins due to their affinity to small ligands such as O₂, CO or NO. Therefore, such fundamental processes as the splitting of the water molecule in photosynthesis, the reduction of oxygen (or of other inorganic respiratory substrates as nitrate or nitrite) in respiration, the fixation of N₂ as ammonia, the biosynthesis of nucleic and amino acids, the transport of oxygen in the blood, the sensing of external stimuli such as oxygen levels, or the degradation of many organic compounds, are performed by transition-metal containing enzymes. The plethora of processes involving metalloproteins is only made possible through a combined effect of the intrinsic metal ion properties and the protein environment where it resides. In fact, metals and metallic centres play an important role in the stability and folding of a protein, and this aspect is also under study within the Division. Metal centres act as local structural stabilising elements in the folded state,

contributing to the maintenance of a given specific structural fold, and are potential key nucleation points during *in vivo* folding.

However, if on the one hand there is the requirement for metals in the aforementioned processes, on the other hand the excess of metals generates toxic effects and as a consequence cells have developed many potent mechanisms to decrease their toxicity. Thus, gene expression is reprogrammed through the activation of a myriad of transcription factors resulting in the synthesis of new proteins such as molecular chaperones, responsible for maintaining protein folding, as well as a diverse network of players including membrane transporters and proteins involved in repair, nutrient metabolism, osmolyte production, among others. Metal accumulation also results in disease, as is the case of the neurodegenerative disorder Friedreich's ataxia, which involves frataxin, a small protein involved in iron metabolism. These patients have either poor frataxin levels, as a result of triplet expansion within the frataxin gene, or express misfolded frataxin as a result of specific point mutations. Correlating the effects of particular mutations on frataxin structure and folding, with different phenotypes of disease expression is a challenging task, and research in this area is being pursued within the division.

However, not only do metals and metalloids exhibit toxicity but also several are reactive oxygen species (ROS) and ROS-generator agents. These species, formed during normal metabolism (mitochondrial respiratory chain, during fatty acid metabolism), represent different oxidation states of O_2 and include the superoxide anion, O_2^- , H_2O_2 and the highly reactive OH^\bullet radical that can react with almost all cellular compounds. Survival and growth resumption imply successful cellular adaptation to the new conditions as well as the repair of damage incurred to the cell. We are therefore studying events related with several forms of stress either at upstream or downstream levels.

Another research line is related with NO metabolism. Indeed, nitric oxide is not only an obligatory intermediate in denitrification, but also a signalling and defence molecule of major importance. However, the basis of resistance to NO and RNS (reactive nitrogen species) is poorly understood in many microbes. The cellular targets of NO and RNS (e.g. metalloproteins, thiols in proteins, and glutathione) may themselves serve as signal transducers, sensing NO and RNS, and resulting in altered gene expression and synthesis of protective enzymes. The properties of a number of such protective mechanisms include flavorubredoxin, diverse enzymes with NO- or S-nitrosothiol-reducing properties and other redox proteins with poorly defined roles in protection from nitrosative stresses.

Global approaches, integrating biophysics, bacterial molecular genetics, physiology combined with post-genomic technologies (e.g. transcription profiling), are being used in order to advance our understanding of protein function not only in mechanisms involved in NO tolerance as well as those involved in adaptation to different environmental conditions. Iron metabolism is intimately related with ROS and RNS stresses and thus, it is also being studied in anaerobic bacteria.

One of the most fundamental processes in life is energy transduction. The molecular mechanisms of this process have been extensively studied either using small metalloproteins (multiheme cytochromes) as model systems, or bacterial respiratory chains from thermophilic organisms. These studies are aimed at establishing the molecular basis of coupling between electron transfer and proton translocation and of the biochemical and structural characterization of complex membrane-bound metalloenzymes involved in respiratory processes.

Many metalloenzymes have important biotechnological applications, which are being addressed in particular with bacterial laccases. These enzymes are multicopper oxidases capable of coupling the oxidation of a variety of phenolic substrates with the concomitant reduction of oxygen to water. The elucidation of some structural and functional aspects of laccases governing the mechanism of electron transfer and oxygen reduction, the redox potential and the pH activity profile are expected to have an important and helpful impact in the more applied area of enzyme technology. A research program is being carried out that aims at designing optimised laccases for biotechnological applications by protein engineering techniques.

X-ray Crystallographic studies have extended in the last years from metalloproteins to other proteins, such as those involved in the degradation of mRNA, in bone formation and maturation, from the innate immune system (in collaboration with IGC) or proteins involved in host-pathogen interactions from the pathogenic bacteria *Campylobacter jejuni* and *Klebsiella pneumoniae*. Collaborations with pharmaceutical companies have been fostered through IBET to the study of other medically important proteins, involving Schering AG Berlin and the Portuguese pharmaceutical company, BIAL. Furthermore, structural characterisation on several membrane proteins has also recently started, aiming at a better understanding of the mechanisms involved in electron transfer and catalytic reactions.

Theoretical methods are being used and developed to elucidate problems in protein function. In the field of redox proteins, investigations led to the elucidation of proton-transfer mechanisms in non-canonical haem-copper oxidases (*R. marinus caa₃*), and the comparison with canonical ones. Water molecule chains, potentially important in the proton transfer mechanism were investigated in the haem-copper oxidase Quinol Oxidase *aa₃* from *A. ambivalens*. The interaction between

proteins was also an object of research, namely between the type I and type II cytochromes c_3 from *D.vulgaris*, where we found significant changes in the thermodynamics of electron transfer upon complex formation. Similar results have been found with the interaction of redox proteins and SAMs. Work in the field of catalysis in non-aqueous solvents, allowed the prediction of enantioselective properties of cutinase in hexane and to elucidate the molecular reasons for this behavior. Several protein structures have been elucidated by comparative modeling methods. Work in the field of constant pH molecular dynamics simulation is going on, with new methods being developed and applied to small peptides and model proteins.

In summary, the Biological Chemistry Division research encompasses a wide range of important biological subjects, involving a trans-disciplinary and global approach, from molecular genetics to sophisticated spectroscopic methods (Resonance Raman, NMR and EPR), computational methods and X-ray crystallography.

Highlights from the Laboratories of Ricardo Louro, António Baptista, Margarida Archer and Cláudio Gomes are included in the section on the Laboratório Associado.

BIOLOGICAL CHEMISTRY DIVISION – STAFF.

Laboratory: Structure and Function of Metalloproteins (Metalloproteins, Bioenergetics; Molecular Genetics; NMR; Sulfate Reducing Bacteria)

Head of Laboratory : António V. Xavier

Research Team :

António Bernardo Pinho de Aguiar	Ph.D.
David L. Turner	Visiting Professor
Teresa Catarino	Ph.D.
Miguel Pessanha	Ph.D. Student
Vitor Manuel	Ph.D. Student
Catarina Paquete	Ph.D. Student
Patricia Pereira**	Ph.D. Student
Ricardo Pires*	Ph.D. Student
Ricardo Lopes	Undergraduate Student
Paulo Joaquim	Undergraduate Student
Isabel Pacheco	Technician

* PhD in co-supervision with Inês Cardoso Pereira

** PhD in co-supervision with Inês Cardoso Pereira and Ricardo O. Louro

Laboratory : Molecular Simulation

Head of Laboratory : António M. Baptista (see also Laboratório Associado Section)

Research team :

Miguel Machuqueiro	Post-Doc
Vitor H. Teixeira*	Ph.D. Student
Sara Campos	Graduate Student

*co-supervised Cláudio Soares

Laboratory : Genomics and Stress (Gene Expression and Stress)

Head of Laboratory : Claudina Rodrigues-Pousada

Research team :

Isabel Solange Oliveira	Ph.D./Collaborator
Paulo Guerreiro	Ph.D./Collaborator
Regina Menezes	Post-Doc
Dulce Alexandra Azevedo	Ph.D. Student
Maria Manuela Parreira Broco	Ph.D. Student
Tracy Nevitt	Ph.D. Student
Rute Rodrigues	Ph.D Student
Jorge Pereira	Ph.D Student
Catarina Amaral	Ph.D Student
Catarina Pimentel	Ph.D Student
Patricia Machado	Graduate Student
Rute Felix	Graduate Student
Ana Alberto	Undergraduate Student

Laboratory : Protein Biochemistry, Folding and Stability

Head of Laboratory : Cláudio M. Gomes (also see Laboratório Associado Section)

Research Team :

Sónia Leal	Ph.D. Student
Bárbara Henriques	Graduate Student
Ana Raquel Correia	Undergraduate Student
Rita Rocha	Undergraduate Student
Joana Leitão	Undergraduate Student
Ana Leonor Casaca	Undergraduate Student

Laboratory : Protein Modeling (Molecular Mechanisms / Redox proteins)

Head of Laboratory : Cláudio M. Soares

Research Team :

Paulo J. Martel	Ph.D.
Carlos A. Cunha	Post-Doc
Vitor H. Teixeira*	Ph.D. Student
Bruno L. Victor	Ph.D. Student
Nuno M. Micaelo	Ph.D. Student
Ana Sofia Oliveira	Graduate Student

*co-supervised António Baptista

Laboratory : Microbial Biochemistry (Sulfate Reducing Bacteria / Anaerobic respiration)

Head of Laboratory : Inês A. Cardoso Pereira

Research Team :

Ana Filipa Valente	Ph.D. Student
Cláudia Lomba Fernandes	Graduate Student
Sofia Venceslau	Undergraduate Student
Inês Carvalho Martins	Undergraduate Student

Laboratory : Molecular Genetics of Metalloproteins

Head of Laboratory : Lígia Saraiva Teixeira

Research Team :

Marta C. Justino	Ph.D. Student
Cláudia Almeida	Graduate Student
Susana Lobo	Ph.D. Student
Vera Gonçalves	Undergraduate Student
Lígia Nobre	Undergraduate Student

Laboratory : Inorganic Biochemistry and NMR

Head of Laboratory : Ricardo O. Louro (see also Laboratório Associado Section)

Research Team :

Carlos A. Salgueiro	Ph.D.
Patricia Pereira*	Ph.D. Student

* Ph.D. in co-supervision with Inês Cardoso Pereira and Ricardo O. Louro

Laboratory : Macromolecular Crystallography
Head of Laboratory : Maria Arménia Carrondo

Macromolecules with Industrial and Medical Applications Group.

Group Leader : Pedro Matias

Susana Gonçalves	Graduate Student
Gonçalo Gato Lopes	Undergraduate Student

Crystallographic Structure-Function Group.

Group Leader : Carlos Frazão

David Aragão	Ph.D. Student
Tim Urich**	Ph.D. Student
Joana Raquel Rocha	Graduate Student

Host-pathogen Interactions Group.

Group Leader : Francisco Enguita*

Ana Maria Gonçalves	Post-Doc
David Marçal	Ph.D. Student
Sofia Caria	Undergraduate Student
Ana Rêgo	Research student
Mário Correia	Ph.D. Student

Membrane Proteins Group.

Group Leader: Margarida Archer – also see Laboratório Associado Section.

Luisa Rodrigues	Ph.D. Student
Diana Plácido	Ph.D. Student
José Brito	Graduate Student
Tânia Oliveira	Undergraduate Student

Other members.

Peter Crowley***	Post Doc
Colin McVey	Post-Doc
Isabel Bento	Post-Doc
Ricardo Coelho	Technician
Daniele di Sanctis**	Ph.D. Student

* SPINE Research Assistant (Structural Proteomics in Europe)

** EDS-SB Marie Curie Ph.D. student (in collaboration with Univ. Darmstadt)

*** Marie Curie post-doctoral fellow

Laboratory : Microbial and Enzyme Technology

Head of Laboratory : Lúgia Oliveira Martins

Research Team :

Carlos Pinheiro	Graduate Student
André Fernandes	Undergraduate Student

Laboratory : Metalloproteins and Bioenergetics (Membrane- and metallo- proteins / aerobic respiration/ oxygen detoxification/ iron metabolism/ EPR)

Head of Laboratory : Miguel Teixeira

Research Team :

Ana Margarida Carvalho Melo	Post-Doc
Manuela Alexandra Marques Pereira	Post-Doc
Andreia de Sousa Fernandes	Post-Doc
João Filipe Bogalho Vicente	Ph.D.Student
João Vieira Rodrigues	Ph.D. Student
Maria Filipa de Lima de Sousa	Ph.D. Student
Fabian Muller	Ph.D. Student
Maxime Cuypers	Ph.D. Student
Joana Marques	Undergraduate Student
Ana P. Baptista	Undergraduate Student
Ana P. Refojo	Undergraduate Student
Magda Teles	Undergraduate Student

Novel Mechanisms for Energy Transducers: Haemproteins.

António Xavier : Structure and Function of Metallo-proteins Laboratory.

Cooperative effects are fundamental for electroprotonic energy transduction processes. However, the primary cooperative mechanism used by transmembrane proteins to perform these processes is still a matter of great controversy. To understand cooperative processes fully, it is necessary to obtain the microscopic thermodynamic parameters for the functional centres and relate them to the relevant structural features. Mechanisms used by simpler proteins operative in similar processes include negative e^-/H^+ cooperativities (redox-Bohr effect, rB^-). This capacity is used to propose a novel mechanism for cytochrome *c* oxidase (CcO).

Several examples of the molecular and structural bases that control the mechanisms of functional cooperativities are known. Remarkably, most of these proteins are either metallo- or metal activated-proteins. Here, the paradigm is the historic work on haemoglobin, Hb, a protein that presents a complex network of cooperativities. The molecular basis for the cooperativity effects of haemoglobin involves an equilibrium between two structures: the tense, T (with low affinity for oxygen and high affinity for protons) and the relaxed, R (with reversed affinities).

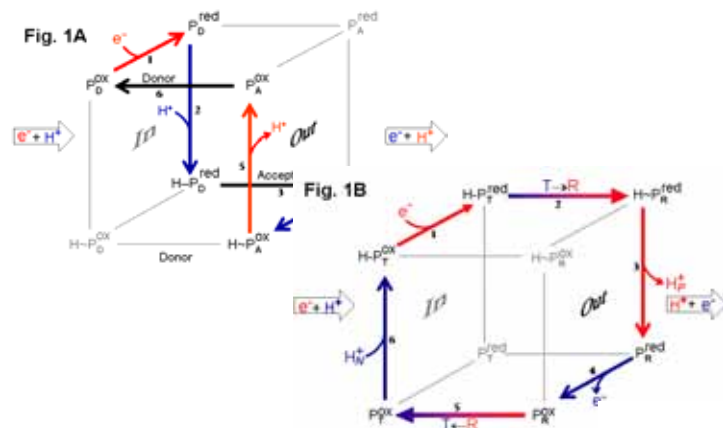
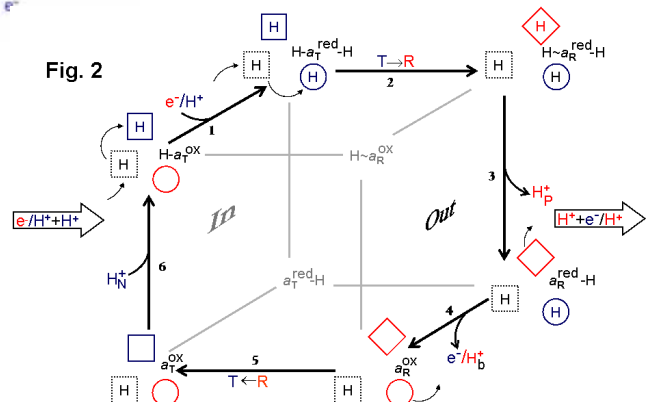

Fig. 1- Redox-Bohr mechanisms. A- The rB^+ mechanism starts with the stable deprotonated oxidised state of the transducing protein, P, bound to the reduced/protonated donor (D). After coordinated transfer of electron(s) and proton(s) (steps 1 and 2), the donor leaves, and the common intermediate is ready to bind the acceptor (A) and receive these particles (steps 4 and 5). In this mechanism, the common intermediate state ($H-P^{red}$) is basic keeping the proton until it binds to a specific acceptor to receive the electron from a higher E_m centre. Only then is the rB^+ group acidified. The basis for vectoriality is the state-specific stepwise recognition of the donor/acceptor proteins (steps 3/6). B- In the negative effect, rB^- , the stable high pK_a^{ox} oxidised state is already protonated. After reduction (step 1), there is a conformational change (step 2) to a higher energy structure ($T \rightarrow R$) and the H^+ is immediately ready to be pumped (step 3). Electron transfer to a centre with higher E_m is linked to the ($R \rightarrow T$) structural change and the basified rB^- group can again recruit a proton (step 6).

Fig. 2 – Medial model for the proton activation mechanism coupled to the redox-cycle of haem *a* in CcO. Three protic centres are shown in the cubane scheme of this model. The solid line square/diamonds represent the rB_1^+ group and the circles represent the rB_2^- groups (dotted squares represent proton antennas, ready to feed the rB_1^+ groups). The functional cycle starts with its stable oxidised protonated state (high pK_a^{ox}), which is then acidified by the redox-linked conformational change (steps 1 and 2). Deprotonation of the activated (lower pK_a) group of this intermediate state is followed by the synchronous reoxidation/deprotonation of rB_1^+ , and the conformational change back to the T state (steps 4 and 5). The rB_2^- group, again with a basic pK_a , can recruit another proton from the N-side (step 6).



Soluble cytochromes can perform electrogenic proton activation using anti-electrostatic mechanisms to control the movement of charges, eliciting both positive e^-/e^- , as well as negative e^-/H^+ (rB^- , Fig. 1A) cooperativities [1], which can explain the functional and the thermodynamic data of CcO using a mechanistic model based on the participation of two protonic groups, of opposite signs and different functions, coupled to the redox states of haem *a*. In contrast with current models, the rB^- effect implies a T/R conformational switch that controls a molecular ratchet, enforcing a vectorial mechanism for the localised pumping of protons upon reduction of the haem *a*, which can stimulate ATP synthesis [2]. The rB^+ (Fig. 1B) group can control the relative thermodynamics of the redox potentials of haem *a* and a_3 , ensuring the efficacy of electron/proton transfer to the binuclear centre (Fig. 2) [3].

1. IJ Correia *et al.* (2004) *J. Biol. Chem.* **279**, 52227-52237, and references therein
2. AV Xavier (2002) *FEBS Lett.* **532**, 261-2663.
3. AV Xavier (2004) *Biochim. Biophys. Acta-Bioenergetics* **1658**, 23-30

Gene Expression under Stress Conditions using Yeast as a Biological Model.

Claudina Pousada : Genomics and Stress Laboratory.

Saccharomyces cerevisiae responds to several environmental insults by triggering different mechanisms in which the family of b-Zip proteins, Yeast activator Proteins (Yaps), is involved. This family has been studied for several years aiming to understand the function of its members. During the last year, we like to highlight the recent data obtained with respect to Yap2. It was shown that when induced upon exposure to cadmium stress, Yap2 re-localises to the nucleus through a Crm1-dependent mechanism, where it activates the transcription of its target gene *FRM2*, encoding a protein homologous to nitroreductase. The precise role of this protein in metal stress response remains unclear. The C-terminus of the Yap1 and Yap2 proteins is sufficient to distinguish between the stress imposed by Cd^{++} and H_2O_2 . Indeed, domain swapping of Yap1 c-CRD by that of Yap2 has shown that the fusion protein is regulated by cadmium but not by H_2O_2 . Nuclear localisation of the fusion protein correlates with both activation of *FRM2* transcription but also with growth in increasing concentrations of cadmium but not of H_2O_2 . Although Yap1 is required for cadmium stress, it seems that Yap2 is intervening through a different mechanism. Our data also indicate that Yap2 and Yap8 bind directly to cadmium and arsenic compounds, respectively in a manner similar to Yap1 when activated by thiol-reactive chemicals (see Figure). As Yap8, Yap1 is as well activated through the metalloids 2highlighting the relevance of multiple mechanisms of arsenic management.

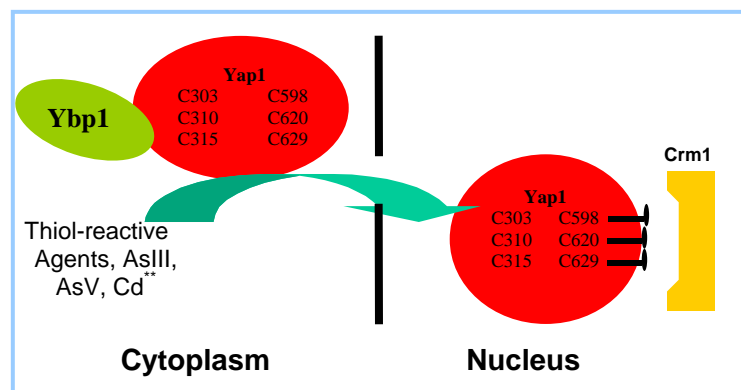

Under thiol-reactive agents, and possibly the metalloids and metals, a second redox centre operates involving the Cys598, Cys620 and Cys629 of Yap1, Yap8 and Yap2, to which the drugs bind directly.

(Rodrigues-Pousada *et al*, FEBS Letters, 567, 80-85)

Proton Channels in Oxygen Reductases using Theoretical Methodologies.

Cláudio Soares : Protein Modeling Laboratory.

Haem-copper oxidases are the terminal oxidases of aerobic respiratory chains found both in eukaryotes and prokaryotes. These proteins are able to reduce oxygen to water, and at the same time pump protons across the mitochondrial or periplasmic membranes, generating a proton gradient used in the production of ATP.



Water Probability Density Function (WPDF) represented as a red contour

Given that the catalytic activity of these proteins occurs well inside the subunits I (at haem cofactors), proton channels must exist in order to allow the protons to reach the catalytic centre, for reaction with oxygen, and to be translocated from one side of the membrane to the other. Several different channels have been previously identified using site-directed mutagenesis and structural data. However, due to the high divergence among the haem-copper oxidase superfamily, these proton channels can show remarkable differences and their conservation is a matter of debate.

in haem-copper oxidases. In order to structurally understand the proton translocation mechanism we have combined comparative modeling techniques with a statistical analysis of the distribution of water molecules in the protein matrix (WPDF).

The Quinol Oxidase from *Acidianus ambivalens* is an example of a protein whose proton-channel topology departs from that most commonly found

The combination of these methods allowed us to propose a three dimensional model of this protein, where we were able to propose three different proton channels through which the proton pumping mechanism may occur. These channels were named as D, K, and Q-spatial homologous channels due to their spatial similarity with D, K and Q-channels respectively found in the canonical haem-copper oxidases, such as the *P. denitrificans* oxidase. Our results show that this new approach can be very useful to study systems where water molecules are important to their biological function.

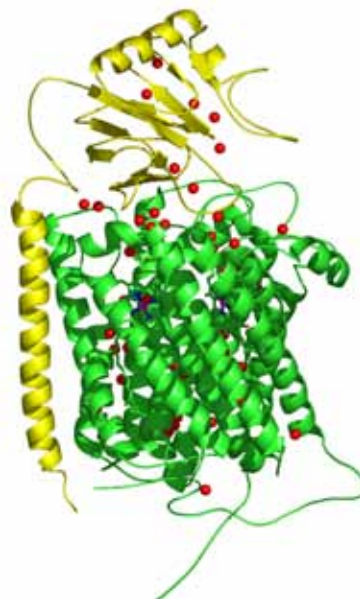

Final model of the Quinol Oxidase aa₃ from *Acidianus ambivalens*

Reference: Victor, BL, Baptista, AM, Soares, CM, (2004) "Theoretical identification of proton channels in the quinol oxidase aa₃ from *Acidianus ambivalens*" *Biophys J.*, **87**, 4316-4325

A Study of Intestinal Sulfide-producing Bacteria in Children and their Relationship to Inflammatory Bowel Diseases.

Inês Cardoso Pereira : Microbial Biochemistry Laboratory.

Human intestinal flora has a critical role in health, with important metabolic, developmental and protective functions. There is mounting evidence that the establishment of intestinal flora during the early years is critical for development of a balanced immune system. Inflammatory bowel diseases (IBD) are characterised by a chronic inflammation in the gastrointestinal tract generated as a consequence of a dysregulated immune response to environmental factors, in particular the ubiquitous luminal antigens originating from commensal bacteria. It is still not clear whether this aberrant response is induced by specific microorganisms and/or whether it results from an imbalance between pro-inflammatory versus protective intestinal bacteria. Among the proposed pro-inflammatory bacteria are those that produce hydrogen sulfide, a very toxic compound to colonic epithelial cells.

We have been involved in the study of anaerobic sulfide-producing bacteria (SPB), mostly sulfate reducers, isolated both from the environment and the human large gut. Our Laboratory and that of the Molecular Genetics of Metalloproteins are now conducting a study in collaboration with the Paediatric Service of the Hospital de Santa Maria to investigate by a molecular method, the prevalence of specific species of sulfide-producing bacteria in stool samples of healthy children and children with IBD. Work carried out so far has concentrated on samples from healthy children, and has revealed that there are age-related differences in the colonisation of the intestine by several species of SPB, one of which is an opportunistic pathogen. This is an interesting result that may have some correlation to the diet and the widespread use of sulfur-based compounds as food additives.

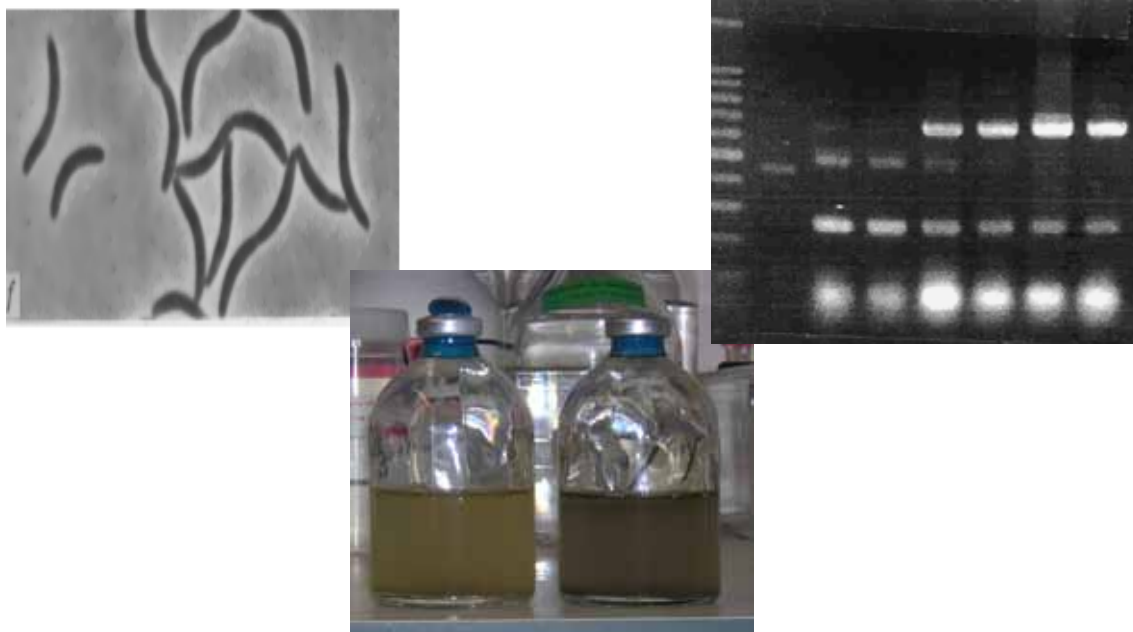

Figure : From the left are shown cells of SPBs, flasks with anaerobic cultures, and a electrophoresis gel used for species identification.

Transcriptome of *Escherichia coli* under Nitrosative Stress Conditions.

Lígia M. Saraiva : Molecular Genetics of Metalloproteins Laboratory.

Phagocytes (e.g. macrophages) employ diverse antimicrobial mechanisms to destroy invading pathogens, including the production of nitric oxide (NO). To unravel the mechanisms by which bacteria withstand this stress, we used DNA microarrays to assess global gene transcription profile of *Escherichia coli* exposed to nitric oxide whilst growing anaerobically, a favourable condition for pathogen colonisation. We found that NO modifies (~4% of the entire genome) the transcription of genes encoding for proteins involved in a wide range of cell functions. Multiple strategies for bacterial survival are triggered, through the induction of several enzymatic systems that include detoxification enzymes, iron-sulphur cluster assembly systems, DNA repairing enzymes, stress response regulators and possible induction of virulence associate factors. We have also discovered two new *Escherichia coli* genes able to confer resistance to nitric oxide, namely the gene product of YtfE and a potential transcriptional regulator of the helix-turn-helix LysR-type (YidZ).

Justino M.C., Vicente J.B., Teixeira M., Saraiva L.M. (2005) J. Biol. Chem., 280, 2636.

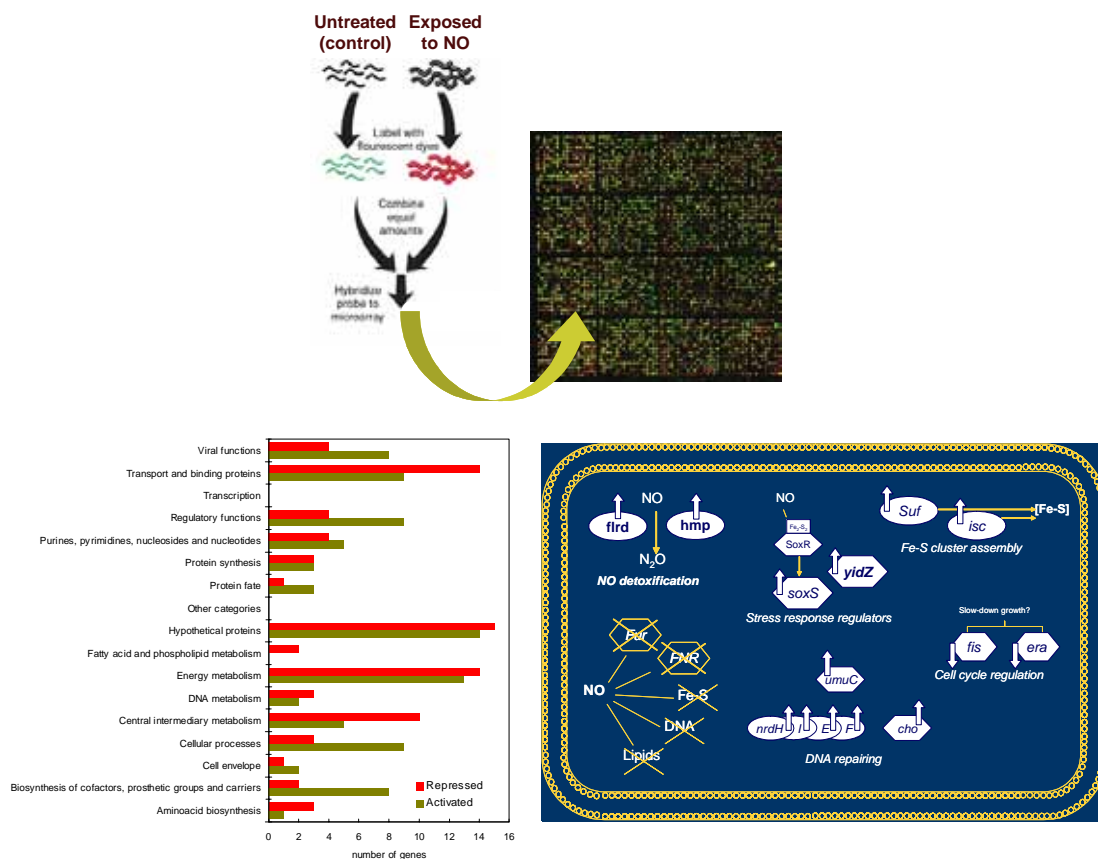

Structural Determination of Sulphur Oxygenase Reductase (SOR) from *Acidianus ambivalens*.

**Maria Arménia Carrondo : Macromolecular Crystallography Laboratory &
Carlos Frazão : Crystallographic structure-functions Group.**

The biological oxidation of elemental sulphur and of reduced inorganic sulphur compounds to sulphate is one of the major reactions in the global sulphur cycle, and is restricted to the prokaryote domains of life. It is also a key reaction in biotechnological processes such as the biomining of low-grade metal ores. Contrasting its significance, relatively little information is available about the enzyme systems involved in sulphur oxidation, and to date no atomic structure of one of these enzymes has been available.

A large number of thermophilic organisms populate solfataras and hot springs of volcanic origin, among which the chemolithotrophic species constitute the basis of the food chains. *Acidianus ambivalens*, a thermoacidophilic and chemolithoautotrophic crenarchaeote, has developed into a model organism for these sulphur dependent thermophiles. The initial step in its aerobic energy metabolism is performed by the sulphur oxygenase reductase (SOR). This cytoplasmic enzyme catalyzes the coupled oxidation and reduction of elemental sulphur to sulphite, thiosulphate and sulphide only in the presence of oxygen. As no external electron donor is needed for the reaction, sulphur must be both the electron donor and acceptor of the reaction. As a cofactor essential for catalysis, a mononuclear non-heme iron centre per subunit is used. The 3D structure determination shows that the SOR is a huge oligomeric complex of 870 kDa composed of 24 identical monomers having an alpha-beta fold. The highly symmetrical SOR particle encloses a central hollow compartment where the complex sulphur oxidation and disproportionation reaction takes place.

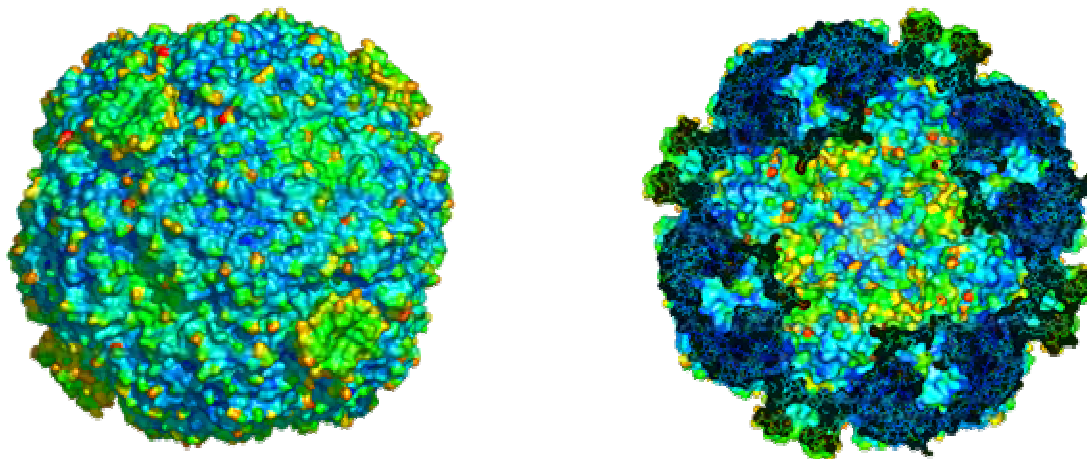

Legend: Two views of the SOR particle represented by its molecular surface coloured according to its atomic temperature factors, ranging from lower (blue) to higher (red) atomic vibrating sites. The left image represents the outer surface of the particle, the right image represents half of a particle after a cut (darkened regions) through a particle meridian, and shows its internal, hollow, reaction chamber.

References:

Urich *et al.* (2004) *Biochem. J.* 381, 137; Urich *et al.* (2005) *BBA Prot. Proteomics*, in press.

Prokaryotic Laccases: Integrating Protein Science and Technology.

Lígia Martins : Microbial and Enzyme Technology Laboratory.

The research focus of the Laboratory is in the area of White Biotechnology, *i.e.* industrial and environmental biotechnology. The experimental approaches are multidisciplinary covering biochemistry, microbiology and molecular biology.

One research topic involves the rational design of optimised biocatalysts that better fit industrial applications. The aim is to manufacture industrial bacterial laccases taking advantage of the known structure-function relationships, on the availability of protein engineering tools, and of modern analytical techniques. Laccases are biocatalysts that can replace harsh chemicals that cause environmental contamination in a variety of industrial processes, in particular in pulp delignification, textile dye bleaching, effluent detoxification and organic chemistry synthesis. As a model system the bacterial CotA-laccase from *Bacillus subtilis* is being studied. To attain the above objectives site-directed mutagenesis and biochemical studies are being followed synergistically with X-ray structure determinations and molecular modeling (internal collaborations). A search for novel prokaryotic laccases, better expression systems and fermentation strategies for the production of recombinant laccases, are also being developed and optimised.

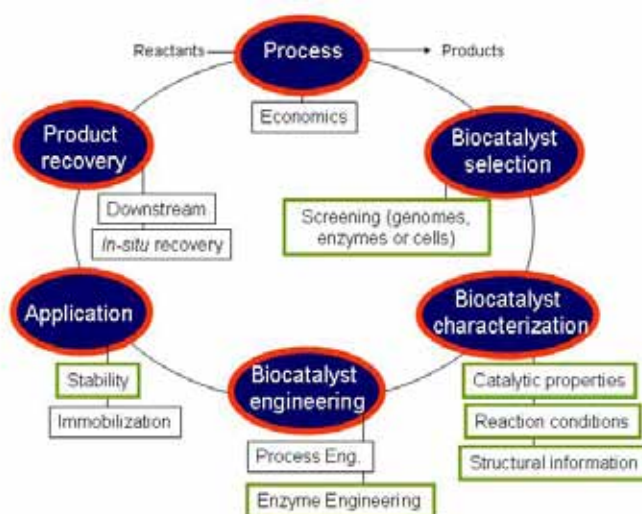

Different steps in discovery and improvement of new biocatalysts. The strategy for obtaining tailor-made enzymes of industrial interest will be based on a "biocatalyst cycle" (Schmidt *et al.* 2001, *Nature*, 409: 258) involving different steps that will be improved in an iterative manner.

Another research topic addresses the development of biodegradation technologies; in particular we are engaged in an EU project aimed at the environmental bioremediation of industrial textile dyes (azo and anthraquinone). Textile dyes are designed to resist fading upon exposure to sweat, light, water, oxidising agents and microbial attack. About 15% of annual synthetic dye production is released in industrial effluents where the dyes are barely removed by conventional wastewater treatment. Their persistence in the environment occurs and raises problems as they are known to be toxic, mutagenic, or carcinogenic compounds. We are currently screening bacteria able to degrade these xenobiotics from a collection of soil micro-organisms, including several *Pseudomonas*, *Sphingomonas*, *Ralstonia*, *Xanthomonas* and *Bacillus* strains. The identification of enzymes and genes involved in dye degradation will allow the characterization of catabolic pathways that combined with studies in microbial physiology and gene technology will enable the experimental evolution of new or improved catabolic activities towards such pollutants.

Superoxide Detoxification by anaerobes.

Miguel Teixeira : Metalloproteins and Bioenergetics Laboratory.

Superoxide is a toxic radical generated in living systems whenever they are exposed to dioxygen. Although its formation is unfavourable inside the highly reductive cell medium, superoxide is produced due to the presence of catalysts such as transition metal and flavins. Superoxide plays a key role in a large number of diseases including cardiovascular and neurodegenerative diseases, aging and cancer. To deal with oxidative stress, both aerobes and anaerobes, that face continuous or transient exposure to oxygen, have developed specialized detoxifying systems. Superoxide dismutases are efficient superoxide-scavenging enzymes, widespread among the three life Domains, which catalyse the dismutation of superoxide with a very high rate of $10^9 \text{ M}^{-1}\text{s}^{-1}$. Organisms rely on SODs as a first line of defence against oxidative stress, and in the absence of this enzyme, the toxicity of oxygen is largely increased.

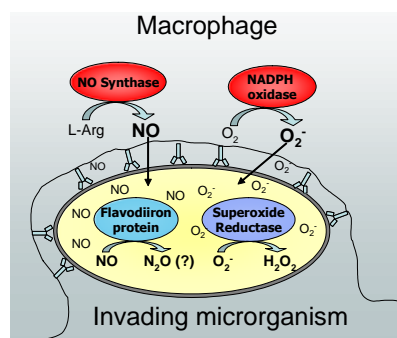

Some organisms have been exploring superoxide's killing potential to their own benefit, using it as a weapon against invading pathogens. This is especially important in the mammalian immune system, where the macrophages, activated by the presence of the pathogen, produce superoxide upon phagocytosis.

Recently a new type of activity was found in anaerobes and microaerophilic bacteria, including pathogens, against superoxide: superoxide reductase (SOR):

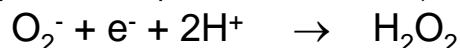

These enzymes, in contrast to SODs, only catalyse the reduction step of superoxide, but with comparable reaction rates ($10^9 \text{ M}^{-1} \text{ s}^{-1}$), as determined by pulse radiolysis studies. The active site of these enzymes is composed of an iron ion coordinated by four equatorial histidines and an axial cysteine. Interestingly, despite of the structural and functional differences between SOR and SOD, there is a common feature in both types of superoxide scavenging enzymes; the presence of a positively charged entrance to the active site, which directs superoxide by electrostatic attraction. SORs receive electrons *in vivo* from rubredoxin, a small redox protein, which in turn is reduced by a NAD(P)H:rubredoxin oxidoreductase. The detailed study of the reaction mechanism of the *A.fulgidus* SORs led us to propose that superoxide reduction occurs through the formation of an iron-hydroperoxide species.

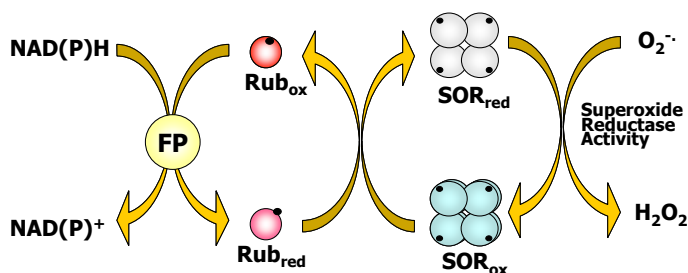
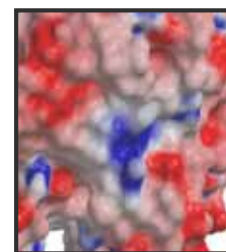
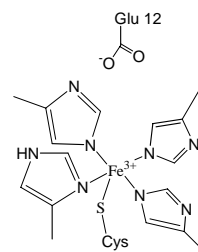

The Reduction of Di-oxygen by the Multi-copper Oxidases.

Peter F. Lindley : Directorate.

The multi-copper oxidase family of enzymes oxidise substrate molecules by accepting electrons at a mononuclear copper centre and transferring them to a trinuclear centre. Di-oxygen binds to the trinuclear centre and following the transfer of four electrons is reduced to two molecules of water. The precise mechanism of this reduction is unclear, but recent X-ray structural studies [1] using the CotA endospore coat protein from *Bacillus subtilis* have given further insights into the principal stages. It now appears that the mechanism involves binding of the di-oxygen into the trinuclear centre so that it is sited approximately symmetrically between the two type 3 copper ions (Cu2 and Cu3) with one oxygen atom close to the type 2 copper ion, (Cu4), Figure (a).

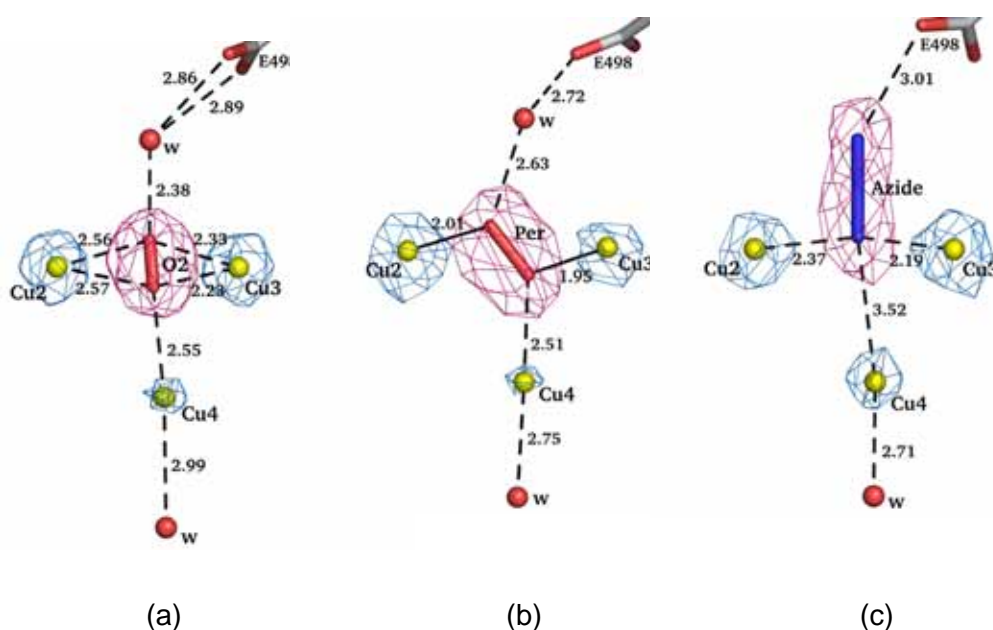

Further stages involve the formation of a peroxide intermediate, Figure (b), and following the splitting of this intermediate, the migration of the two hydroxide moieties towards the solvent exit channel at the far side of Cu4.

The migration steps are likely to involve a movement of the type 2 copper ion and its environment. Figure (c) shows the binding of the inhibitor azide, N_3^- , to the trinuclear copper centre. The inhibitor mimics the binding of oxygen and thus prevents it from accessing the trinuclear centre.

- [1] Isabel Bento, Lúcia O. Martins, Gonçalo Gato Lopes, Maria Arménia Carrondo and Peter F. Lindley. (2005), to be submitted to Dalton Transactions.

TECHNOLOGY

TECHNOLOGY DIVISION : Objectives and Activities.

The Technology Division encompasses Engineering Sciences related to chemical and biochemical systems as well as some components in Microbial and Enzyme Technologies related to foods, pharmaceuticals, fine chemicals, and the environment. The Division is one of the main links with the private-not-for-profit Institute, IBET. Within the functions contracted under the Laboratório Associado, the Technology Division has contributions in three of the five areas: Biologically Active Molecules, Human and Animal Health, Biological Risk Assessment.

The Division was evaluated in October 2004 by an international panel composed of Professor Joachim Klein (Chair, Braunschweig), Professor Daniel Wang (MIT), and Professor Manuel Mota (Minho). The panel recognized the good performance of the Division, and pointed out some recommendations and new opportunities. Brief accounts of each Group now follow.

At the **Animal Cell Biotechnology** Laboratory, Manuel Carrondo and Paula M. Alves have conducted research and development for complex biopharmaceuticals (vaccines, gene therapy bioreactors and cells for therapy and regenerative medicine). Three unifying themes are present: (i) process integration (up- and downstream), (ii) kinetics of infection (adenovirus and retrovirus in mammalian, including human, cell lines), baculovirus in insect cells or *E. coli*, a rickettsial bacteria in endothelial cells and (iii) systems biology approaches. Highlights for 2004/2005 include: (1) Cell handling and cell programming using surface interaction leading to differentiated cells for medical therapies (CellPROM), (2) Studies on the metabolism of brain cells involving the development of alternative culture systems for the growth of primary brain cells in bioreactors, (3) Development and establishment of the best production process for rotavirus-like particles (RLP's) using baculovirus infected cells and in particular fundamental studies on the genetics and kinetics of RLP's synthesis using multigene and single gene baculovirus infection, (4) Studies of adenovirus-based vector production and stability leading to the development of efficient and biocompatible storage formulations for AV recombinant, (5) Development and optimization of Retrovirus (RV) production processes including RV purification methods and cell metabolism to understand the rate of RV production and decay with a view to devising improved RV production and storage.

The **Physiology of Environmentally Conditioned Microbiota** Laboratory, headed by Maria Vitória San Romão, has several objectives for 2005. The studies of bacteria diversity in wine will be essentially focussed on the research of *Oenococcus oeni* surviving mechanisms. As part of this work, the study of the mechanisms of biogenic amines formation in wine has progressed and will continue. Investigations on the environmental control of biogenic amines formation by lactic and acetic bacteria have been started. This work is being done in cooperation with EVN and Rogério Tenreiro from FC-UL. The study of the proteolytic system of *O. oeni* was continued in cooperation of M. T. Barreto Crespo and C. Arraiano. Phenotypic and molecular methods are being improved to identify and to quantify the different fungi present in cork. Moreover, the fungi effect on cork stopper quality is being continued, studying both their ability to degrade polychlorophenols and to produce chloroanisols (cooperation with L. Vilas Boas - ITQB/IST), Rozário Bronze (ITQB/FFUL) and A.S. Curvelo Garcia (EVN). The influence of moulds on cork chemical and physical properties was finished (Cooperation with IGC and ISA). The enzymatic machinery of these fungi was studied.

The **Nutraceuticals and Controlled Delivery** Laboratory, headed by Catarina Duarte, conducts work on the development of clean processes, involving alternative green technologies for the isolation of bioactive concentrates from natural sources, the development of new functional foods/nutraceuticals and the preparation of improved delivery systems, and the exploitation of new solvent systems such as supercritical fluids. Laboratory and pilot plant high-pressure equipment are being used to extract and isolate products with high added-value and application in the food, cosmeceutical and/or pharmaceutical industries. The main activities are very interdisciplinary, hence several collaborations with different research groups with expertise in distinct areas were established and are encouraged. In collaboration with the Animal Cell Biotechnology Laboratory, Instituto Gulbenkian de Ciência and Faculdade de Farmácia, UL, the biological properties of isolated natural extracts are assessed at cellular level in appropriate cell lines searching for protection responses to environmental stresses and cell death signals. Anti-inflammatory response, immuno induction and/or suppression, and anticholesterolemic effects are also studied. In the field of material science and particle engineering, the impregnation, encapsulation and micro/nano-scale particle formation using non-conventional techniques, namely methods that use supercritical carbon dioxide, are being developed. Polymeric and lipid-based formulations with specific properties are being prepared, so that they can act as effective pharmaceuticals/nutraceuticals delivery systems with application in the pharmaceutical industry. Alternative clean processes for the impregnation of some polymeric matrixes (namely contact lenses) with ophthalmic active drugs have been developed and patented. A new semi pilot-scale apparatus for particle formation by rapid crystallisation using supercritical CO₂ as an anti-solvent (SAS method) was constructed. Experiments on the preparation of microspheres impregnated with bioactive compounds are being performed using anti-inflammatory drugs and ethylcellulose, methylethylcellulose, PEG and PLA as carriers.

The Laboratory of the **Microbiology of Transformation and Conservation of Olives and Other Plant Products**, headed by Cidália Peres, directs its activities towards table-olive fermentation, according to INIAP priorities. Two main lines of research are pursued in this laboratory; (1) Technological aspects of table olive manufacturing; and (2) the study and applications of *Lactobacillus* metabolites. Both lines are related since *Lactobacillus* strains are of utmost importance in table-olive fermentation processes, and some strains are bacteriocin producers. Their ecological importance has been evaluated by testing the use of these strains as starters. The influence of olive composition, technological aspects, and metabolites from different bacterial populations on bacteriocin production has been evaluated as part of the overall knowledge about table olive fermentation, and this will help to control the process. The next objective is to control the production of bacteriocins by altering physical parameters or by slightly adjusting brine composition. Routine methods to screen bacteriocin producers have been established. Some bacteriocin producers were selected for more extensive studies, mainly based on the stability and antimicrobial spectra of their bacteriocins. Some of these compounds were found to be active against bacteria that carry multiple resistances to antibiotics. Methods for the purification and characterization of bacteriocins and other inhibitory compounds have been developed. During the current year we expect to develop studies on two recently submitted projects: one aims at obtaining a probiotic or derived component anti-*Helicobacter*, from *Lactobacillus*: *Lactobacillus* spp. Efforts will be made to identify the active compounds. Live bacterial strains and respective active extracts will be patented, aiming at a future application in the treatment of *H. pylori* infections. A further project deals with an evaluation of the waste water troughs for the recovery of valuable compounds, such as β -hydroxytyrosol (for applications in pharmaceutical industries) and manitol (to be used as an additive in food industries).

In the **Mass Spectrometry** Laboratory, headed by Ana Coelho, the main research interests can be divided in two fields; (1) study of biomolecules and biological systems, and (2) studies involving chemical systems and small molecules. With respect to the first interest, projects have been initiated that include the use of MS methodologies for protein identification and for the characterization of post-translational modifications. The most relevant projects being undertaken in this area are; “The effects of phenolic compounds in taste sensitivity: cell kinetics, chemical and morphological adaptations in the oral cavity”, “In search of new molecular targets for the development of novel therapeutic strategies for cystic fibrosis”, and “Gene expression changes during hepatitis delta virus infection - analysis of the cellular proteome”. Some studies have been done on the particular behaviour of metalloproteins when submitted to MALDI and electrospray ionisation processes. Studies of protein-protein interactions, namely in virus-like particles and protein complexes involved in the cell cycle, have also been performed by mass spectrometry procedures. H/D exchange and plasmon resonance techniques have been used in the projects, “Genetics, stoichiometry and kinetics of protein packing in Rotavirus like particle” and “Structural and functional characterization of the kinetochore from *D. Melanogaster*”. Studies on chemical systems and small molecules have included the characterization of plant extracts composition and the identification of relevant compounds for the pharmaceutical and food industries. Typical examples are “Characterization of olive, olive oil and sub products extracts by LC-MS” and “Identification and quantification of antioxidants in food industry residues”. Other projects have included the development and optimisation of MS methods for the characterization of particular types of chemical compounds, namely macrocycle-guest complexes, organo-metallics, and ionic liquids.

The **Microbiology of Man-Made Environments** Group, headed by Maria Teresa Crespo, continued its research in aspects related to food safety especially concerning the presence of *Enterococcus* spp. in traditional food products. Studies on the detection and expression of virulence factors in this genus were performed and will continue in 2005, currently focusing on joint responses between microbes and animal cell lines, in cooperation with Animal Cell Biotechnology group. The study of the evolution of microbial communities related to food products and water will also be a main topic for the laboratory as a follow up to the present work. The work of the Microbiology Laboratory of the Good Laboratory Practices Unit of IBET has maintained its steady trend of GMO (genetically modified organisms) analysis for the Portuguese government and private companies. The cooperation with the Joint Research Centre of the European Union (Ispra, Italy), through the European Network of GMO Laboratories, has continued. Moreover, the implementation of a bioassay for a Portuguese pharmaceutical company has proved of special relevance. Implementation of other assays for pharmaceutical companies is in progress.

The **Biomolecular Diagnostics** Laboratory, headed by Abel Oliva, aims to develop molecular diagnostics, mainly for veterinary applications (ELISA, Reverse Line Blot, immunosensors), as well as in the development of devices for bioprocess monitoring. An optical immunosensor based on the fluorescence of cyanine 5 has been developed to diagnose ovine Brucellosis and bovine Anaplasmosis. As a first application, a sandwich immuno-reaction to detect anti-*Brucella* sp. antibodies in infected animals was used with an ovine serum sample infected with *Brucella* sp.. For this assay a recombinant antigenic protein from *Brucella* sp., BP26, was employed. As a second application, a major surface protein 5 (MSP5) B-cell epitope conserved *Anaplasma* species was used. An assay was performed using a sandwich immuno-reaction to detect serum samples infected with *Anaplasma* sp. In addition, identification of antigenic proteins from a recently described Chinese *Theileria* sp. provided the first step for a new project, followed by the characterisation and purification of these proteins. In this project the development of parasite culture in erythrocyte cells has

been developed in order to produce biological material without limitations. For bioprocess monitoring an instrument for the measurement of dissolved oxygen is under development in collaboration with the Optoelectronic group, INESC/ Porto, as well as a device for measurement of cellular density in fermentors, in collaboration with the UNICAM/UNL. A study of immobilization supports and protocols to bind specific proteins for immunosensor applications has been performed. A new family of porous glass (TRISOPERL®) has been characterized and selected, according to its immobilization capacity and physicochemical properties, for application with the laboratory optical immunosensor prototype.

The **Antibiotic Stress and Virulence of Enterococci** Laboratory, headed by Fátima Lopes, is developing studies aiming at addressing two key issues; to understand, in a food safety perspective, why, how, and when, resistance and virulence genes carried by food enterococci are expressed and to search for new targets or substances in order to get ways to overcome the antibiotic resistance problem. In the last decades, it has become apparent that community and environmental reservoirs represent significant sources of antimicrobial-resistant enterococci. In particular, enterococci isolated from milk and traditionally made cheeses are less resistant to antibiotics than the clinical ones, but carry some of the genes responsible for antibiotic resistances and virulence factors. These will continue to be the instruments of study, together with some clinical specimens. The specific objectives are to elucidate virulence factors, to colonize and study the persistence abilities of the food enterococci (this research will address the pathogenic potential of those bacteria and assess precisely the threat that these bacteria pose to human health), to understand how antibiotic doses influence the survival of susceptible populations, to understand the extent of food enterococci as reservoirs of resistance and virulence genes and their potential as givers and donors of those genetic traits, to gain mechanistic insight into how bacteria sense and respond to their environment at the level of the cytoplasmic membrane (some of the environmental factors studied include antimicrobials), to fingerprint the bacteria response to antibiotic selection pressure, namely at the proteome level and to search for new substances that could constitute good candidates for new antimicrobials.

The **Processes in Supercritical Fluids** Laboratory under the leadership of Manuel Nunes da Ponte and Catarina Duarte have conducted research on the development of Clean Technologies using Supercritical Carbon Dioxide, namely i) the extraction from solids and fractionation of complex liquid mixtures, ii) chemical reaction (hydrogenation, oxidation with air), iii) induced phase changes in (ionic liquid, water and ethanol mixtures) for solutions with application to biphasic catalysis, iv) emulsions for protein transport and v) impregnation of polymers with pharmaceuticals. One of the on-going projects in the area of Delivery/Nutraceuticals, (water+ethanol mixtures and supercritical CO₂) has been used to extract from food residues (wine and olive oil wastes) concentrates of antioxidants containing high-value biologically active substances, such as resveratrol and hydroxytyrosol. Incorporation of the extracts in commercial products will be explored. In collaboration with the Animal Cell Biotechnology Laboratory and Instituto Gulbenkian Ciência, bioactivity tests and analysis of RNA expression are under study and will be continued during 2004. The use of emulsions (with several bio compatible emulsifiers) to transport different proteins in supercritical CO₂ will continue to be explored. A lab-scale apparatus for sorption measurements of CO₂ into polymers has been built. Two new semi pilot-scale apparatus for particle formation by rapid crystallisation using supercritical carbon dioxide are under construction. These two devices are based upon different techniques (SAS:supercritical antisolvent and PGSS: particles from gas saturated solution) and will be developed to prepare delivery systems with interest to the pharmaceutical or food industries.

At the **Molecular Thermodynamics** Laboratory, Luís Paulo Rebelo and co-workers have focused their major attention during 2004 on the new emerging area of Ionic Liquids as potential substitutes for common volatile organic compounds. Pioneering work was performed both in respect to their thermodynamic characterization in wide pressure and temperature ranges as well as to their solution behaviour. In the latter case, a huge co-solvent effect between water and alcohols was found in their solutions with ionic liquids. This fact can profitably be used as a switching device to trigger situations of total miscibility, partial miscibility, or almost complete phase separation. The aforementioned effect may come to play an important role in the recovery of alcohols produced in fermentation processes using ionic liquids. In addition, lower critical solution temperatures (LCST) a type of phase diagram, including the presence of closed loops, have been encountered for the first time in binary and quasi-binary liquid solutions of ionic liquids and organic solvent. The results constitute the first experimental support for the existence of a theoretically postulated, but never encountered, special kind of type VII phase diagram. Two distinct mechanisms are involved in the appearance of demixing upon temperature increase. These findings imply the presence of specific, oriented interactions between the ionic liquid and the organic solvent as well as aggregation phenomena. For 2005 it is foreseen that extensive studies on the interaction between ionic liquids and aqueous macromolecular solutions will be performed aiming at understanding the influence of ILs on aggregation and micellar phenomena. Solubility studies of polymers in ionic liquid media are also anticipated.

The Group of **Analytical Tools and Quality in Pharmaceutical Chemistry**, headed by Ana Luísa Simplício, aims at providing solutions for separation needs, at the analytical scale, in the field of pharmaceutical chemistry. Since the work will be undertaken under the auspices of the Laboratório Analítico (IBET), which is GLP certified, we are in a privileged position to cooperate with the pharmaceutical industry and also with other ITQB groups. We expect to develop competence in the field of specialized separation science involving chiral chromatography and electrophoresis as well as capillary gel electrophoresis and capillary electro-chromatography for protein analysis. Work has already been initiated with the Animal Cell Biotechnology and the Mass Spectrometry Laboratories. Research will be conducted related to prodrug design and targeted delivery. To reach this goal cooperation will be required from some of the synthetic organic chemists, and it is expected to obtain this within the institute (a collaboration has already been initiated with the Organic Synthesis Laboratory) or other partners (project submitted to the FCT with the IST). The assessment of the performance (drug-protein binding, bioavailability and pharmacokinetics) and risk of biologically active molecules and pharmaceutical formulations as well as metabolism and impurity profiling will also be among our skills (ongoing work with the Nutraceuticals and Delivery Laboratory).

The goal of the **Biomathematics Laboratory** is the quantitative analysis of biological systems with special emphasis on the identification of unifying quantities and methodologies. This objective is pursued by multidisciplinary collaborations with other groups at ITQB and elsewhere. From a methodological point of view, the claim for originality of this Laboratory is the use of the structure and behaviour of biological systems as a model for the development of data analysis techniques - Biology as a model for Mathematics. This inversion of Galileo's cornerstone formulation - *Mathematics is the language of Nature* - is at the core of the ongoing revolution in Biomathematics. It has been made possible by the advent of parallel processing, which enables simulation of the networked multi-agent nature of biological systems.

For 2005, the objectives of the **Pilot Plant**, headed by António Cunha, can be divided into three different categories; research and development, contract services, and

construction of a production area for operation according to Good Manufacturing Practices (GMP). The research and development work will be performed mainly in the bioreaction area. The development of hybrid models for bioprocesses applied to bioreaction process control and optimisation, in collaboration with Sebastião Feyo Azevedo (ISR/FEUP) and Rui Oliveira (FCT/UNL) will be one of the main areas of research, being the model development performed using a *Pichia pastoris* strain expressing a recombinant antibody fragment. The models developed will also be applied in the scope of other processes under development whenever possible. New vaccines are being developed for strangles (a disease affecting horses) using either protein extracts from streptococcus equi equi, or an M-like protein expressed in recombinant E.coli strains, in collaboration with António Almeida (FF/UL). The development of starter cultures of table olive fermentation in collaboration with Cidália Peres (INIAP), Maria Amália Peito (INETI), Apafna, and Probeira will be continued. Collaborations with the Animal Cell Biotechnology Laboratory and the Macromolecular Crystallography Laboratory will also be continued and developed, as well as the bioreaction work in support of work developed by several ITQB groups. Contract services will be continued, namely with Schering and Merck, an important objective being to increase the use of this service by medium size European pharmaceutical companies. A new area will be built according to the requirements of the GMP rules, and equipped with bioreaction and purification equipment that will allow the Pilot Plant to provide a complete service in the development of new biopharmaceuticals, from the R&D stage to the production of batches for preclinical and clinical trials.

Highlights for the Laboratories of Paula Alves, Fatima Lopes and Ana Luísa Simplício can be found in the section on the Laboratório Associado.

TECHNOLOGY DIVISION – STAFF.

Laboratory : Biosensors (Optical sensors / immuno-sensors)

Head of Laboratory : Abel Oliva

Research Team :

Helder Cruz	Ph.D.
Joana Miranda	Ph.D. Student
José Palmeira	Master Student
Marta Gomes	Graduate Student
Elisabete Nascimento	Research Assistant
Óscar Silvestre	Undergraduate Student
José Vicente	Undergraduate Student
Miriam Azevedo	Undergraduate Student

Laboratory : Nutraceuticals / Delivery

Head of Laboratory : Catarina Duarte

Research Team :

Rui Ruivo	Post-Doc
Ana Rita Duarte	Ph.D. Student
Raquel Sousa	Ph.D. Student
Ana Nunes	Graduate Student
Ana Teresa Serra	Graduate Student
Ana Marias	Graduate Student

Laboratory : Antibiotic Stress and Virulence of Enterococci

Head of Laboratory : Fátima Lopes (see also Laboratório Associado Section)

Laboratory : Biomathematics

Head of Laboratory : Jonas S. Almeida

Research Team :

António Marezek	Ph.D. informatics consultant
Isabel Oliveira	Post-Doc
Andreas Bohn	Post-Doc
João Carriço	Ph.D. Student
Sara Garcia	Ph.D. Student
Francisco Pinto	Ph.D. Student
Lukas Müller	Graduate Researcher
Susana Vinga	Ph.D. Student
Pedro Eleutério	Graduate Student
Helena Deus	Graduate Student

Laboratory : Microbiology of Man-Made Environments (Ecology / Microbiota)

Head of Laboratory : Cidália Peres

Research Team:

José Joaquim Figueiredo Marques	Ph.D.
Maria Dulce Azevedo Carneiro de Brito	Ph.D.
Amélia Maria Muralha Delgado	Ph.D. Student
Ana Dâmaso	Undergraduate Student
Cristina Serrano	Research Technician
Luisa Reis	Technician
Luís Catulo	Technician

Laboratory : Molecular Thermodynamics (Isotope Effects/ Polymer Solutions/
Metastable Liquids/ Sound Propagation in Dense Phases/ Ionic Liquids)

Head of Laboratory : Luís Paulo N. Rebelo

Research Team:

Joanna Lachwa	Post-Doc
Zoran Visak	Post-Doc
José Esperança	Post-Doc
Marijana Blesic	Ph.D. Student

Laboratory: Processes with Supercritical Fluids (Supercritical CO₂ / extraction and reaction)

Head of Laboratory: Manuel Nunes da Ponte

Research Team:

Anna Bannet	Post-Doc
Joana Fonseca	Post-Doc
Ewa Boge-Lukasik	Post-Doc
Vesna Najdanovic-Visak	Ph.D. Student Post-doc
Ana Serbanovic	Ph.D. Student

Laboratory: Microbiology of Man-made Environments (Food & Environment)

Head of Laboratory: Teresa Crespo

Research Team:

Helena Isabel dos Santos	Ph.D. Student
Ana Teresa Pires	Graduate Student
Humberto Silva	Graduate Student
Inês Manarte	Graduate Student
Luísa Andrade	Graduate Student

GLP Section :

Fernanda Spínola Rodrigues	GLP Study Director
Cátia Morgado Peres	GLP Study Director
Cristina Isabel Pereira	GLP Study Director /Ph. D. student
Susana Tenedório	GLP Technician

Laboratory: Animal Cell Biotechnology (Biologicals for therapies and diagnosis / cell and gene therapy)

Heads of Laboratory: Manuel J.T. Carrondo and Paula M. Alves

Research Team :

Pedro Estilita Pereira Monteiro Cruz	Ph.D.
Helena Vieira	Post-Doc
Changhe Zhang	Post-Doc
Ana Sofia Coroadinha	Ph.D. Student
Cláudia Istrate	Ph.D. Student
Isabel Eloi Marcelino	Ph.D. Student
Marlene Isabel Rosa do Carmo	Ph.D. Student
Sónia Adelaide Queirós de Sá Santos	Ph.D. Student
Teresa Rodrigues	Ph.D. Student

Tiago Bruno Pereira Soares Ferreira	Ph.D. Student
Catarina Esteves	Master Student
Ana Lúcia Ferreira	Technician
Cristina Peixoto Lisboa	Technician
Marcos Filipe Quintino de Sousa	Technician
Maria do Rosário Clemente	Technician
Ana Carina Ferreira da Silva	Graduate Student
Célia Casado Veríssimo	Graduate Student
Joana Ribeiro	Graduate Student
Hugo Costa	Research Student
Margarida Serra	Research Student
Rita Malpique	Research Student
António Roldão	Research Student
Leonor Norton	Research Student
Ana Catarina Pereira	Undergraduate Student
Tiago Cardoso Alves	Undergraduate Student
Sofia Leite	Undergraduate Student
Ana Isabel Amaral	Undergraduate Student

Laboratory: Microbiology of Man-Made Environments (Stress/wine quality)

Head of Laboratory: Maria Vitória San Romão (Stress, Wine quality)

Research Team:

Cristina Silva Pereira	Post-Doc
Sónia Vitorino	Ph.D. Student
Ana Paula Marques	Graduate Student (IBET/Agro))
Frédérique Gaspar	Graduate Student (IBET/FCT)
Maria do Carmo Basílio	Graduate Student (IBET/Amorim & Irmão)
Ricardo Gaspar	Graduate Student
Vera Basto	Undergraduate
Maria Cristina Jorge Leitão	Technician

Laboratory: Mass Spectroscopy

Head of Laboratory: Ana Maria Varela Coelho.

Research Team:

Gonçalo Conde da Costa	Ph.D. Student
Judite Maria Marques Dias	Ph.D. Student
Patrícia Gomes Alves	Ph.D. Student
Marta Lavoura Mendes	Master Student
Catarina Ferraz Franco	Research Student
Gonçalo Graça	Undergraduate Student
Cíntia Penque Vicente	Undergraduate Student
Elisabete Pires	Laboratory technician

The Use of Immunosensors in the Identification of Animal Diseases.

Abel Oliva : Biosensors Laboratory

In veterinarian diagnostics, the identification of animal diseases is often based on immunological techniques, including immuno-fluorescence and ELISA, but these are normally expensive and slow. Immunosensors take advantage of the high specificity and sensitivity of antibodies, allowing analytical measurement by the transduction of a parameter of the antigen-antibody reaction into an electrical signal, and thus enabling fast diagnostics.

The Biosensor Laboratory is working on the identification of antigenic proteins of a recently described *Theileria sp.* parasite. It causes a tick borne disease that affects small ruminants in China, inducing severe losses in a vast region of Asia. The identification of antigenic proteins from *Theileria sp.* (China) merozoites was the first step of this work, followed by the characterisation and purification of these proteins. In order to avoid seasonal limitations of the availability of parasite antigens, development of parasite culture in erythrocyte cells has been developed.

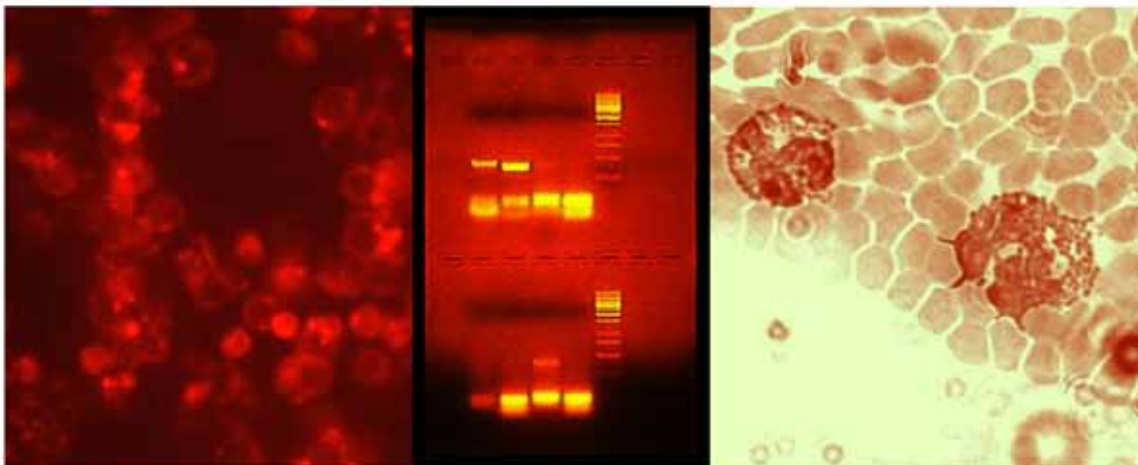

Several approaches were considered; 1) construction of a *Theileria sp.* (China) cDNA library and its screening with antisera, 2) screening of other *Theileria* species with *Theileria sp.* (China) antisera, 3) testing the existence of other *Theileria* species for previously identified genes in *Theileria sp.* (China) to see if they are antigenic for *Theileria sp.* (China), 4) Recombinant production and purification of the identified antigenic proteins. In a final step the characteristics of these proteins will be analysed regarding their suitability for early detection diagnostics, either based on ELISA or immunosensor systems, or for therapeutic purposes as a vaccine candidate.

In addition, an optical immunosensor based on the fluorescence of cyanine 5 was developed to diagnose ovine Brucellosis and bovine Anaplasmosis. As a first application, a sandwich immunoreaction to detect anti-*Brucella sp.* antibodies in infected animals was used with an ovine serum sample infected with *Brucella sp.* For this assay a recombinant antigenic protein from *Brucella sp.*, BP26, was used. In a second application, a major surface protein, 5 (MSP5) B-cell epitope conserved *Anaplasma* species, was used. An assay was performed using a sandwich immunoreaction to detect serum samples infected with *Anaplasma sp.*

Preparation of Drug Delivery Systems with Supercritical Carbon Dioxide.

Catarina Duarte : Nutraceuticals and Delivery Laboratory.

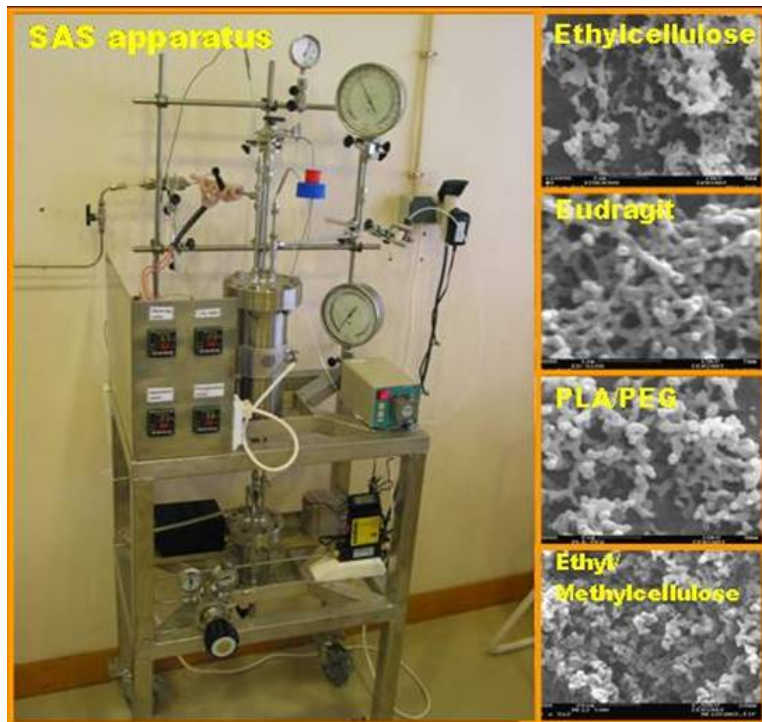

It has recently become more and more evident that the development of new drugs alone is not sufficient to ensure progress in drug therapy. The development of suitable carrier systems is fundamental to overcome the problems related with the administration of some drugs. Controlled drug delivery products, using biocompatible or biodegradable polymers and/or lipidic matrices, have received considerable attention in the last few years. These substances provide in general a more controlled rate of assumption of the drug by the body improving its therapeutic action.

Supercritical fluid (SCF) technology has been shown to be a viable option in the formulation of particulate drug delivery systems, such as micro-particles and nano-particles, liposomes, and inclusion complexes, which control drug delivery and/or enhance the drug stability. A new semi pilot-scale apparatus for particle formation by rapid crystallisation using supercritical carbon dioxide has been constructed. This device is based upon the SAS (supercritical anti-solvent) technique and is being used to prepare micro and/or nano-scale delivery systems with interest to the pharmaceutical, cosmeceutical or food industries.

An alternative clean process, using supercritical carbon dioxide, for the impregnation of some polymeric matrixes with biological active drugs has been developed and applied. Experiments on the preparation of micro-spheres impregnated with bioactive compounds have been performed using anti-inflammatory drugs and ethylcellulose, methylethylcellulose, PEG and PLA as carrier materials.

Also, therapeutic finished ophthalmic articles, such as commercially available soft contact lenses and intra-ocular lenses, have been impregnated with drugs used for glaucoma treatment, using the supercritical fluid impregnation technique.

Bioinformatics – Biomathematics for Experimental Biology.

Jonas S. Almeida: Biomathematics Laboratory.

“Mathematics is the language of nature” famously said Galileo and this also true for modern integrative Biology. The Biomathematics Laboratory at ITQB aims at algorithm and theory development in response to experimental and field biology research programs. Accordingly, the emphasis of training and research encompasses areas of statistics and computation in addition to the molecular understanding of Biological Systems. The need to quantify the diversity of biological systems leads to the comparative evaluation or altogether novel identification of metrics and methods to quantify them. The collaborative nature of bioinformatics similarly mandates that the computational tools must be implemented as web-based applications, which justifies the strong technological foundation of this field. Specifically, bioinformatics tool development at the Biomathematics group currently targets the following areas;

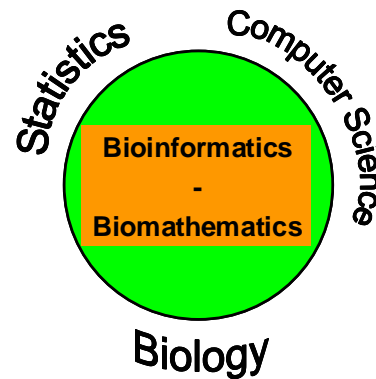

Genomics – using iterative functions and other tools to achieve alignment-free sequence analysis techniques that may be used to probe low similarity sequences, when alignment methods break down. [recent example : Vinga S, Almeida JS (2004) Rényi continuous entropy of DNA sequences. J. Theor. Biol. 231(3) 377-388].

Transcriptomics – standard micro-array analysis techniques are being generalized to enable the incorporation of annotation and regulatory information, by deriving measures of consensus. [recent example: Pinto FR, L Ashley Cowart, Yusuf A. Hannun, B. Roher, J.S. Almeida (2004) Local correlation of expression profiles with gene annotations – proof of concept for a general conciliatory method. Bioinformatics, in press PMID:15509607]

Biological networks - reverse engineering of metabolic and regulatory networks are being pursued to analyze *in vivo* NMR metabolic time series produced at ITQB and elsewhere. [recent example: Voit, E.O., J.S.Almeida (2004) Decoupling Dynamical Systems for Pathway Identification from Metabolic Profiles. Bioinformatics, 20(11):1670-81]

Consortia - Moving to a more complex level, microbial communities aggregate in biofilm structures that possess new and interesting properties. [recent example: Wolf G, Almeida JS, Crespo JG, Reis MA. (2003) Monitoring of biofilm reactors using natural fluorescence fingerprints. Water Sci Technol. 2003;47(5):161-7.]

Statistical Mechanics - For analysis of higher order organisms and communities, new techniques for non-linear time series analysis of physiological system and fisheries are being developed and tested. [recent example: Garcia, S., J.S. Almeida (2005) Nearest neighbor embedding with different time delays. Physical Review E, in press.]

Molecular Epidemiology - And at a level of interaction between microorganisms and humans, Epidemiological Information systems are required to intelligently store and manage data about drug-resistant bacteria and their human hosts. Also the increasing information generated by microbial typing methods, has created the need for new techniques to look at the huge amount of data, and correctly classify them, to better detect and prevent outbreaks in the communities.

[Nunes S, R Sá-Leão, J Carriço, CR Alves, R Mato, A Brito Avô, J Saldanha, JS Almeida, I Santos Sanches, and H de Lencastre (2005) Trends in drug resistance, serotypes and molecular types of *Streptococcus pneumoniae* colonizing pre-school age children attending day care centers in Lisbon, Portugal – a summary of four years of annual surveillance. J Clinical Microbiology, in press.]

Stress and Antimicrobials in Lactic Acid Bacteria.

Cidália Peres: Food Microbial Technology Laboratory.

1. Technological aspects of table olive manufacturing

The ecological importance of *Lactobacillus* strains in table-olive fermentation processes has been evaluated. Strains with relevant technological properties have been tested as starters. The influences of olive composition, technological aspects, and metabolites from different bacterial populations on bacteriocin production have been evaluated as part of the overall knowledge about table olive fermentation. This in turn will help to control the fermentation process by enabling effective alterations of physical parameters and brine composition.



The figures show fractional factorial designs of different brine/fermentation parameters – Response Surfaces.

2. Studies and applications of *Lactobacillus* metabolites.

A recently initiated project aims at obtaining a probiotic or derived components of anti-*Helicobacter*, from *Lactobacillus*. *Lactobacillus* spp, that were isolated during the fermentation of Portuguese table-olives will be tested for direct antagonism against multi-resistant, clinical strains of *H. pylori*, isolated from ulcers and gastritis – see Figure. Efforts will be made to determine the active compounds. Live bacterial strains and respective active extracts will be patented, with a view to future applications in the treatment of *H. pylori* infections.

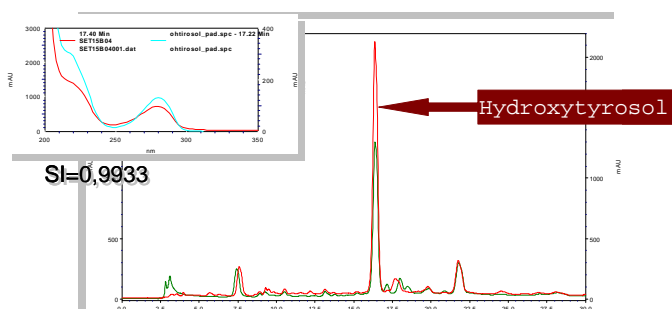

A second project deals with the examination of wastewaters through the recovery of valuable compounds, such as β -hydroxytyrosol (for applications in the pharmaceutical industries) and manitol (to be used as an additive in food industries).

The figure shows a typical HPLC identification of β -hydroxytyrosol with a standard and the peak due to the sample and (inset) the respective UV spectra.

Unusual Liquid-Liquid Phase Splitting in Ionic Liquid Solutions.

Luís Paulo Rebelo : Molecular Thermodynamics Laboratory.

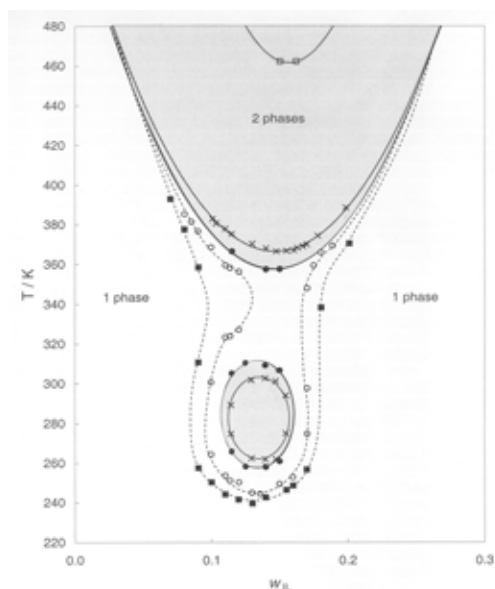

Figure 1. Liquid-liquid phase equilibria of $(C_n\text{mimNTf}_2 + \text{CHCl}_3)$; w_{IL} is the weight fraction of the hypothetical ionic liquid $(C_n\text{mimNTf}_2)$, where n is the average number of carbons in the alkyl chain of the cation; The hatched areas depict the L-L demixing regions for $n = 4.330$

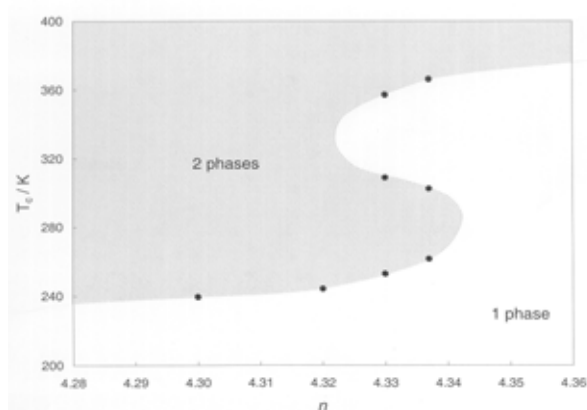

Figure 2. Economical representation of the same phase diagram: critical temperature versus the average number of carbons in the alkyl chain of the cation for the hypothetical ionic liquid $(C_n\text{mimNTf}_2)$ in its mixtures with CHCl_3 .

Two distinct types of liquid-liquid phase splitting in ionic liquid (IL) solutions upon temperature increase have been found. One of them is the result of relatively strong, oriented interactions between the IL and the organic solvent. The other emerges whenever the solvent is significantly expanded compared to the IL. In two of the cases investigated, both types of demixing are present in the same phase diagram, which constitutes the first experimental support for the existence of a recently theoretically postulated type of phase diagram – type VII. Hydrogen bonding between the IL and the organic solvent as well as the formation of a fluctuating mixture of cation-anion contact pairs, $[\text{C}_n\text{mim}][\text{NTf}_2]$, with triple-ion's aggregates, $[(\text{C}_n\text{mim})_2(\text{NTf}_2)][(\text{C}_n\text{mim})(\text{NTf}_2)_2]$, together with the small thermal expansivity of the IL seem to be responsible for this very unusual behaviour.

Osmium-catalyzed asymmetric dihydroxylation.

Manuel Nunes da Ponte: Supercritical Fluids Laboratory.

Osmium-catalyzed asymmetric dihydroxylation (AD) of olefins is one of the most reliable methods for the preparation of chiral vicinal diols which act as intermediaries in the syntheses of many biologically active substances. The obstacles to its large-scale application in the pharmaceutical and fine chemicals industries are the high cost of the osmium catalyst, the toxicity of osmium, and its potential contamination of the product. In collaboration with the group of Carlos Afonso, a synthetic organic chemist who recently moved from NOVA to Técnico, we have developed a method of catalyst immobilization in ionic liquids combined with supercritical CO₂ extraction, which practically eliminates osmium leaching and catalyst loss of activity, making its repeated use possible.

The combination of supercritical CO₂ with ionic liquids as an alternative reaction medium takes advantage of the remarkable properties of both solvents. Due to their ionic nature and negligible vapour pressure, ionic liquids exhibit no appreciable solubility in supercritical CO₂; at the same time, scCO₂ is remarkably soluble in most ionic liquids, and can be used to extract numerous organic substances from them without any IL contamination in the final product.

The breakthrough strategy in this work was to use CO₂ at the lowest possible density, where it can still dissolve the reaction products to some extent, but does not carry any catalyst out of the ionic liquid solution. In these high selectivity conditions, the lower solubility of the product in scCO₂ can be compensated by extracting with higher amounts of the supercritical solvent.

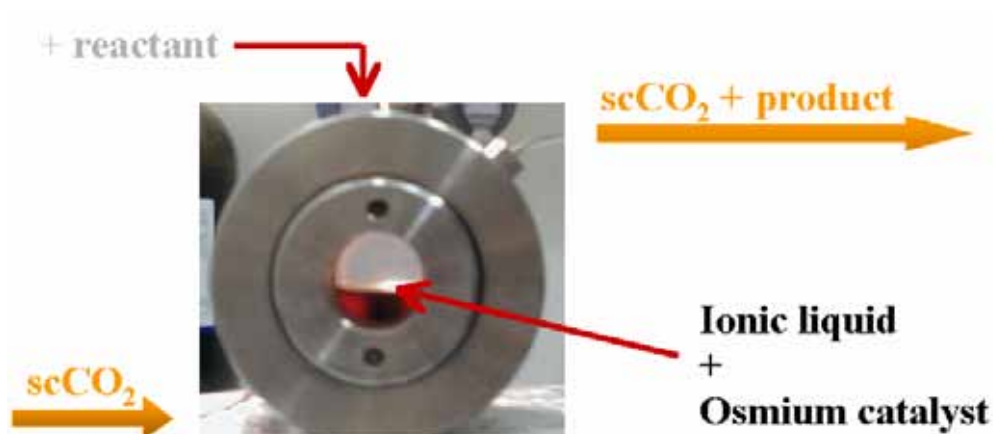

The Dynamics of Growth, Evolution and Activity of Micro-organisms in Cheese.

Maria Teresa Crespo: Microbiology of man-made environments Laboratory, (Food and Environment).

The dynamics of growth, evolution and activity of micro-organisms in food are the result of environmental pressures that happen due to the changes in chemical and physical conditions in the production environment. Cell-to-cell interaction and the growth in heterogenous matrixes also influence the evolution of populations. Cheeses produced from raw ewe's milk are still produced in a traditional way in certain regions of Portugal by relying on colonization by microbial populations associated with raw materials, equipment and local environments.

The comprehension of the dynamics of the populations involved in cheese processing and ripening and the knowledge of the members of the population present will have an impact on the quality and safety of these food products, as well as on the their preservation as part of the Portuguese cultural heritage.

Samples were therefore taken during the cheese production process. Total DNA was isolated and 16S rDNA amplified both in the milk and in different layers of the product. Products were run on a temperature gradient gel electrophoresis (TGGE) and the results show a clear difference in terms of microbial population between a first class product and a product that can not be sold with the stamp of protected designation of origin (PDO). The results will be complemented with the identification of the main population members and eventually can be more finely tuned to being able to predict, in an early stage of production, if a good product will be obtained in the end.

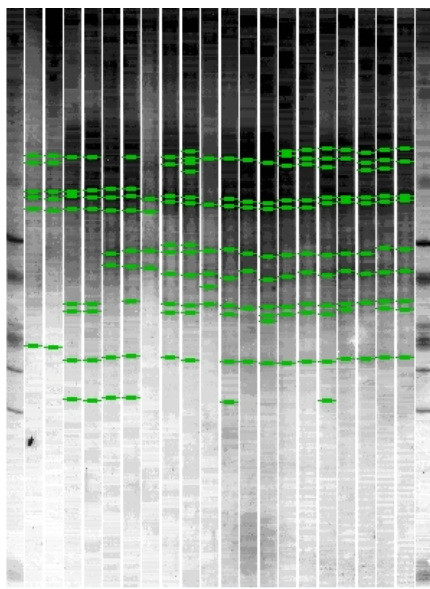

A

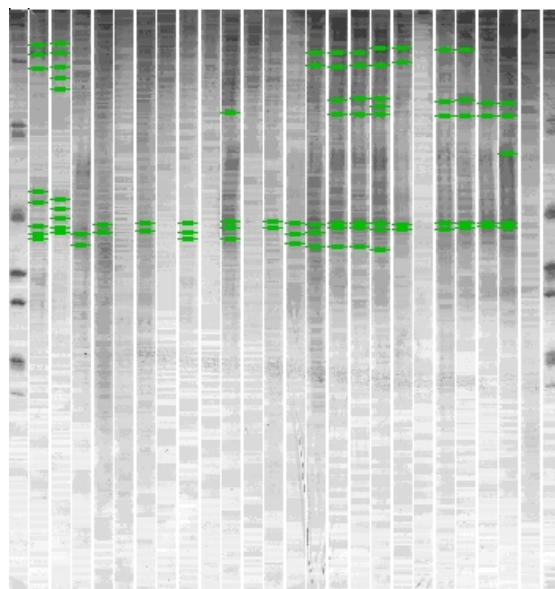

B

Gel A, obtained from a cheese with no Protected Denomination of Origin recognition and gel B, from a cheese with Protected Denomination of Origin recognition, show clearly the differences between both and the potentialities of the technology in terms of quality control.

The Use of double FLP recognition targets (FRTs) for the development of Recombinant Human Cell Lines for the Production of Therapeutic Products.

Manuel J. Carrondo and Paula Alves: Animal Cell Bio-Technology Laboratory.

A wide range of biopharmaceuticals has become commercially available in the last decade that is produced in animal cell cultures. This is the case of therapeutic proteins that, due to their complexity in conformation and post-translation modifications, can only be produced in genetically engineered mammalian cells. It is also the case of even more complex products such as vaccines or viral vectors for use in Gene Therapy.

Although recombinant DNA technology developments in the 1970s supported the development of genetically engineered animal cells, the establishment of novel cell lines for the production of new proteins with high productivities and high quality still poses major difficulties today. Furthermore, expanding safety concerns have driven research for development of safer cell lines.

We tested the use of an Flp/FRT-mediated targeting exchange to tag high expression chromosomal locus with LacZ reporter gene that can be later reused by cassette exchange homologous recombination. This would allow a faster screening and development of high producer cell lines. Two cell lines were tested HEK (Human Embryonic Kidney) cells transformed with an oncogene and RPE (Retinal Pigment Epithelial) cells which were transformed with telomerase, a non oncogenic agent, thus being safer for the production of therapeutic products particularly vaccines or gene therapy vectors. Both cell lines were successfully tagged with the Flp/FRT cassette and high expression β -galactosidase clones were selected. The homologous recombination was then performed with the cassette exchanged for an antibody construct in both cell lines; similar levels of expression were obtained in all subclones analysed.

This confirms the high potential of this Flp/FRT strategy for the fast screening of cell lines and clones for the production of proteins. The telomerase immortalised cell line RPE also showed the ability to produce high quantities of antibody and thus be suitable for therapeutic protein production.

Both tagged cell lines HEK and RPE1 were subsequently used for the development of packaging cell lines for the production of retroviral vectors for use in gene therapy.

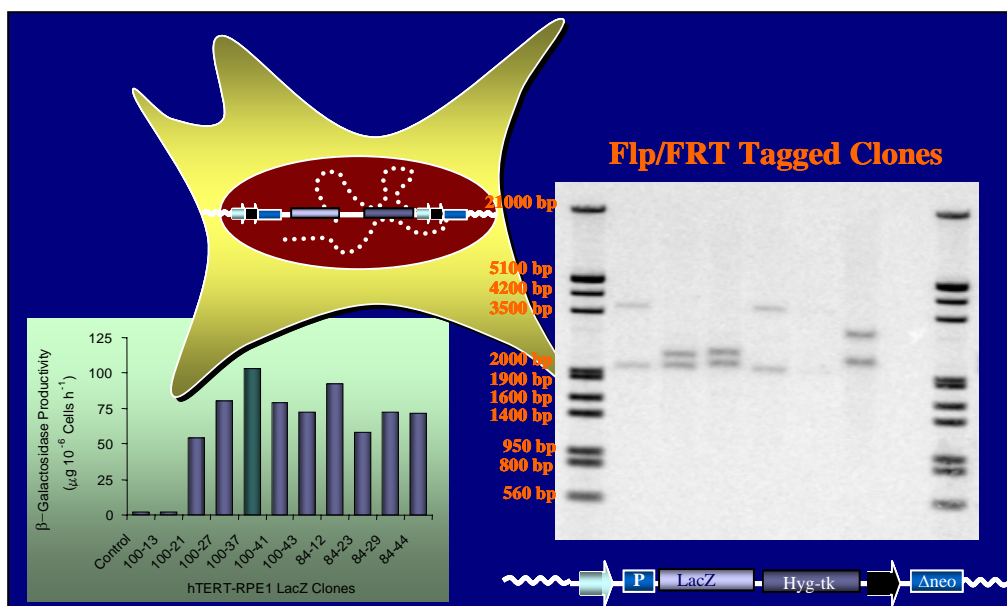

Physiology of environmentally conditioned microbiota - two case studies.

Vitoria San Romão: Microbiology of Man-Made Environments Laboratory, (Stress, Wine Quality).

Amino Acid decarboxilases

Histidine and tyrosine decarboxylase (*hdc*, *tyrdc*) genes were screened in the natural bacterial community of Portuguese wines, in several isolates of malolactic bacteria (MLB) and acetic acid bacteria (AAB). These genes were detected in some isolates of MLB and AAC. Nevertheless, some results suggest they can be repressed or silenced in a wine environment since the production of biogenic amines was undetectable in some assays.

tyrdc gene

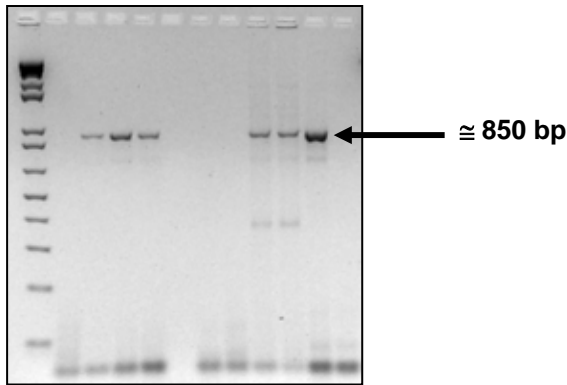

hdc gene

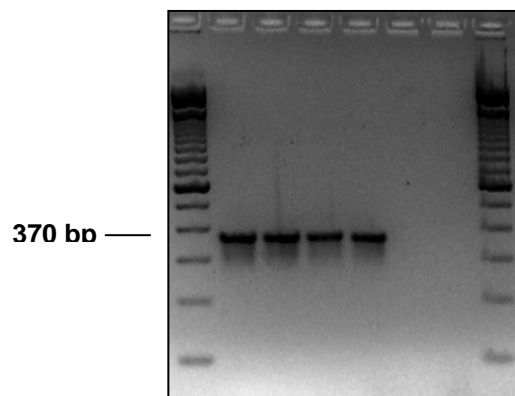

Moulds identification

A significant occurrence of *Penicillium* isolates was found throughout the manufacturing process of cork stoppers. Thirty-one isolates were obtained and identified at the species level by phenotypic methods. Sixteen different species were found, pointing to a high degree of specific diversity among *Penicillium* colonizing cork slabs. *P. glabrum* and *P. spinulosum* were the most frequent species. Since both species are closely related and difficult to distinguish by classical systematic analyses, the ribosomal DNA regions ITS1, 5.8S and ITS2 were used as a target to differentiate between them. This molecular approach showed that the isolates previously classified as *P. spinulosum* and *P. glabrum* all belong to the same species *P. glabrum*.

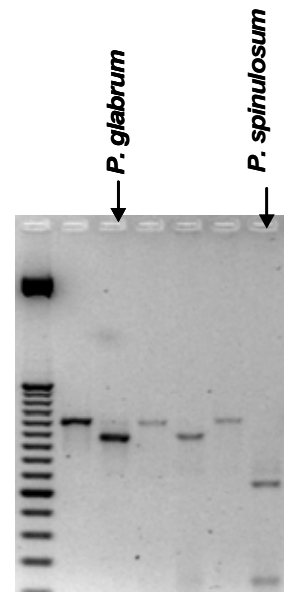
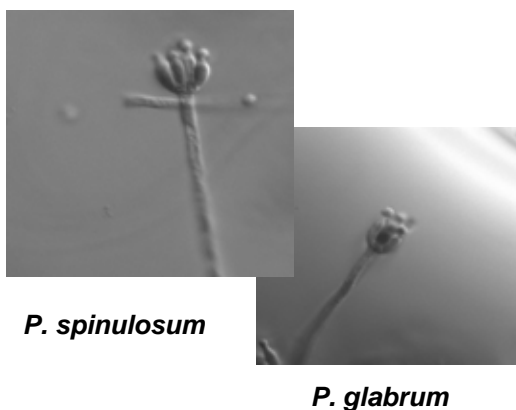

ITS-ARDRA gel showing the different restriction patterns in *P. glabrum* and *P. spinulosum* type strains

Characterization of *Drosophila melanogaster* kinetocore protein profile and identification of α -tubulin interacting proteins*.

Ana Maria Varela Coelho : Mass Spectrometry Laboratory.

The segregation of chromosomes requires linkage between microtubules and the chromosomes. This linkage is established by kinetochores, a structure mainly constituted by proteins that assemble at the centromeric regions of each sister chromatid. Mass spectrometry has increasingly become the method of choice for analysis of complex protein samples, allowing results of primary sequence, post-translational modifications and protein-protein interactions. MS-based proteomics is a discipline made possible by the availability of gene and genome databases and technical and conceptual advances in many areas, most notably the discovery and development of protein ionisation methods.

We have developed a method to obtain an enriched kinetocore fraction. The protein profile pattern of this fraction was characterized after separation by 2D electrophoresis and silver staining. Peptide mass fingerprinting and partial sequencing information was used as a protein identification strategy. Mass spectra were acquired on a MALDI-TOF-TOF type of instrument.

Biomolecular interaction analysis by surface plasma resonance, a biosensor technology that detects binding events between two or more biomolecules, has become one of the most important and versatile approaches to study protein interactions, especially if combined with mass spectrometry. We have used biotinylated tubulin linked to a streptavidin coated Biacore chip to monitor the interactions between tubulin and the proteins of an enriched fraction of *Drosophila* kinetocore. The experimental results suggest the existence of specific interactions with tubulin. Similar conditions were applied to isolate the interacting proteins using streptavidin coated magnetic beads. The isolated proteins were identified by peptide mass fingerprinting.

*A collaboration with A. Tavares. Mitosis Group-IGC

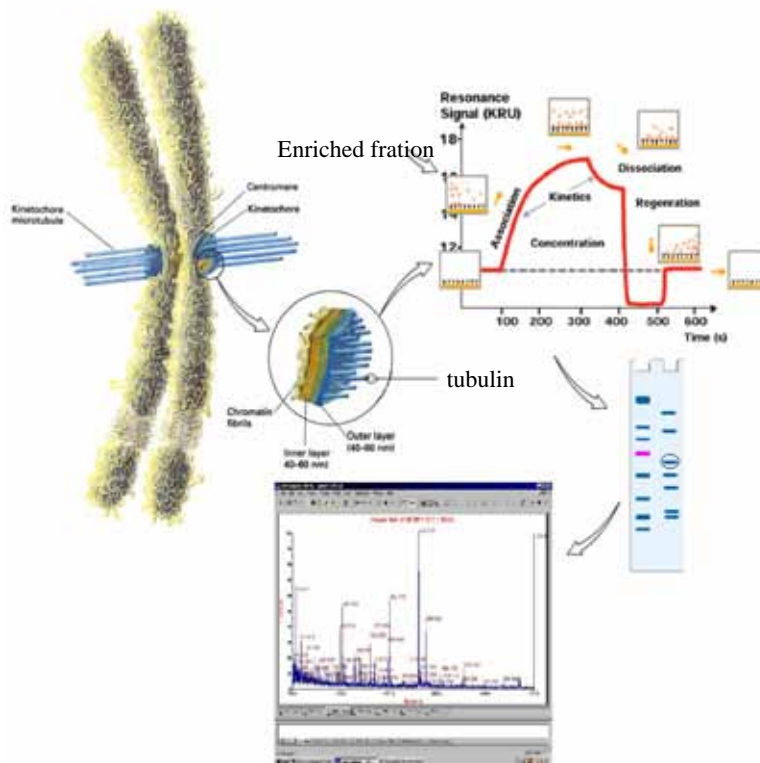

PLANT SCIENCES

PLANT SCIENCES DIVISION: Objectives and Activities.

The Plant Sciences Division now comprises nine laboratories which perform basic research on important problems of plant development and response to stress. Several of the laboratories also carry out research of a more applied nature, in close association with IBET, aiming to solve problems of agronomic or industrial relevance to Portugal in important crops such as, rice, maize, lupin, grapevine, olive tree, almond, pine, cork oak and *Eucalyptus*.

The main activities of the laboratories can be summarized as follows.

Plant Biochemistry I

The biochemistry of developmental processes (seed development, suberization) and of plant responses to stress (drought, mineral deficiency, wounding) continued to be studied in *Lupinus albus*, *Medicago truncatula* and *Quercus suber*. Making use of 2-D electrophoresis and mass spectrometry, a proteomic approach has been pursued. Some relevant proteins thus identified, e.g. proteases, protease inhibitors and dehydrins, associated with drought response, will be studied in relation to their cellular functioning. Protein phosphorylation, a post-translational modification involved in signalling events during early stress responses, will also be studied. By means of ¹³C-NMR the metabolite profile of tissues responding to stress has also been monitored, giving information on the changes in metabolism.

Plant Biochemistry II

This Laboratory focuses on the biotechnology of grapevine for increased resistance to fungal pathogens. Studies include, 1) the expression of the enzymatic components of the ubiquitin/proteasome proteolytic pathway during the interaction grapevine/*U. necator* (powdery mildew agent), 2) the role of grapevine moving particles (GMPs) in plant defence against pathogenic fungi, and 3) two different approaches are being pursued in grapevine transformation experiments; the expression of tissue specific grapevine genes, encoding antifungal proteins, in all grapevine tissues and the expression in all grapevine tissues of a non-grapevine gene encoding a protein with a potent antifungal activity.

Plant Cell Biotechnology

The research aims are, 1) develop the genetic engineering of *Medicago truncatula*, and introduce genes related to drought stress under the control of a constitutive promoter or to analyse the expression of promoters of actinorhizal plant genes involved in plant-actinorhiza interaction, 2) understand the *Pseudomonas savastanoi* – olive tree interaction using a proteomic approach, 3) to develop and apply molecular markers to the characterization, clonal identification and understanding of molecular diversity and molecular structure of grapevine (the Portuguese collection at EVN), of maize (104 inbred lines from the NUMI program), of eucalyptus (212 trees from the breeding program of Celbi) and of olive, 5) to identify functional genes involved in wood synthesis in maritime pine. The objectives for 2005 will include studies of; *Medicago truncatula* transgenic lines harboring genes related to drought tolerance and controlled by stress and ABA responding promoters, a physiological evaluation of the lines already obtained, a study of the association of non-neutral molecular markers with wood quality in maritime pine, a continuation of the use of molecular markers for monitoring *Eucalyptus globulus* genetic diversity of the Celbi genetic improvement program and to certify the improved material, a search for the genes involved in the quality of maize flour to produce “broa”, and a selection of Portuguese landraces for bread making, an improvement of traditional *Lathyrus* varieties and species.

Plant Cell Wall

Results obtained include, 1) the characterisation of the *Medicago* cell wall proteome with respect to wounding (collaborative work with Plant Biochemistry I) has revealed significant homologies with a

variety of wall proteins, 2) several new genes encoding potentially important cell wall proteins involved in wood formation in eucalyptus have been cloned and sequenced, 3) transcriptional studies of the extensin peroxidase gene in grapevine (GvEP) have been completed. Immunolocalisation studies (in collaboration with Prof. José Feijó, IGC) have provided indications of the spatial relation of GvEP with extensin network formation in grapevine. 4) Molecular modeling of an extensin peroxidase and a further peroxidase with minimal reactivity with extensin has revealed potential structural features favouring extensin peroxidase activity.

Plant Developmental Genetics

Work by the PDG group has involved; 1) the continuation of studies on genetic and molecular interactions underlying flower development, 2) transposon-mutagenesis of *DIV*, a gene controlling flower shape (organ growth) in *Antirrhinum*, 3) studies on the roles of *DIV* counterparts in *Arabidopsis* and 4) exploring possibilities for studying *DIV* action by clonal analysis.

Plant Genetic Engineering

Activities have involved, 1) Regeneration/transformation, the establishment of an improved protocol for almond genetic transformation, 2) Organogenesis, several candidate genes putatively involved in *de novo* meristem induction have been identified from microarrays of almond organogenesis SSH libraries (early vs. late organogenesis), 3) Stress resistance, twelve NBS resistance candidate genes have been cloned from almond and analysed phylogenetically; SCAR and CAPS markers associated to *Fusicoccum* tolerance in almond are being developed and tested in 140 individuals from a controlled cross (tolerant x sensitive), 4) Reproduction, six candidate genes of almond flowering have been cloned and characterised, including 3 MADS-box genes, a CONSTANS-like gene, a Gibberellin 20-oxidase gene, a far-red responsive gene and *leafy*, 5) Rice breeding & Markers, three hundred varieties have been characterized for morphological and agronomic traits (height, grain yield, lodging, etc.). Breeding for semi-dwarfism and blast resistance has continued with two breeding schemes and marker assisted backcrossing. Stress responsive transcription factors and vacuolar and plasma membrane Na⁺/H⁺ antiporters have been cloned from rice and inserted into transformation vectors to study tolerance of transgenic rice to abiotic stress.

Plant Molecular Ecophysiology

The main activities comprise the study of physiological mechanisms that govern plant response to water deficits (in particular water acquisition and control of water loss). Under moderate water deficits root-to-shoot chemical signaling in *Vitis vinifera* can lead to significant water saving, whilst maintaining a stable water status and carbon assimilation. Expression of aquaporins (membrane systems that facilitate water transport) is dependent on the environmental conditions and on the genotype. Thermal imaging of individual leaves and canopies was tested under field conditions in order to validate this methodology as a tool to evaluate plant stress *in situ*. This information was related with defence metabolites against excess irradiation, namely leaf xanthophylls. Hydraulic and metabolic components of the resistance to water deficits in roots and leaves of *Eucalyptus globulus* have been studied in two contrasting clones. The objectives for 2005 include; the on-going study of the mechanisms governing plant response to water availability, in particular those related to aquaporins and to proteins with protective function against water deficits (e.g. dehydrins), the study of water uptake patterns for Cork oak and Holm oak in a Montado ecosystem, using stable isotopes, and the study of the chilling effects on the *E. globulus* genotypes earlier characterized for drought resistance.

Plant Cell Biology

The main objective of the research is to help unravel the processes that influence recombinant protein expression, accumulation and stability, and to identify ways of controlling these processes for production. In order to achieve this objective, we intend to pursue two related lines of research; 1) to investigate how transgene expression is influenced by higher-order chromatin structure, for

example to understand how integration and epigenetic modifications influence the expression and stability of transgenes in the host genome; and 2) to study the accumulation of functional recombinant products and how it is influenced by protein processing, transport and deposition in various tissues, physiological states and developmental stages of the plant. The use of transgenes encoding pharmaceutical and feed additive proteins adds an applied dimension to this research (Molecular Farming), which enhances the importance of the fundamental cell biology questions we are addressing.

Pinus Laboratory

An improved procedure for the *Agrobacterium*-mediated transformation of *Pinus pinaster* based on the plant regeneration system through somatic embryogenesis has been established. Transgenic embryogenic tissues and developing somatic embryos expressing marker genes have been obtained and transgenic plant regeneration is underway. The established transformation system is being used as a tool to study the function of genes involved in nitrogen metabolism in collaboration with Prof. F. Cánovas (Univ. Malaga, Spain). Previously identified genes differentially expressed during embryo development are being further characterized by different methods including accurate quantification of expression along development, *in situ* expression localization, protein-GFP fusions and genetic complementation. As a result of the sequencing of a micro-satellite-enriched library of *P. pinaster* in the frame of an International Consortium in which the Group has been involved, new SSR markers have been found. The new, as well as the previously known SSR markers and retrotransposon-based markers (SSAP), are presently being used to investigate genetic stability of pine plants regenerated by somatic embryogenesis.

Highlights from Margarida Rocheta, Philip Jackson and Rita Abranches can be found in the section on the Laboratório Associado.

PLANT SCIENCES DIVISION – STAFF.

Laboratory: Plant Biochemistry (Stress proteins / extracellular proteins)

Head of Laboratory: Cândido Pinto Ricardo

Research team :

Ana Isabel Faria Ribeiro	Ph.D.
Ana Paula Ferreira Regalado	Ph.D.
José António Pires Passarinho	Ph.D.
Carla Maria Alexandre Pinheiro	Ph.D. Student
Inês Maria Silva Almeida Chaves	Ph.D. Student
Ana Sofia Correia Fortunato	Graduate Student
Isabel Tavares Lima Martins	Graduate Student
Rita Maria de Brito Francisco	Graduate Student
Marta Alexandra Marques Alves	Graduate Student

Laboratory: Plant Developmental Genetics

Head of Laboratory: Jorge Almeida

Research team :

Lisete Galego	Ph.D.
---------------	-------

Laboratory : Plant Molecular Ecophysiology

Head of Laboratory: Maria Manuela C. C. F. Chaves

Research team :

Maria Helena Cruz de Carvalho	Post-Doc
Alla Shvaleva	Post-Doc
Olga Grant	Post-Doc
Miguel Costa	Post-Doc
Cláudia Rita de Souza	Ph.D. Student
Elisabete Vieira da Silva	Ph.D. Student
Lukasz Tronina	Ph.D. Student
Alena Torres	Ph.D. Student
Raquel do Vale	Ph.D. Student (ISA/ITQB)
André Pestana	Ph.D. Student (ISA/ITQB)
Ana Rodrigues	Master Student (ITQB/ISA)

Collaborators:

João Santos Pereira	Professor at ISA
Maria Lucília Rodrigues	Investigator at ISA

Laboratory: Plant Cell Biology

Head of Laboratory: Rita Abranches (See also Laboratório Associado Section)

Research Team:

José Alexandre Botelho	Undergraduate Student
Maria João Faria	Undergraduate Student
Mariana Pereira	Undergraduate Student

Laboratory: Plant Genetic Engineering (Gene search and molecular characterization / Plant transformation and improvement)

Head of Laboratory: M. Margarida Oliveira

Research Team :

Ana Maria Beirão Reis Sánchez	Post-Doc
Madalena Cristina Rocha Martins	Post-Doc
Nelson Saibo	Post-Doc
Jayamani Palaniappan	Post-Doc
Maria Helena Raquel Gonçalves	Ph.D. Student
Cristina Maria Neves Silva	Ph.D. Student
Ana Paula Martins Farinha	Ph.D. Student
Ana Margarida Santos	Ph.D. Student
Tiago Lourenço	Ph.D. Student
Sónia Negrão	Ph.D. Student
Rita Batista	Researcher (INSA)/Ph.D. Student
Milene Costa	Researcher
Cátia Pesquita	Undergraduate

Laboratory : Pinus

Coordination of Laboratory : M. Margarida Oliveira / C. Pinto Ricardo

(See Laboratories: “Plant Genetic Engineering” and “Plant Biochemistry”)

Research Team :

Célia Miguel	Post-doc
Margarida Rocheta	Post-doc
Susana Tereso	Ph.D.Student
Sónia Gonçalves	Ph.D.Student
Liliana Marum	Master
Jorge Cordeiro	Graduate
Catarina Estêvão	Graduate
Sandra Carvalho	Graduate

Laboratory : Plant Biotechnology (Plant enzyme purification and characterization / Plant differentiation and molecular characterisation)

Head of Laboratory: Pedro Fevereiro

Research Team:

Carlota Vaz Patto	Post-Doc
Susana Neves	Post-Doc
Vitória João Valente Gemas	Ph.D.Student
Ana Sofia Lopes Duque	Ph.D.Student
Ana Sofia Fernandes Pires	Ph.D.Student
Jorge Almiro Pinto Paiva	Ph.D.Student
Susana de Sousa Araújo	Ph.D.Student
André Almeida	Ph.D.Student
Jingsi Liang	Ph.D.Student
Lúcia do Carmo	Researcher
Leonor Tomaz	Technician

Laboratory: Plant Cell Wall

Head of Laboratory: Philip Jackson (See also Laboratório Associado Section)

Research Team :

Cristina Silva Pereira	Ph.D.Student
José Ribeiro	Ph.D.Student
Nelson Soares	Ph.D.Student
Ada Vatulescu	Ph.D.Student
Sara Vieira da Silva	Ph.D.Student

Laboratory: Plant Biochemistry (Ubiquitin/lectins)

Head of Laboratory: Ricardo B.Ferreira

Research Team :

Sara Monteiro	Post-Doc
Sam Cherian	Post-Doc
Zenjhia Chen	Post-Doc
Maria Cláudia Nunes dos Santos	Ph.D.Student
Ana Sofia Sénica Caeiro	Ph.D.Student
Cristina Branco Price	Ph.D.Student
Mariana Boavida Carvalho	Ph.D.Student
Regina Luz Freitas	Ph.D.Student
António Jorge Oliveira	Undergraduate Student
Patrícia Teles Martins	Undergraduate Student

Lupinus albus Stem as a Survival Structure to Drought: Metabolic and Proteomic Profile.

Cândido Pinto Ricardo : Plant Biochemistry Laboratory.

White lupin (*Lupinus albus*) is a valuable legume crop that can withstand severe water deficit (WD). Plants submitted to WD lose the bulk of their leaves, whilst the stem and the roots play a crucial role in survival. The roots lose water more rapidly than the stem which acts as a preferential storage organ. At severe stress, the stem, particularly its stele, has a strong storage function for sugars and amino acids (1) and to a lesser extent to soluble proteins.

The proteins of the two stem components, cortex and stele, were fractionated according to protein solubility in different solutions, separated by two-dimensional electrophoresis (2DE; fig. 1) and identified by tandem mass spectrometry. To visualise the proteins of the HEPES fraction properly it was necessary to use narrow pH gradients (fig. 2). 2DE patterns of the stem stele and cortex are very similar (2). The changes in protein expression start to be noticeable at 3 days after withholding water, when the plant water status is still unaffected, but at more severe stress a larger number of stem proteins are affected. Immunofilin, serine protease and cysteine protease (well known components in animal sensing pathways) are some of these proteins. Interestingly in both stele and cortex, the simultaneous expression of proteases and protease inhibitors is observed, and these react differently to the stress level and to rewatering. Rewatering does not cause *de novo* expression of proteins, although the level of the protease inhibitors is significantly raised. The minute number of sequence matches with known protein or EST databases, is an indication that the stem metabolism is essentially unknown and needs to be deeply investigated.

(1) Pinheiro C., Passarinho J.A., and Ricardo C.P. 2004. Effect of drought and rewatering on the metabolism of *L. albus* organs. *Journal of Plant Physiology*, 161, 1203-1210.

(2) Pinheiro C., Kehr J. and Ricardo C.P. Effect of water stress on lupin stem protein analysed by two-dimensional gel electrophoresis. *Planta* (in press).

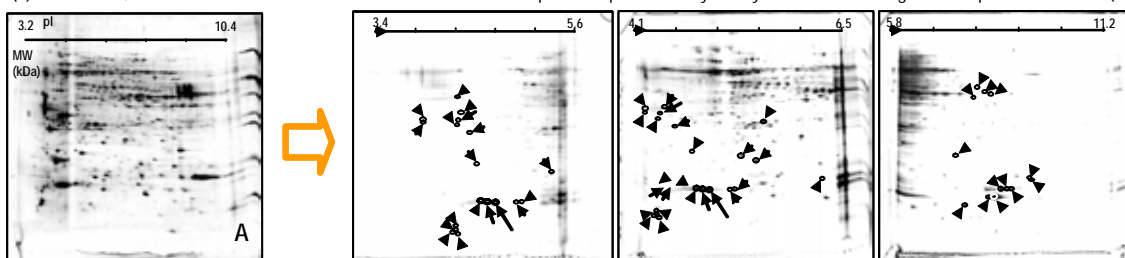

Fig. 2 – Separation of the stem stele proteins soluble in 50 mM HEPES with narrowed pH intervals. Arrows represent the selected proteins for MS characterisation.

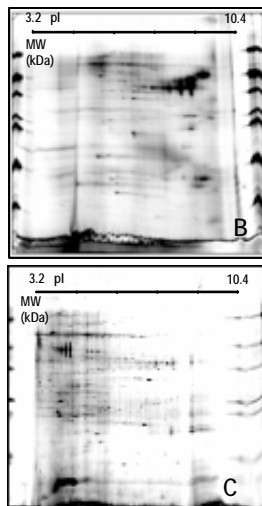
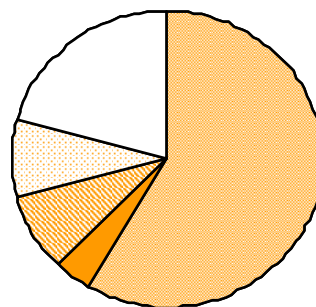

Fig. 1 – Separation of the stem stele proteins: A – soluble in 50 mM HEPES; B - soluble in 1.5 M NaCl; C – solubilised by 8 M urea.

WD responsive polypeptides



- unknown
- PR proteins
- regulatory proteins
- proteases
- protease inhibitors

Transposon-mutagenesis at the *DIVARICATA* locus in *Antirrhinum*.

L. Galego and J. Almeida: Plant Developmental Genetics Laboratory.

The shapes of floral organs depend on genes that act asymmetrically in relation to a dorsoventral axis of flowers. In *Antirrhinum*, one such gene, *DIVARICATA* (*DIV*), controls petal shape through an effect on growth. As observed in *div* loss-of-function mutants, this effect is restricted to a ventrolateral domain of the flower corolla (fig.1).

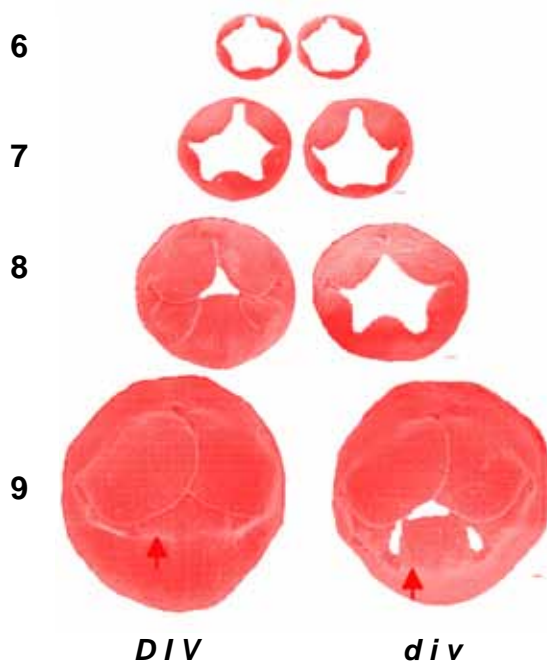

Figure 1. Corolla development in wild type (*DIV*) and in *div* mutant plants. Numbers on the left are standardized stages of flower development. For each bud, two dorsal (top) and one ventral and two lateral petals (bottom) can be recognized.

How is the domain of *DIV* activity specified? One approach to this problem is to analyse how *DIV* interacts with other determinants of the dorsoventral pattern. This has shown that two genes, *CYC* and *DICH*, inhibit *DIV* activity in dorsal regions of the flower. A complementary approach involves searching for mutations in *DIV* that might alter the way it interacts with other genes. This requires a strategy

for generating mutations specifically in *DIV* with a relatively high frequency. One such strategy, available in *Antirrhinum*, exploits the properties of endogenous transposable elements combined with the use of a reverse genetic approach to select for transposon-induced events in a site-specific manner.

Using this strategy, we identified an insertion of the transposon Tam3 in the 5'UTR of *DIV*, conferring a very weak mutant phenotype (allele *div-3*, fig.2). Tam3 has the property of frequently generating further mutations in the vicinity of its insertion sites. These include: (i) deletions or rearrangements of a few to thousands of bp adjacent to the insertion site, resulting from imprecise or abortive transposon excision and (ii) novel insertions resulting from short-range transposition. An additional property of Tam3 is that the frequency of its movement can be controlled by temperature. By taking advantage of these properties, a null *div* mutant carrying a deletion of the entire gene was selected for in the progeny of *div-3* plants.

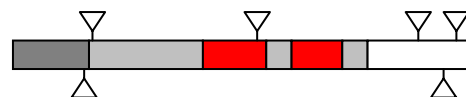

Figure 2. Structures of *DIV* alleles. Transcribed, non-translated sequences and exons are shown in pale gray and red respectively (transcription is from left to right). Triangles represent the transposon Tam3 in one orientation (above) or its opposite (below).

Novel Tam3 insertions were also identified upstream or downstream of the *DIV* transcription unit and in the *DIV* coding region (fig.2). These provide a range of positions around which further sequence variation can now be produced.

Plasma Membrane Aquaporins in Grapevine Berries.

Manuela Chaves: Plant Molecular Ecophysiology Laboratory.

During the last decade, it became evident that water movement across biological membranes may be facilitated by special proteins behaving as water channels, the aquaporins. They belong to a highly conserved group of membranes proteins, the major intrinsic proteins (MIPs). In grapevine we investigated aquaporins in the berries, because of their impact in turgor and indirectly in sugar concentration at harvest. We isolated cDNA from berries of *Vitis vinifera* cv Moscatel and Castelão that shows high homology with the PIP1 (plasma membrane intrinsic protein 1) subfamily. For VvPIP1a cv Moscatel, the structure was derived by homology modelling from three known X-ray structures (Fig1). This structure has one Histidine residue in the intracellular loop D, at the same position as His197 in PIP2-2 from Arabidopsis, which suggests a role for pH in aquaporin gating in grapevine berries. This may be of importance during berry maturation.

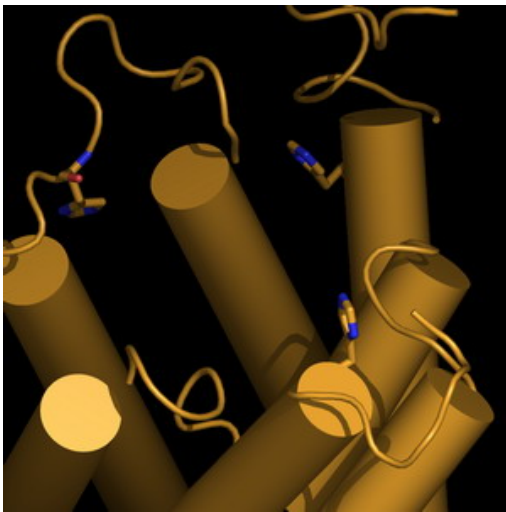

Fig.1: PIP1 structure from grapevine berry, derived by homology modeling (collaboration with C.Soares)

Studies of aquaporin expression indicate a dependence on the environmental conditions and on the cultivar. In cv Castelão a higher water deficit (NI and PRD) led to increased expression of VvPIP (Fig 2).

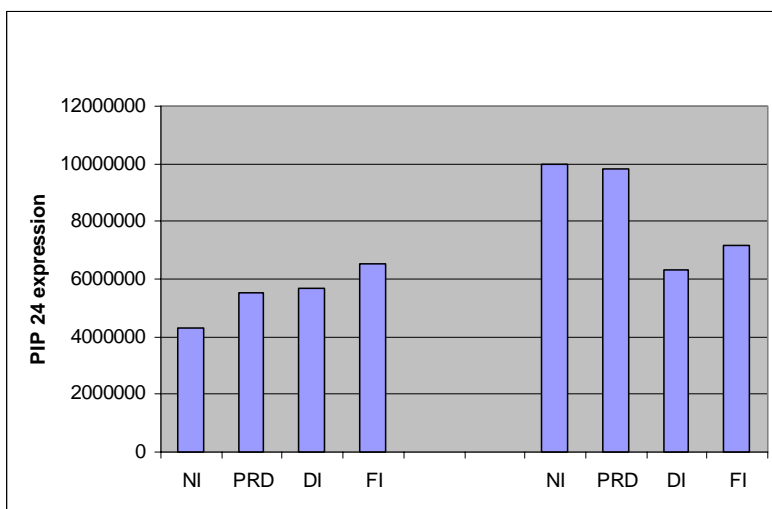

Fig 2: Expression of Vv PIP in cultivars Moscatel and Castelão subjected to different watering treatments: NI- non-irrigated; PRD- partial root drying, with vines receiving 50% of Etc in alternate rows; DI- vines receiving 50% of Etc; FI- vines receiving 100% of Etc

Development of a Marker-Assisted Selection System Associated to *Fusicoccum* Tolerance/Sensitivity in Almond.

M. Margarida Oliveira: Plant Genetic Engineering Laboratory.

Molecular markers linked to *Fusicoccum* tolerance/sensitivity in almond (*Prunus dulcis* Mill.) were developed for marker-assisted selection. Almond is a culture particularly spread and well adapted to the whole Mediterranean region, accounting for 28% of the world production. However, the sensibility of this culture, particularly to certain fungal diseases such as *Fusicoccum* canker or constriction canker, can lead to significant economic losses due to severe decrease of almond production. Constrictions formed at the base of infected shoots and leaf symptoms produced well beyond the infection site result from a translocable toxin, fusicoccin (Fig. 2a). This toxin obliges the stomata to remain open, leading to water loss and drying of the branches (Fig. 2) and eventually causing the death of the whole tree.

In our study the RAPD technique was combined with bulked DNA analysis to select markers associated to either tolerance or sensitivity to *Fusicoccum* in almond. Fourteen almond cultivars classified as tolerant (7) or sensitive (7) to *Fusicoccum* were screened with 120 RAPD primers. These plants were obtained from IRTA Mas Bové (Spain) where their phenotypic behaviour towards *Fusicoccum* was characterised under field conditions. Polymorphic bands were assessed for co-segregation with tolerant or susceptible phenotypes using seedlings obtained from tolerant x sensitive crosses. Three RAPD markers were identified, two linked to tolerance (OPD-19_{Tol300} and OPA-08_{Tol900}) and one linked to sensitivity (OPD-19_{Sen500}) to *Fusicoccum*.

The identification of molecular markers linked to tolerance or sensibility to *Fusicoccum* is of particular importance, since this is the only method that will allow the early selection of tolerant almond plants in breeding programs as well as the certification of tolerant cultivars to be used in the establishment of new orchards.

The development of more reliable markers (transferable across different backgrounds) associated to *Fusicoccum* disease in almond is presently going on (SCAR markers are being tested and CAPS markers are being developed). This type of markers will allow the improvement of the certification system for future application in routine analyses.

Fig. 1 – Development of molecular markers associated to tolerance/sensitivity to *Fusicoccum* canker in almond. Screening of fourteen almond cultivars, tolerant (7) or sensitive (7), with 120 RAPD primers. A – “Bulked DNA analysis”; B – Screening of each individual; RAPD markers linked to tolerance/sensitivity to *Fusicoccum*

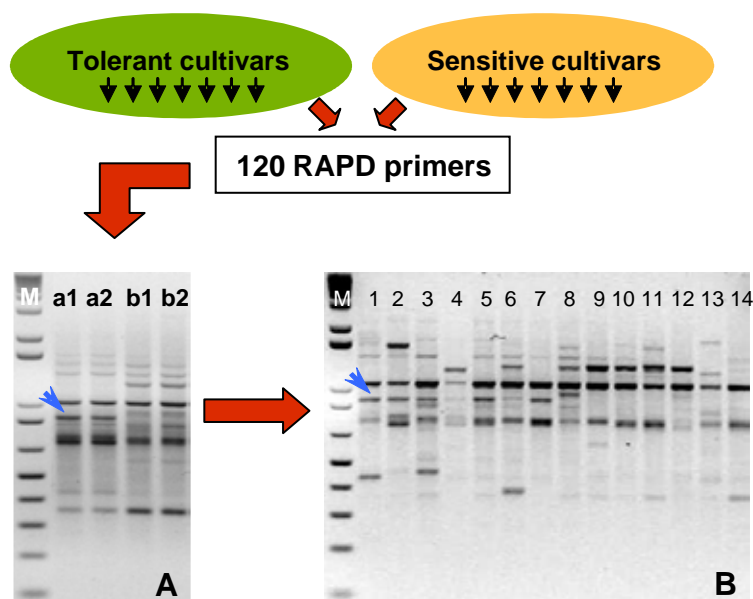

Fig. 2 - Infected twig and shoots with sunken cankers on almond trees.

Three RAPD markers identified, associated to tolerance/sensitivity to *Fusicoccum* in almond:

- OPD-19_{Tol300}
- OPA-08_{Tol900}
- OPD-19_{Sen300}

C

Genetic transformation of maritime pine.

M. Margarida & C. Pinto Ricardo : Coordinators, Pinus Laboratory.

An efficient procedure for the genetic transformation of maritime pine (*Pinus pinaster*) embryogenic tissues using a disarmed strain of *Agrobacterium tumefaciens* has been established. *Agrobacterium*-mediated transformation of plant tissues is based on the ability of this soil bacterium to transfer a particular T-DNA segment from a tumor-inducing (Ti) plasmid to the genome of the plant target cell. The development of the genetic transformation system here described is based on the *in vitro* regeneration method known as somatic embryogenesis (see 2003/4 report). When associated with conventional breeding, genetic transformation may provide a powerful tool for rapidly increasing yield, wood quality or adaptability of maritime pine. Furthermore, this is an extremely useful tool to test gene function in basic gene characterization studies. The main goal of this work was the development of a transformation procedure to be used in the functional characterization of genes involved in nitrogen metabolism.

The established procedure involves the infection of embryogenic cell suspensions with *Agrobacterium* suspensions in a 1:1 proportion followed by plating the resulting mixture onto a filter paper placed on adequate culture medium. The effect of casein hydrolysate in the culture medium during co-cultivation with *Agrobacterium* and subsequent subculture was tested, showing that its absence was determinant for the control of *Agrobacterium* growth. The most important factors for the success of transformation of this species are the control of *Agrobacterium* growth, the genotype and the physiological state of the embryogenic tissues. Hygromycin was found to be an efficient selective agent of *Pinus pinaster* transformed tissues. Transfer, integration and expression of marker genes in embryogenic pine tissues were successfully achieved. The transformed embryogenic cultures are presently under culture for the production of mature somatic embryos and subsequent plant regeneration. These have the potential to produce a large number of transgenic plantlets, which can then be multiplied. These procedures are being used to transform pine embryogenic cultures with genes involved in nitrogen metabolism for subsequent gene functional analysis in regenerated transgenic plants.

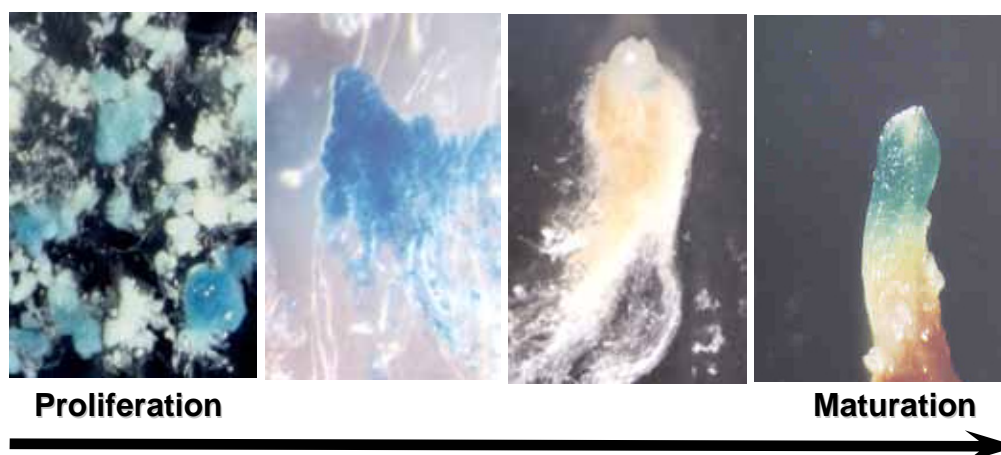

*Histochemical assay showing expression (blue staining) of the β -glucuronidase gene (*uidA*) introduced in embryogenic tissues of maritime pine via *Agrobacterium*-mediated transformation. Expression is found in proliferating embryogenic tissues and throughout the maturation process of the somatic embryos.*

Transformation of *Medicago truncatula* for Drought stress Tolerance.

Pedro Fevereiro: Plant Biotechnology Laboratory.

Legumes are a large family of plants that, because of their capacity to fix atmospheric nitrogen, are essential components of terrestrial ecosystems and a source of food, feed, forage and other compounds with industrial and commercial uses. Understanding their biological questions and the molecular basis of nitrogen fixation is important and led to the development of legume experimental model systems. *M. truncatula* is a diploid ($2n=16$), autogamous species with a relatively small genome (1.8×10^9 bp - Jemalong cultivar) and short life cycle of about 3 months. These characteristics enable this species to be used in molecular genetic studies like analysis of gene expression, promoter functional analysis, TDNA mutagenesis and expression of genes for crop improvement. We developed a successful regeneration–transformation method with a new highly embryogenic genotype of *M. truncatula* cv Jemalong. Transformation was done with *Agrobacterium tumefaciens* carrying either plasmid p35S*Adc*–*Gus* or plasmid p35S*Dsp22*. *Adc* codes for an enzyme (oat arginine decarboxylase) of the biochemical pathway of polyamines that are involved in the response to water stress. *Dsp22* codes for a thylacoidal protein expressed in *Craterostigma plantagineum* (a resurrection plant), responding to water stress and ABA. Our aim is to contribute to the development of a strategy to improve legumes against drought stress through genetic engineering.

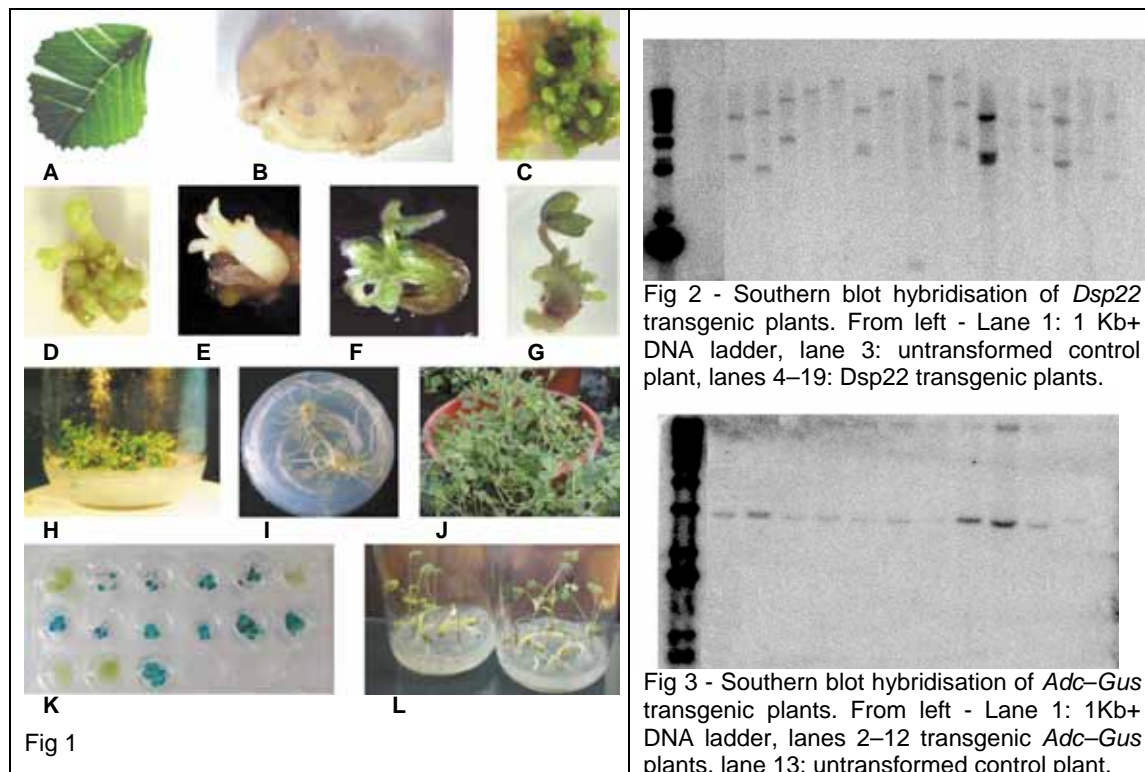
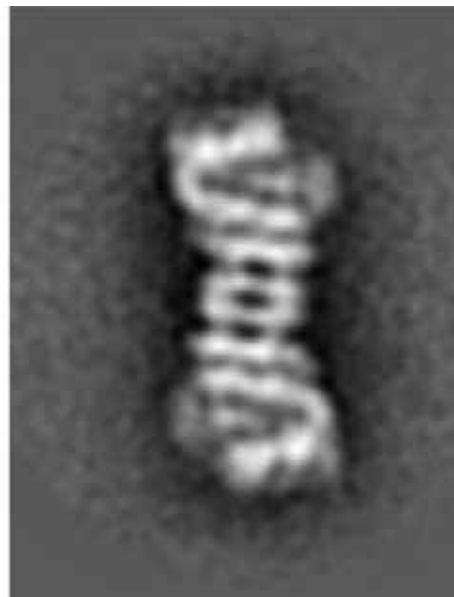

Fig 1 - Transformation-regeneration in *M. truncatula* cv. Jemalong M9–10a genotype. (A) Wounded leaflet; (B) Embryogenic *callus* originated from non-infected leaflet in selective conditions. No somatic embryos developed; (C) Embryogenic *callus* derived from a non-infected leaflet in induction medium; (D) KanR clump of somatic embryos at different stages of development; (E) KanS embryo (bleached); (F) KanR embryo conversion; (G) Hyperhydric shoot in gelrite-containing medium. Note the occurrence of secondary embryogenesis; (H) KanR plantlets; (I) Transgenic T0 line rooted in 50mg l⁻¹ of kanamycin; (J) T0 transgenic lines flowering in the greenhouse; (K) Histochemical *Gus* assay: positive (blue staining) and negative (bleached) results in leaves, roots and stems of putative *Adc*–*Gus* transgenic plants. Untransformed M9–10a used as negative control (bleached leaves, first well); (L) T1 seedlings segregating in 400mg l⁻¹ kanamycin-containing medium. KanR seedlings present green leaves; KanS seedlings present bleached leaves.

26 S Proteasome from *Lemna Minor*.

Ricardo Boavida Ferreira: Plant Biochemistry Laboratory II.

The ubiquitin/proteasome proteolytic pathway plays a fundamental role in the protein metabolism of eukaryotic cells. A self-compartmentalized, ATP-dependent protease, the 26 S proteasome, is ultimately responsible for the hydrolysis of the protein substrates to small peptides. This very large protease has been extensively purified and characterized from *Lemna minor* cells. The electron micrograph shown below illustrates its subunit composition, identical to that observed for the enzyme from animal species.



As demonstrated for the animal 26 S proteasome, the protease is composed of a 20 S core protease (CP), in which proteins are degraded to short peptides, and two 19 S regulatory particles (RP), which confer ATP-dependence and substrate specificity. The CP is a broad spectrum ATP- and ubiquitin-independent peptidase created by the assembly of four, stacked heptameric rings of related α and β subunits surrounding a central cavity. Its two inner rings form a central chamber containing the proteolytic sites, which face the central cavity. Access to this chamber is restricted by a narrow gated channel created by the α -subunit rings, which is normally maintained in the closed state. Even in its open state, controlled by the ATPases in the RP, it allows entry of only unfolded proteins. Each end of the CP is capped by a RP. Apparently, the RP recognizes and binds to polyubiquitylated proteins, releases the attached ubiquitins as free monomers, unfolds the protein substrates, opens the α -subunit ring gate and directs the unfolded proteins into the CP lumen for degradation. In this way, ubiquitin conjugation, the proteasome architecture and their linkage to ATP hydrolysis ensure that only unwanted proteins are selectively degraded.

**RESEARCH
OUTPUT**

RESEARCH OUTPUT

PUBLICATIONS and PATENTS

Publications are organized by Research Divisions and the Laboratório Associado. The total number of publications of the ITQB researchers in 2004 on peer reviewed scientific journals was 128¹. In the lists below, some papers may be duplicated among the Research Divisions since they have contributions from researchers from more than one Division.

¹ The papers dated 2005 (published or in press) are not counted in the overall figure of 128

LABORATÓRIO ASSOCIADO

ISI Publications

2004

1. Gaspar P, Neves AR, Ramos A, Gasson MJ, Shearman CA, Santos H; Engineering *Lactococcus lactis* for production of mannitol: High yields from food-grade strains deficient in lactate dehydrogenase and the mannitol transport system; APPLIED AND ENVIRONMENTAL MICROBIOLOGY, 70 (3): 1466-1474 MAR 2004.
2. Pessanha M, Londer YY, Long WC, Erickson J, Pokkuluri PR, Schiffer M, Salgueiro CA; Redox characterization of *Geobacter sulfurreducens* cytochrome c_7 : Physiological relevance of the conserved residue F15 probed by site-specific mutagenesis; BIOCHEMISTRY, 43 (30): 9909-9917 AUG 3 2004.
3. Teixeira VH, Baptista AM, Soares CM; Modeling electron transfer thermodynamics in protein complexes: Interaction between two cytochromes c_3 ; BIOPHYSICAL JOURNAL, 86 (5): 2773-2785 MAY 2004.
4. Victor BL, Baptista AM, Soares CM; Theoretical identification of proton channels in the quinol oxidase aa_3 from *Acidianus ambivalens*; BIOPHYSICAL JOURNAL, 87 (6): 4316-4325 DEC 2004.
5. Cunha AE, Clemente JJ, Gomes R, Pinto F, Thomaz M, Miranda S, Pinto R, Moosmayer D, Donner P, Carrondo MJT; Methanol induction optimization for scFv antibody fragment production in *Pichia pastoris*; BIOTECHNOLOGY AND BIOENGINEERING, 86 (4): 458-467 MAY 20 2004.
6. Royo B, Herdtweck E, Romão CC; Synthesis and structural characterization of novel oxorhenium(V) complexes containing N-heterocyclic carbenes; EUROPEAN JOURNAL OF INORGANIC CHEMISTRY, (16): 3305-3309 AUG 20 2004.
7. Yamashita K, McDaid J, Ollinger R, Tsui TY, Berberat PO, Usheva A, Csizmadia E, Smith RN, Soares MP, Bach FH; Biliverdin a natural product of heme catabolism induces tolerance to cardiac allografts; FASEB JOURNAL 18 (2): FEB 2004.
8. Akamatsu Y, Haga M, Tyagi S, Yamashita K, Graca-Souza AV, Ollinger R, Czismadia E, May GA, Ifedigbo E, Otterbein LE, Bach FH, Soares MP; Heme oxygenase-1-derived carbon monoxide protects hearts from transplant-associated ischemia reperfusion injury; FASEB JOURNAL 18 (2): FEB 2004.
9. Louro RO, Catarino T, Paquete CM, Turner DL; Distance dependence of interactions between charged centres in proteins with common structural features; FEBS LETTERS, 576 (1-2): 77-80 OCT 8 2004.
10. Pessanha M, Rothery EL, Louro RO, Turner DL, Miles CS, Reid GA, Chapman SK, Xavier AV, Salgueiro CA; Redox behaviour of the haem domain of flavocytochrome c_3 from *Shewanella frigidimarina* probed by NMR; FEBS LETTERS, 578 (1-2): 185-190 DEC 3 2004.
11. Marinho CR, Bucci DZ, Dagli ML, Bastos KR, Grisotto MG, Sardinha LR, Baptista CR, Penha-Goncalves C, Lima MR, Alvarez JM; Pathology affects different organs in two mouse strains chronically infected by a *Trypanosoma cruzi* clone: a model for genetic studies of Chagas' disease; INFECTION AND IMMUNITY 72 (4): 2350-2357 APR 2004.
12. Leon K, Faro J, Lage A, Carneiro J; Inverse correlation between the incidences of autoimmune disease and infection predicted by a model of T cell mediated tolerance; JOURNAL OF AUTOIMMUNITY 22 (1): 31-42 FEB 2004.
13. Gardete S, Ludovice AM, Sobral RG, Filipe SR, de Lencastre H, Tomasz A; Role of *murE* in the expression of beta-lactam antibiotic resistance in *Staphylococcus aureus*; JOURNAL OF BACTERIOLOGY, 186 (6): 1705-1713 MAR 2004.
14. Correia IJ, Paquete CM, Coelho A, Almeida CC, Catarino T, Louro RO, Frazao C, Saraiva LM, Carrondo MA, Turner DL, Xavier AV; Proton-assisted two-electron transfer in natural variants of tetraheme cytochromes from *Desulfomicrobium sp.*; JOURNAL OF BIOLOGICAL CHEMISTRY, 279 (50): 52227-52237 DEC 10 2004.

15. Soares CM, Baptista AM, Pereira MM, Teixeira M; Investigation of protonatable residues in *Rhodothermus marinus caa₃* haem-copper oxygen reductase: comparison with *Paracoccus denitrificans caa₃* haem-copper oxygen reductase; JOURNAL OF BIOLOGICAL INORGANIC CHEMISTRY, 9 (2): 124-134 MAR 2004.
16. Maranga L, Cunha A, Clemente J, Cruz P, Carrondo MJT; Scale-up of virus-like particles production: effects of sparging, agitation and bioreactor scale on cell growth, infection kinetics and productivity; JOURNAL OF BIOTECHNOLOGY, 107 (1): 55-64 JAN 8 2004.
17. Soares MP, Seldon MP, Gregoire IP, Vassilevskaia T, Berberat PO, Yu J, Tsui TY, Bach FH; Heme oxygenase-1 modulates the expression of adhesion molecules associated with endothelial cell activation; JOURNAL OF IMMUNOLOGY 172 (6): 3553-3563 MAR 15 2004.
18. Leon K, Faro J, Carneiro J; A general mathematical framework to model generation structure in a population of asynchronously dividing cells; JOURNAL OF THEORETICAL BIOLOGY 229 (4): 455-476 AUG 21 2004.
19. Carmo M, Peixoto C, Coroadinha AS, Alves PM, Cruz PE, Carrondo MJT; Quantitation of MLV-based retroviral vectors using real-time RT-PCR; JOURNAL OF VIROLOGICAL METHODS, 119 (2): 115-119 AUG 2004.
20. Mato R, Campanile F, Stefani S, Crisostomo MI, Santagati M, Sanches IS, De Lencastre H; Clonal types and multidrug resistance patterns of methicillin-resistant *Staphylococcus aureus* (MRSA) recovered in Italy during the 1990s; MICROBIAL DRUG RESISTANCE-MECHANISMS EPIDEMIOLOGY AND DISEASE, 10 (2): 106-113 SUM 2004.
21. Ramos A, Neves AR, Ventura R, Maycock C, Lopez P, Santos H; Effect of pyruvate kinase overproduction on glucose metabolism of *Lactococcus lactis*; MICROBIOLOGY-SGM, 150: 1103-1111 PART 4 APR 2004.
22. Almeida P, Penha-Goncalves C; Long perfect dinucleotide repeats are typical of vertebrates, show motif preferences and size convergence; MOLECULAR BIOLOGY AND EVOLUTION 21 (7): 1226-1233 JUL 2004.
23. Marinho CRF, Bucci DZ, Dagli MLZ, Bastos KRB, Grisotto MG, Sardinha LR, Baptista CRGM, Goncalves CP, Lima MRD, Alvarez JM; Pathology affects different organs in two mouse strains chronically infected by a *Trypanosoma cruzi* clone: a model for genetic studies of Chagas' disease; INFECTION AND IMMUNITY 72 (4): 2350-2357 APR 2004.
24. Sherratt DJ, Soballe B, Barre FX, Filipe S, Lau I, Massey T, Yates J; Recombination and chromosome segregation; PHILOSOPHICAL TRANSACTIONS OF THE ROYAL SOCIETY OF LONDON SERIES B-BIOLOGICAL SCIENCES, 359 (1441): 61-69 JAN 29 2004.
25. Vatulescu AD, Fortunato AS, Sa MC, Amancio S, Ricardo CPP, Jackson PA; Cloning and characterization of a basic IAA oxidase associated with root induction in *Vitis vinifera*; PLANT PHYSIOLOGY AND BIOCHEMISTRY, 42 (7-8): 609-615 JUL-AUG 2004.
26. Godinho SSMC, Royo B, Lobato MT, Herdtweck E, Romão CC; Synthesis and structure of diphenylphosphine derivatives of molybdenocene; POLYHEDRON, 23 (7): 1263-1270 APR 15 2004.
27. Pokkuluri PR, Londer YY, Duke NEC, Erickson J, Pessanha M, Salgueiro CA, Schiffer M; Structure of a novel c₇-type three-heme cytochrome domain from a multidomain cytochrome c polymer; PROTEIN SCIENCE, 13 (6): 1684-1692 JUN 2004.
28. Eberini I, Baptista AM, Gianazza E, Fraternali F, Beringhelli T; Reorganization in apo- and holo-beta-lactoglobulin upon protonation of Glu89: Molecular dynamics and pK_a calculations; PROTEINS-STRUCTURE FUNCTION AND BIOINFORMATICS, 54 (4): 744-758 MAR 1 2004.
29. Bento I, Matias PM, Baptista AM, da Costa PN, van Dongen WMAM, Saraiva LM, Schneider TR, Soares CM, Carrondo MA; Molecular basis for redox-Bohr and cooperative effects in cytochrome c₃ from *Desulfovibrio desulfuricans* ATCC 27774: Crystallographic and modeling studies of oxidized and reduced high-resolution structures at pH 7.6; PROTEINS-STRUCTURE FUNCTION AND GENETICS, 54 (1): 135-152 JAN 1 2004.

2005

1. Rodrigues ML Bonifácio MJ Soares-da-Silva P Carrondo MA Archer M; Crystallization and preliminary X-ray diffraction studies of catechol-O-methyltransferase/inhibitor complex; ACTA CRYSTALLOGRAPHICA F61 118-120 2005.
2. Fernandes AC Fernandes R Romão CC Royo B; [MoO₂Cl₂] as catalyst for hydrosilylation of aldehydes and ketones; CHEMICAL COMMUNICATIONS (2): 213-214 2005.
3. McDaid J, Yamashita K, Chora A, Ollinger R, Strom TB, Li XC, Bach FH, Soares MP; Heme oxygenase-1 modulates the allo-immune response by promoting activation-induced cell death of T cells; FASEB JOURNAL 19 (1): JAN 2005.
4. Camara NOS, Soares MP; Heme oxygenase-1 (HO-1) a protective gene that prevents chronic graft dysfunction; FREE RADICAL BIOLOGY AND MEDICINE 38 (4): 426-435 FEB 15 2005.
5. Oliveira R Clemente JJ Cunha AE Carrondo MJT; Adaptive dissolved oxygen control through the glycerol feeding in a recombinant *Pichia pastoris* cultivation in conditions of oxygen transfer limitation; JOURNAL OF BIOTECHNOLOGY 116 (1): 35-50 MAR 2 2005.
6. Simplício AL Gilmer JF Frankish N Sheridan H Walsh JJ Clancy JM; Ionisation characteristics and elimination rates of some aminoindanones determined by capillary electrophoresis; JOURNAL OF CHROMATOGRAPHY 1054 233-38 JAN 2005.
7. Santos SS Fonseca LL Monteiro MAR Carrondo MJT Alves PM; Culturing primary brain astrocytes under a fully controlled environment in a novel bioreactor; JOURNAL OF NEUROSCIENCE RESEARCH 79 (1-2): 26-32 JAN 1 2005.
8. Moraes F, Novoa A, Jerome-Majewska LA, Papaioannou VE, Mallo M; Tbx1 is required for proper neural crest migration and to stabilize spatial patterns during middle and inner ear development; MECHANISMS OF DEVELOPMENT 122 (2): 199-212 FEB 2005.

In Press

1. Gilmer JF Simplício AL Clancy JM; A new amino-masking group capable of pH-triggered amino-drug release; EUROPEAN JOURNAL OF PHARMACEUTICAL SCIENCES.
2. Ferreira TB Alves PM Aunins JG Carrondo MJT; Use of adenoviral vectors as veterinary vaccines; GENE THERAPY.
3. Campino S Bagot S Bergman ML Almeida P Sepúlveda N Pied S Penha-Gonçalves Holmberg D Cazenave PA; Genetic control of parasite clearance leads to resistance to *P. berghei* ANKA infection and confers immunity; GENES AND IMMUNITY.
4. Fonseca LL Monteiro MAR Alves PM Carrondo MJT Santos H; Cultures of rat astrocytes challenged with a steady supply of glutamate: a new model to study flux distribution in the glutamate-glutamine cycle; GLIA .
5. Lopes MFS Simões AP Tenreiro R Marques JJF Barreto Crespo MT; Activity and expression of a virulence factor gelatinase in dairy *enterococci*; INTERNATIONAL JOURNAL OF FOOD MICROBIOLOGY.
6. Ribeiro T Abrantes M Lopes MFS Tenreiro R Barreto Crespo MT; Vancomycin resistance in dairy and clinical enterococcal isolates from Portugal: proof of dissemination of Tn1546; INTERNATIONAL JOURNAL OF FOOD MICROBIOLOGY.
7. Nunes S Sá –Leão R Carriço J Alves C R Mato R Brito-Avô A Saldanha J Almeida JS Santos Sanches I de Lencastre H; Trends in drug resistance serotypes and molecular types of *Streptococcus pneumoniae* colonizing pre-school age children attending day care centers in Lisbon Portugal – a summary of four years of annual surveillance; JOURNAL OF CLINICAL BIOLOGY.
8. Abranches R Marcel S Arcalis E Fevereiro P Stoger E; Plants as bioreactors: Evaluation of *Medicago truncatula* as an emerging production system; JOURNAL OF BIOTECHNOLOGY.
9. Souza APB Carvalho AV Peixoto CC Maranga L Moraes RHP Mendonça RZM Pereira CA Carrondo MJT Mendonça RZ; Purification and characterization of an anti-apoptotic protein isolated from *Lonomia obliqua* hemolymph; JOURNAL OF BIOTECHNOLOGY.

10. Carneiro J Paixão T Milutinovic D Sousa J Leon K Gardner R Faro J; Immunological Self-Tolerance: Lessons from Mathematical Modeling; JOURNAL OF COMPUTATIONAL AND APPLIED MATHEMATICS.
11. Boucontet L Sepúlveda N Carneiro J Pereira P; Mechanisms controlling termination of V-J recombination at the TCR- γ locus: Implications for allelic and isotypic exclusion of TCR- γ chains; JOURNAL OF IMMUNOLOGY.
12. Sepúlveda N Boucontet L Pereira P Carneiro J; Stochastic modeling of T cell receptor γ gene rearrangement; JOURNAL OF THEORETICAL BIOLOGY.
13. Guevara MA Changn D Almeida MH Byrne M Collada C Favre JM Harvengt L Jeandroz S Orazio C Plomion C Ramboer A Rocheta M Sebastiani F Soto A Vendramin G Gand-Cervera MT; Isolation and characterization of nuclear microsatellite loci in *Pinus pinaster* Ait; MOLECULAR ECOLOGY NOTES.
14. Frazão N Brito-Avô A Simas C Saldanha J Mato R Nunes S Sousa NG Carriço J Almeida J Santos-Sanches I de Lencastre H; Effect of the 7-valent conjugate pneumococcal vaccine on carriage and drug resistance of *Streptococcus pneumoniae* in healthy children attending day-care centers in Lisbon; PEDIATRIC AND INFECTIOUS DISEASES.
15. PeixotoCC Marcelino I Sousa MQ Vachiéry N Bensaid A Martinez D Carrondo MJT Alves PM; Quantification of *Ehrlichia ruminantium* by Real Time PCR; VETERINARY MICROBIOLOGY.
16. Filipe SR, Tomasz A, Ligoxygakis P; Requirements of peptidoglycan structure allowing detection by the *Drosophila* Toll pathway; EMBO Reports.

CHEMISTRY DIVISION

ISI Publications

2004

1. Matos C, Lima JLC, Reis S, Lopes A, Bastos M; Interaction of antiinflammatory drugs with EPC liposomes: Calorimetric study in a broad concentration range; BIOPHYSICAL JOURNAL, 86 (2): 946-954 FEB 2004.
2. Rauter AP, Piedade F, Almeida T, Ramalho R, Ferreira MJ, Resende R, Amado J, Pereira H, Justino J, Neves A, Silva FVM, Canda T; Sugar bislactones by one-step oxidative dimerisation with pyridinium chlorochromate versus regioselective oxidation of vicinal diols; CARBOHYDRATE RESEARCH, 339 (11): 1889-1897 AUG 2 2004.
3. Barros MT, Maycock CD, Rodrigues P, Thomassigny C; Improved anomeric selectivity for the aroylation of sugars; CARBOHYDRATE RESEARCH, 339 (7): 1373-1376 MAY 17 2004.
4. Vergeer FW, Matousek P, Towrie M, Costa PL, Calhorda ML, Hartl F; Low-lying excited states and primary photoproducts of [Os-3(CO)(10)-(s-cis-L)] (L = cyclohexa-1,3-diene, buta-1,3-diene) clusters studied by picosecond time-resolved UV/Vis and IR spectroscopy and by density functional theory; CHEMISTRY-A EUROPEAN JOURNAL, 10 (14): 3451-3460 JUL 19 2004.
5. Veiros LF, Dazinger G, Kirchner K, Calhorda MJ, Schmid R; By what mechanisms are metal cyclobutadiene complexes formed from alkynes?; CHEMISTRY-A EUROPEAN JOURNAL, 10 (22): 5860-5870 NOV 19 2004.
6. Santos AM, Pedro FM, Yogalekar AA, Lucas IS, Romão CC, Kuhn FE; Oxorhenium complexes as aldehyde-olefination catalysts; CHEMISTRY-A EUROPEAN JOURNAL, 10 (24): 6313-6321 DEC 17 2004.
7. Cui XL, Carapuça HM, Delgado R, Drew MGB, Felix V; Bis[1,1'-N,N'-(2-picolyl)aminomethyl]ferrocene as a redox sensor for transition metal ions; DALTON TRANSACTIONS, (11): 1743-1751 2004.
8. Guerra KP, Delgado R, Lima LSMP, Drew MGB, Félix VT; Bis- and tris-(methylphosphonic) acid derivatives of a 14-membered tetraazamacrocyclic containing pyridine: synthesis, protonation and complexation studies; DALTON TRANSACTIONS, (12): 1812-1822 2004.

9. Pessoa JC, Calhorda MJ, Cavaco I, Costa PJ, Correia I, Costa D, Vilas-Boas LF, Felix V, Gillard RD, Henriques RT, Wiggins R; N-salicylideneamino acidato complexes of oxovanadium(IV). The cysteine and penicillamine complexes; DALTON TRANSACTIONS, (18): 2855-2866 2004.
10. Aguado JE, Calhorda MJ, Costa PJ, Crespo O, Felix V, Gimeno MC, Jones PG, Laguna A; Synthesis and theoretical studies of a double helical complex with the ligand 4',4''-Bis(ferrocenyl)-2,2':6',2''':6''',2''''-CuinCuepyridine; EUROPEAN JOURNAL OF INORGANIC CHEMISTRY, (15): 3038-3047 AUG 6 2004.
11. Royo B, Herdtweck E, Romão CC; Synthesis and structural characterization of novel oxorhenium(V) complexes containing N-heterocyclic carbenes; EUROPEAN JOURNAL OF INORGANIC CHEMISTRY, (16): 3305-3309 AUG 20 2004.
12. Abrantes M, Gago S, Valente AA, Pillinger M, Goncalves IS, Santos TM, Rocha J, Romão CC; Incorporation of a (cyclopentadienyl)molybdenum oxo complex in MCM-41 and its use as a catalyst for olefin epoxidation; EUROPEAN JOURNAL OF INORGANIC CHEMISTRY, (24): 4914-4920 DEC 17 2004.
13. Fernandes AC, Romão CC, Rosa CP, Vieira VP, Lopes A, Silva PF, Maçanita AL; One-step synthesis of novel flavylum salts containing alkyl side chains in their 3-, 4'-, 5- or 6-positions and their photophysical properties in micellar media; EUROPEAN JOURNAL OF ORGANIC CHEMISTRY, (23): 4877-4883 NOV 26 2004.
14. Barros MT, Maycock CD, Phillips AMF; Novel cyclic 1,2-diacetals derived from (2R,3R)-(+)-tartaric acid: Synthesis and application as N,O ligands for the enantioselective alkylation of benzaldehyde by diethylzinc; EUROPEAN JOURNAL OF ORGANIC CHEMISTRY, (8): 1820-1829 APR 2004.
15. Cui XL, Calhorda MJ, Costa PJ, Delgado R, Drew MGB, Felix V; Structure, characterization, and metal-complexation properties of a new tetraazamacrocyclic containing two phenolic pendant arms; HELVETICA CHIMICA ACTA, 87 (10): 2613-2628 2004.
16. Marques F, Guerra KP, Gano L, Costa J, Campello MP, Lima LMP, Delgado R, Santos I; Sm-153 and Ho-166 complexes with tetraaza macrocycles containing pyridine and methylcarboxylate or methylphosphonate pendant arms; JOURNAL OF BIOLOGICAL INORGANIC CHEMISTRY, 9 (7): 859-872 OCT 2004.
17. Martins J, Melo E, Naqvi KR; Reappraisal of four different approaches for finding the mean reaction time in the multi-trap variant of the Adam-Delbruck problem; JOURNAL OF CHEMICAL PHYSICS, 120 (19): 9390-9393 MAY 15 2004.
18. Almeida CMM, Boas LV; Analysis of BTEX and other substituted benzenes in water using headspace SPME-GC-FID: method validation; JOURNAL OF ENVIRONMENTAL MONITORING, 6 (1): 80-88 2004.
19. Valente AA, Petrovski Z, Branco LC, Afonso CAM, Pillinger M, Lopes AD, Romão CC, Nunes CD, Gonçalves IS; Epoxidation of cyclooctene catalyzed by dioxomolybdenum(VI) complexes in ionic liquids; JOURNAL OF MOLECULAR CATALYSIS A-CHEMICAL, 218 (1): 5-11 AUG 17 2004.
20. Barros MT, Burke AJ, Lou JD, Maycock CD, Wahnou JR; Highly stereoselective aldol reaction for the synthesis of gamma-lactones starting from tartaric acid; JOURNAL OF ORGANIC CHEMISTRY, 69 (23): 7847-7850 NOV 12 2004.
21. Liu HZ, Bandeira NAG, Calhorda MJ, Drew MGB, Felix V, Novosad J, de Biani FF, Zanello P; Cu(I) and Ag(I) complexes of chalcogenide derivatives of the organometallic ligand dppf and the dppa analogue; JOURNAL OF ORGANOMETALLIC CHEMISTRY, 689 (17): 2808-2819 SEP 1 2004.
22. Noronha M, Lima JC, Lamosa P, Santos H, Maycock C, Ventura R, Maçanita AL; Intramolecular fluorescence Quenching of tyrosine by the peptide alpha-carbonyl group revisited; JOURNAL OF PHYSICAL CHEMISTRY A, 108 (12): 2155-2166 MAR 25 2004. (also in Biology Division)
23. Bai GY, Santos LMNBF, Nichifor M, Lopes A, Bastos M; Thermodynamics of the interaction between a hydrophobically modified polyelectrolyte and sodium dodecyl sulfate in aqueous solution; JOURNAL OF PHYSICAL CHEMISTRY B, 108 (1): 405-413 JAN 8 2004.

24. Nichifor M, Lopes S, Bastos M, Lopes A; Self-aggregation of amphiphilic cationic polyelectrolytes based on polysaccharides; JOURNAL OF PHYSICAL CHEMISTRY B, 108 (42): 16463-16472 OCT 21 2004.
25. Murgida DH, Hildebrandt P, Wei J, He YF, Liu HY, Waldeck DH; Surface-enhanced resonance Raman spectroscopic and electrochemical study of cytochrome c bound on electrodes through coordination with pyridinyl-terminated self-assembled monolayers; JOURNAL OF PHYSICAL CHEMISTRY B, 108 (7): 2261-2269 FEB 19 2004.
26. Lenco A, Calhorda MJ, Reinhold J, Reineri F, Bianchini C, Peruzzini M, Vizza F, Mealli C; Activation of molecular hydrogen over a binuclear complex with Rh₂S₂ core: DFT calculations and NMR mechanistic studies; JOURNAL OF THE AMERICAN CHEMICAL SOCIETY, 126 (38): 11954-11965 SEP 29 2004.
27. Ramos A, Neves AR, Ventura R, Maycock C, Lopez P, Santos H; Effect of pyruvate kinase overproduction on glucose metabolism of *Lactococcus lactis*; MICROBIOLOGY-SGM, 150: 1103-1111 PART 4 APR 2004. (also in the Biology Division)
28. Kuhn FE, Zuo JL, de Biani FF, Santos AM, Zhang YM, Zhao J, Sandulache A, Herdtweck E; 4-ethynylpyridine as bridging moiety in mixed Ru/Re complexes; NEW JOURNAL OF CHEMISTRY, 28 (1): 43-51 2004.
29. Valente AA, Moreira J, Lopes AD, Pillinger M, Nunes CD, Romão CC, Kuhn FE, Gonçalves IS; Dichloro and dimethyl dioxomolybdenum(VI)-diazabutadiene complexes as catalysts for the epoxidation of olefins; NEW JOURNAL OF CHEMISTRY, 28 (2): 308-313 FEB 2004.
30. Cruz C, Delgado R, Drew MGB, Felix V; Supramolecular aggregates between carboxylate anions and an octaaza macrocyclic receptor; ORGANIC & BIOMOLECULAR CHEMISTRY, 2 (20): 2911-2918 2004.
31. Cadierno V, Diez J, Garcia-Alvarez J, Gimeno J, Calhorda MJ, Veiros LF; Bis(iminophosphorano)methane derivatives as precursors of unusual ruthenium carbene complexes: A synthetic and DFT study; ORGANOMETALLICS, 23 (10): 2421-2433 MAY 10 2004; (Review)
32. Godinho SSMC, Royo B, Lobato MT, Herdtweck E, Romão CC; Synthesis and structure of diphenylphosphine derivatives of molybdenocene; POLYHEDRON, 23 (7): 1263-1270 APR 15 2004.

2005

1. Fernandes AC, Fernandes R, Romão CC, Royo B; [MoO₂Cl₂] as catalyst for hydrosilylation of aldehydes and ketones; CHEMICAL COMMUNICATIONS, (2): 213-214 2005.
2. Li F, Delgado R, Costa J, Drew MGB, Felix V; Ditopic hexaazamacrocycles containing pyridine: synthesis, protonation and complexation studies; DALTON TRANSACTIONS, (1): 82-91 2005.
3. Petrovski Z, Pillinger M, Valente AA, Gonçalves IS, Hazell A, Romão CC; Preparation and catalytic studies of bis(halogeno) dioxomolybdenum(VI)-diimine complexes; JOURNAL OF MOLECULAR CATALYSIS A-CHEMICAL, 227 (1-2): 67-73 MAR 1 2005.
4. Bai GY, Nichifor M, Lopes A, Bastos M; Thermodynamic characterization of the interaction behavior of a hydrophobically modified polyelectrolyte and oppositely charged surfactants in aqueous solution: Effect of surfactant alkyl chain length; JOURNAL OF PHYSICAL CHEMISTRY B, 109 (1): 518-525 JAN 13 2005.
5. Kuhn FE, Zhao J, Abrantes M, Sun W, Afonso CAM, Branco LC, Gonçalves IS, Pillinger M, Romão CC; Catalytic olefin epoxidation with cyclopentadienyl-molybdenum complexes in room temperature ionic liquids; TETRAHEDRON LETTERS, 46 (1): 47-52 JAN 3 2005.
6. Lacerda S, Campello MP, Santos IC, Santos I, Delgado R; A N,N'-diacetate benzodioxotetraazamacrocyclic and its transition metal complexes; POLYHEDRON, 24, 651-661 2005.
7. Delgado R, Costa J, Guerra KP, Lima LMP; Lanthanide complexes of macrocyclic derivatives useful for medical applications: a critical evaluation of stability constants; PURE AND APPLIED CHEMISTRY, 77, 569-579 2005.

In Press

1. Petrovski Z, Braga SS, Rodrigues SS, Pereira CCL, Gonçalves IS, Pillinger M, Freire AC, Romão CC; Synthesis of ferrocenyldiimine metal carbonyl complexes and an investigation of the Mo adduct encapsulated in cyclodextrin; NEW JOURNAL OF CHEMISTRY.
2. Valente AA, Seixas JD, Gonçalves IS, Abrantes M, Pillinger M, Romão CC, CATALYSIS LETTERS.

BIOLOGY DIVISION

ISI Papers

2004

1. Gaspar P, Neves AR, Ramos A, Gasson MJ, Shearman CA, Santos H; Engineering *Lactococcus lactis* for production of mannitol: High yields from food-grade strains deficient in lactate dehydrogenase and the mannitol transport system; APPLIED AND ENVIRONMENTAL MICROBIOLOGY, 70 (3): 1466-1474 MAR 2004.
2. Duc LH, Hong HA, Barbosa TM, Henriques AO, Cutting SM; Characterization of *Bacillus probiotics* available for human use; APPLIED AND ENVIRONMENTAL MICROBIOLOGY, 70 (4): 2161-2171 APR 2004.
3. Vieira HLA, Freire P, Arraiano CM; Effect of *Escherichia coli* morphogene *bolA* on biofilms; APPLIED AND ENVIRONMENTAL MICROBIOLOGY, 70 (9): 5682-5684 SEP 2004.
4. Amblar M, Viegas SC, Lopez P, Arraiano CM; Homologous and heterologous expression of RNase III from *Lactococcus lactis*; BIOCHEMICAL AND BIOPHYSICAL RESEARCH COMMUNICATIONS, 323 (3): 884-890 OCT 22 2004.
5. Crystal AS, Morais VA, Fortna RR, Carlin D, Pierson TC, Wilson CA, Lee VMY, Doms RW; Presenilin modulates Pen-2 levels posttranslationally by protecting it from proteasomal degradation; BIOCHEMISTRY, 43 (12): 3555-3563 MAR 30 2004.
6. Sousa VL, Brito C, Costa J; Deletion of the cytoplasmic domain of human 3/4 fucosyltransferase III causes the shift of the enzyme to early Golgi compartments; BIOCHIMICA ET BIOPHYSICA ACTA-GENERAL SUBJECTS, 1675 (1-3): 95-104 NOV 18 2004.
7. Palma AS, Morais VA, Coelho AV, Costa J; Effect of the manganese ion on human 3/4 fucosyltransferase III activity; BIOMETALS, 17 (1): 35-43 FEB 2004.
8. Noronha M, Lima JC, Bastos M, Santos H, Maçanita AL; Unfolding of ubiquitin studied by picosecond time-resolved fluorescence of the tyrosine residue; BIOPHYSICAL JOURNAL, 87 (4): 2609-2620 OCT 2004.
9. Marcos NT, Pinho S, Grandela C, Cruz A, Samyn-Petit B, Harduin-Lepers A, Almeida R, Silva F, Morais V, Costa J, Kihlberg J, Clausen H, Reis CA; Role of the human ST6GalNAc-I and ST6GalNAc-II in the synthesis of the cancer-associated sialyl-Tn antigen; CANCER RESEARCH, 64 (19): 7050-7057 OCT 1 2004.
10. de Sousa MA, de Lencastre H; Bridges from hospitals to the laboratory: genetic portraits of methicillin-resistant *Staphylococcus aureus* clones; FEMS IMMUNOLOGY AND MEDICAL MICROBIOLOGY, 40 (2): 101-111 MAR 8 2004; (Review)
11. Leal TF, de Sa-Nogueira I; Purification, characterization and functional analysis of an endo-arabinanase (AbnA) from *Bacillus subtilis*; FEMS MICROBIOLOGY LETTERS, 241 (1): 41-48 DEC 1 2004.
12. Cardoso FS, Gaspar P, Hugenholtz J, Ramos A, Santos H; Enhancement of trehalose production in dairy propionibacteria through manipulation of environmental conditions; INTERNATIONAL JOURNAL OF FOOD MICROBIOLOGY, 91 (2): 195-204 MAR 1 2004.
13. Serrano M, Neves A, Soares CM, Moran CP, Henriques AO; Role of the anti-sigma factor SpoIIAB in regulation of σ^G during *Bacillus subtilis* sporulation; JOURNAL OF BACTERIOLOGY, 186 (12): 4000-4013 JUN 2004.

14. Empadinhas N, Albuquerque L, Costa J, Zinder SH, Santos MAS, Santos H, da Costa MS; A gene from the mesophilic bacterium *Dehalococcoides ethenogenes* encodes a novel mannosylglycerate synthase; JOURNAL OF BACTERIOLOGY, 186 (13): 4075-4084 JUL 2004.
15. Zilhao R, Serrano M, Isticato R, Ricca E, Moran CP, Henriques AO; Interactions among CotB, CotG, and CotH during assembly of the *Bacillus subtilis* spore coat; JOURNAL OF BACTERIOLOGY, 186 (4): 1110-1119 FEB 2004.
16. Isticato R, Esposito G, Zilhao R, Nolasco S, Cangiano G, De Felice M, Henriques AO, Ricca E; Assembly of multiple CotC forms into the *Bacillus subtilis* spore coat; JOURNAL OF BACTERIOLOGY, 186 (4): 1129-1135 FEB 2004.
17. Raposo MP, Inacio JM, Mota LJ, de Sa-Nogueira I; Transcriptional regulation of genes encoding arabinan-degrading enzymes in *Bacillus subtilis*; JOURNAL OF BACTERIOLOGY, 186 (5): 1287-1296 MAR 2004.
18. Costa T, Steil L, Martins LO, Volker U, Henriques AO; Assembly of an oxalate decarboxylase produced under λ control into the *Bacillus subtilis* spore coat; JOURNAL OF BACTERIOLOGY, 186 (5): 1462-1474 MAR 2004.
19. Gardete S, Ludovice AM, Sobral RG, Filipe SR, de Lencastre H, Tomasz A; Role of *murE* in the expression of beta-lactam antibiotic resistance in *Staphylococcus aureus*; JOURNAL OF BACTERIOLOGY, 186 (6): 1705-1713 MAR 2004.
20. Borges N, Marugg JD, Empadinhas N, da Costa MS, Santos H; Specialized roles of the two pathways for the synthesis of mannosylglycerate in osmoadaptation and thermoadaptation of *Rhodothermus marinus*; JOURNAL OF BIOLOGICAL CHEMISTRY, 279 (11): 9892-9898 MAR 12 2004.
21. Faria TQ, Lima JC, Bastos M, Maçanita AL, Santos H; Protein stabilization by osmolytes from hyperthermophiles - Effect of mannosylglycerate on the thermal unfolding of recombinant nuclease a from *Staphylococcus aureus* studied by picosecond time-resolved fluorescence and calorimetry; JOURNAL OF BIOLOGICAL CHEMISTRY, 279 (47): 48680-48691 NOV 19 2004.
22. Fortna RR, Crystal AS, Morais VA, Pijak DS, Lee VMY, Doms RW; Membrane topology and nicastrin-enhanced endoproteolysis of APH-1, a component of the gamma-secretase complex; JOURNAL OF BIOLOGICAL CHEMISTRY, 279 (5): 3685-3693 JAN 30 2004.
23. Sampaio MM, Chevance F, Dippel R, Eppler T, Schlegel A, Boos W, Lu YJ, Rock CO; Phosphotransferase-mediated transport of the osmolyte 2-O-alpha-mannosylglycerate in *Escherichia coli* occurs by the product of the *mngA (hrsA)* gene and is regulated by the *mngR (farR)* gene product acting as repressor; JOURNAL OF BIOLOGICAL CHEMISTRY, 279 (7): 5537-5548 FEB 13 2004.
24. Chung M, Dickinson G, de Lencastre H, Tomasz A; International clones of methicillin-resistant *Staphylococcus aureus* in two hospitals in Miami, Florida; JOURNAL OF CLINICAL MICROBIOLOGY, 42 (2): 542-547 FEB 2004.
25. Velazquez-Meza ME, de Sousa MA, Echaniz-Aviles G, Solorzano-Santos F, Miranda-Novales G, Silva-Sanchez J, de Lencastre H; Surveillance of methicillin-resistant *Staphylococcus aureus* in a pediatric hospital in Mexico city during a 7-year period (1997 to 2003): Clonal evolution and impact of infection control; JOURNAL OF CLINICAL MICROBIOLOGY, 42 (8): 3877-3880 AUG 2004.
26. Silva J, Carvalho AS, Pereira H, Teixeira P, Gibbs PA; Induction of stress tolerance in *Lactobacillus delbrueckii* ssp *bulgaricus* by the addition of sucrose to the growth medium; JOURNAL OF DAIRY RESEARCH, 71 (1): 121-125 FEB 2004.
27. Melter O, De Sousa MA, Laskafeldova K, Urbaskova P, Wunschova M, de Lencastre H; Delineation of the endemic and sporadic methicillin-resistant *Staphylococcus aureus* clones in a Czech hospital; MICROBIAL DRUG RESISTANCE-MECHANISMS EPIDEMIOLOGY AND DISEASE, 10 (3): 218-223 FAL 2004.
28. Mato R, Campanile F, Stefani S, Crisostomo MI, Santagati M, Sanches IS, de Lencastre H; Clonal types and multidrug resistance patterns of methicillin-resistant *Staphylococcus aureus* (MRSA) recovered in Italy during the 1990s; MICROBIAL DRUG RESISTANCE-MECHANISMS EPIDEMIOLOGY AND DISEASE, 10 (2): 106-113 SUM 2004.

29. Figueira-Coelho J, Ramirez M, Salgado MJ, Melo-Cristino J; *Streptococcus agalactiae* in a large Portuguese teaching hospital: Antimicrobial susceptibility, serotype distribution, and clonal analysis of macrolide-resistant isolates; MICROBIAL DRUG RESISTANCE-MECHANISMS EPIDEMIOLOGY AND DISEASE, 10 (1): 31-36 SPR 2004.
30. Ramos A, Neves AR, Ventura R, Maycock C, Lopez P, Santos H; Effect of pyruvate kinase overproduction on glucose metabolism of *Lactococcus lactis*; MICROBIOLOGY-SGM, 150: 1103-1111 PART 4 APR 2004. (also in the Chemistry Division)
31. Isidro A, Santos MA, Henriques AO, Tavares P; The high-resolution functional map of bacteriophage SPP1 portal protein; MOLECULAR MICROBIOLOGY, 51 (4): 949-962 FEB 2004.
32. Viegas SC, de Palencia PF, Amblar M, Arraiano CM, Lopez P; Development of an inducible system to control and easily monitor gene expression in *Lactococcus lactis*; PLASMID, 51 (3): 256-264 MAY 2004.
33. Isidro A, Henriques AO, Tavares P; The portal protein plays essential roles at different steps of the SPP1 DNA packaging process; VIROLOGY, 322 (2): 253-263 MAY 1 2004.
34. Noronha M, Lima JC, Lamosa P, Santos H, Maycock C, Ventura R, Maçanita AL; Intramolecular fluorescence Quenching of tyrosine by the peptide alpha-carbonyl group revisited; JOURNAL OF PHYSICAL CHEMISTRY A, 108 (12): 2155-2166 MAR 25 2004. (also in Chemistry Division)

2005

1. Gomes AR, Vinga S, Zavolan M, de Lencastre H; Analysis of the genetic variability of virulence-related loci in epidemic clones of methicillin-resistant *Staphylococcus aureus*; ANTIMICROBIAL AGENTS AND CHEMOTHERAPY, 49 (1): 366-379 JAN 2005
2. Real G, Autret S, Harry EJ, Errington J, Henriques AO; Cell division protein DivIB influences the Spo0J/Soj system of chromosome segregation in *Bacillus subtilis*; MOLECULAR MICROBIOLOGY, 55 (2): 349-367 JAN 2005
3. Pais TM, Lamosa P, dos Santos W, LeGall J, Turner DL, Santos H; Structural determinants of protein stabilization by solutes: the importance of the hairpin loop in rubredoxins; EUROPEAN JOURNAL OF BIOCHEMISTRY, 272, 999-1011 FEB 2005
4. Silva Z, Sampaio M-M, Henne A, Böhm A, Gutzat R, Boos W, da Costa MS, Santos H; The high-affinity maltose/trehalose abc transporter in the extremely thermophilic bacterium *Thermus thermophilus* HB27 also recognizes sucrose and palatinose; JOURNAL OF BACTERIOLOGY, 187, 1210-1218 FEB 2005

In Press

1. Palma A, de Carvalho M, Barata N, Evangelista T, Chicau P, Regalla M, Costa J; Biochemical characterization of plasma in amyotrophic lateral sclerosis: amino acid and protein composition; AMYOTROPHIC LATERAL SCLEROSIS AND OTHER MOTOR NEURON DISORDERS.
2. Alarico S, Silva Z, Simões C, Henne A, Mingote A, Santos H, da Costa MS; Distribution of genes for the synthesis of trehalose and mannosylglycerate in *Thermus* spp. and direct correlation with halotolerance; APPLIED AND ENVIRONMENTAL MICROBIOLOGY.
3. Cairrão F, Rendall S, Arraiano CM, Newbury SF; The Drosophila gene *tazman*, an orthologue of the yeast exosome component Rrp44p/dis3, is differentially expressed during development; Developmental Dynamics.
4. Amblar M, Arraiano CM; A single mutation in *Escherichia coli* Ribonuclease II inactivates the enzyme without affecting RNA binding; European Journal of Biochemistry.
5. Fonseca LL, Monteiro MAR, Alves PM, Carrondo MJT, Santos H; Cultures of rat astrocytes challenged with a steady supply of glutamate: a new model to study flux distribution in the glutamate-glutamine cycle; GLIA.
6. Nunes S, Sá-Leão R, Carriço J, Alves C R, Mato R, Brito-Avô A, Saldanha J, Almeida JS, Santos Sanches I, de Lencastre H; Trends in drug resistance, serotypes and molecular types of *Streptococcus pneumoniae* colonizing pre-school age children attending day care centers in Lisbon, Portugal – a summary of four years of annual surveillance; JOURNAL OF CLINICAL BIOLOGY.

7. Frazão N, Brito-Avô A, Simas C, Saldanha J, Mato R, Nunes S, Sousa NG, Carriço J, Almeida J, Santos-Sanches I, de Lencastre H; Effect of the 7-valent conjugate pneumococcal vaccine on carriage and drug resistance of *Streptococcus pneumoniae* in healthy children attending day-care centers in Lisbon; PEDIATRIC AND INFECTIOUS DISEASES.

PATENTS

1. Santos H, Lamosa P, Jorge C, da Costa MS; Diglycosyl glyceryl compounds for the stabilisation and preservation of biomaterials; International Patent published on 04/11/04 (International Publication Number WO 2004/094631 A1). Filed *via* IBET.

BIOLOGICAL CHEMISTRY DIVISION

ISI Papers

2004

1. de Backer MME, McSweeney S, Lindley PF, Hough E; Ligand-binding and metal-exchange crystallographic studies on shrimp alkaline phosphatase; ACTA CRYSTALLOGRAPHICA SECTION D-BIOLOGICAL CRYSTALLOGRAPHY, 60: 1555-1561 PART 9 SEP 2004.
2. Saraiva LM, Vicente JB, Teixeira M; The role of the flavodiiron proteins in microbial nitric oxide detoxification; ADVANCES IN MICROBIAL PHYSIOLOGY, VOL. 49, 49: 77-129 2004; (Review)
3. Crowley PB, Hunter DM, Sato K, McFarlane W, Dennison C; The parsley plastocyanin-turnip cytochrome f complex: a structurally distorted but kinetically functional acidic patch; BIOCHEMICAL JOURNAL, 378: 45-51 PART 1 FEB 15 2004.
4. Nevitt T, Pereira J, Azevedo D, Guerreiro P, Rodrigues-Pousada C; Expression of YAP4 in *Saccharomyces cerevisiae* under osmotic stress; BIOCHEMICAL JOURNAL, 379: 367-374 PART 2 APR 15 2004.
5. Urich T, Bandejas TM, Leal SS, Rachel R, Albrecht T, Zimmermann P, Scholz C, Teixeira M, Gomes CM, Kletzin A; The sulphur oxygenase reductase from *Acidianus ambivalens* is a multimeric protein containing a low-potential mononuclear non-haem iron centre; BIOCHEMICAL JOURNAL, 381: 137-146 PART 1 JUL 1 2004.
6. Pessanha M, Londer YY, Long WC, Erickson J, Pokkuluri PR, Schiffer M, Salgueiro CA; Redox characterization of *Geobacter sulfurreducens* cytochrome c_7 : Physiological relevance of the conserved residue F15 probed by site-specific mutagenesis; BIOCHEMISTRY, 43 (30): 9909-9917 AUG 3 2004.
7. Feio MJ, Navarro JA, Teixeira MS, Harrison D, Karlsson BG, De la Rosa MA; A thermal unfolding study of plastocyanin from the thermophilic cyanobacterium *Phormidium laminosum*; BIOCHEMISTRY, 43 (46): 14784-14791 NOV 23 2004.
8. Das TK, Gomes CM, Bandejas TM, Pereira MM, Teixeira M, Rousseau DL; Active site structure of the aa_3 quinol oxidase of *Acidianus ambivalens*; BIOCHIMICA ET BIOPHYSICA ACTA-BIOENERGETICS, 1655 (1-3): 306-320 APR 12 2004; (Review)
9. Pereira MM, Teixeira M; Proton pathways, ligand binding and dynamics of the catalytic site in haem-copper oxygen reductases: a comparison between the three families; BIOCHIMICA ET BIOPHYSICA ACTA-BIOENERGETICS, 1655 (1-3): 340-346 APR 12 2004; (Review)
10. Xavier AV; Thermodynamic and choreographic constraints for energy transduction by cytochrome c oxidase; BIOCHIMICA ET BIOPHYSICA ACTA-BIOENERGETICS, 1658 (1-2): 23-30 Sp. Iss. SI JUL 23 2004.
11. Teixeira VH, Baptista AM, Soares CM; Modeling electron transfer thermodynamics in protein complexes: Interaction between two cytochromes c_3 ; BIOPHYSICAL JOURNAL, 86 (5): 2773-2785 MAY 2004.
12. Victor BL, Baptista AM, Soares CM; Theoretical identification of proton channels in the quinol oxidase aa_3 from *Acidianus ambivalens*; BIOPHYSICAL JOURNAL, 87 (6): 4316-4325 DEC 2004.

13. Vidinha P, Harper N, Micaêlo NM, Lourenço NMT, da Silva MDRG, Cabral JMS, Afonso CAM, Soares CM, Barreiros S; Effect of immobilization support, water activity, and enzyme ionization state on cutinase activity and enantioselectivity in organic media; BIOTECHNOLOGY AND BIOENGINEERING, 85 (4): 442-449 FEB 20 2004.
14. Sarti P, Fiori PL, Forte E, Rappelli P, Teixeira M, Mastronicola D, Sanciú G, Giuffrè A, Brunori M; *Trichomonas vaginalis* degrades nitric oxide and expresses a flavorubredoxin-like protein: a new pathogenic mechanism?; CELLULAR AND MOLECULAR LIFE SCIENCES, 61 (5): 618-623 MAR 2004.
15. Menezes RA, Amaral C, Delaunay AS, Toledano M, Rodrigues-Pousada C; Yap8p activation in *Saccharomyces cerevisiae* under arsenic conditions; FEBS LETTERS, 566 (1-3): 141-146 MAY 21 2004.
16. Rodrigues-Pousada CA, Nevitt T, Menezes R, Azevedo D, Pereira J, Amaral C; Yeast activator proteins and stress response: an overview; FEBS LETTERS, 567 (1): 80-85 JUN 1 2004.
17. Louro RO, Catarino T, Paquete CM, Turner DL; Distance dependence of interactions between charged centres in proteins with common structural features; FEBS LETTERS, 576 (1-2): 77-80 OCT 8 2004.
18. Pessanha M, Rothery EL, Louro RO, Turner DL, Miles CS, Reid GA, Chapman SK, Xavier AV, Salgueiro CA; Redox behaviour of the haem domain of flavocytochrome c_3 from *Shewanella frigidimarina* probed by NMR; FEBS LETTERS, 578 (1-2): 185-190 DEC 3 2004.
19. Serrano M, Neves A, Soares CM, Moran CP, Henriques AO; Role of the anti-sigma factor SpoIIAB in regulation of σ^G during *Bacillus subtilis* sporulation; JOURNAL OF BACTERIOLOGY, 186 (12): 4000-4013 JUN 2004.
20. Kletzin A, Urich T, Müller F, Bandejas TM, Gomes CM; Dissimilatory oxidation and reduction of elemental sulfur in thermophilic archaea; JOURNAL OF BIOENERGETICS AND BIOMEMBRANES, 36 (1): 77-91 FEB 2004; (Review)
21. Pereira MM, Bandejas TM, Fernandes AS, Lemos RS, Melo AMP, Teixeira M; Respiratory chains from aerobic thermophilic prokaryotes; JOURNAL OF BIOENERGETICS AND BIOMEMBRANES, 36 (1): 93-105 FEB 2004; (Review)
22. Enguita FJ, Marcal D, Martins LO, Grenha R, Henriques AO, Lindley PF, Carrondo MA; Substrate and dioxygen binding to the endospore coat laccase from *Bacillus subtilis*; JOURNAL OF BIOLOGICAL CHEMISTRY, 279 (22): 23472-23476 MAY 28 2004.
23. Correia IJ, Paquete CM, Coelho A, Almeida CC, Catarino T, Louro RO, Frazão C, Saraiva LM, Carrondo MA, Turner DL, Xavier AV; Proton-assisted two-electron transfer in natural variants of tetraheme cytochromes from *Desulfomicrobium* sp.; JOURNAL OF BIOLOGICAL CHEMISTRY, 279 (50): 52227-52237 DEC 10 2004.
24. Soares CM, Baptista AM, Pereira MM, Teixeira M; Investigation of protonatable residues in *Rhodothermus marinus* caa_3 haem-copper oxygen reductase: comparison with *Paracoccus denitrificans* caa_3 haem-copper oxygen reductase; JOURNAL OF BIOLOGICAL INORGANIC CHEMISTRY, 9 (2): 124-134 MAR 2004.
25. Leal SS, Teixeira M, Gomes CM; Studies on the degradation pathway of iron-sulfur centers during unfolding of a hyperstable ferredoxin: cluster dissociation, iron release and protein stability; JOURNAL OF BIOLOGICAL INORGANIC CHEMISTRY, 9 (8): 987-996 DEC 2004.
26. Müller FH, Bandejas TM, Urich T, Teixeira M, Gomes CM, Kletzin A; Coupling of the pathway of sulphur oxidation to dioxygen reduction: characterization of a novel membrane-bound thiosulphate : quinone oxidoreductase; MOLECULAR MICROBIOLOGY, 53 (4): 1147-1160 AUG 2004.
27. Saibo NJM, Van Der Straeten D, Rodrigues-Pousada C; *Lupinus albus* gamma-tubulin: mRNA and protein accumulation during development and in response to darkness; PLANTA, 219 (2): 201-211 JUN 2004.
28. Pokkuluri PR, Londer YY, Duke NEC, Erickson J, Pessanha M, Salgueiro CA, Schiffer M; Structure of a novel c_7 -type three-heme cytochrome domain from a multidomain cytochrome c polymer; PROTEIN SCIENCE, 13 (6): 1684-1692 JUN 2004.

29. Eberini I, Baptista AM, Gianazza E, Fraternali F, Beringhelli T; Reorganization in apo- and holo-beta-lactoglobulin upon protonation of Glu89: Molecular dynamics and pK_a calculations; PROTEINS-STRUCTURE FUNCTION AND BIOINFORMATICS, 54 (4): 744-758 MAR 1 2004.
30. Crowley PB, Carrondo MA; The architecture of the binding site in redox protein complexes: Implications for fast dissociation; PROTEINS-STRUCTURE FUNCTION AND BIOINFORMATICS, 55 (3): 603-612 MAY 15 2004.
31. Bento I, Matias PM, Baptista AM, da Costa PN, van Dongen WMAM, Saraiva LM, Schneider TR, Soares CM, Carrondo MA; Molecular basis for redox-Bohr and cooperative effects in cytochrome c₃ from *Desulfovibrio desulfuricans* ATCC 27774: Crystallographic and modeling studies of oxidized and reduced high-resolution structures at pH 7.6; PROTEINS-STRUCTURE FUNCTION AND GENETICS, 54 (1): 135-152 JAN 1 2004.
32. Nevitt T, Pereira J, Rodrigues-Pousada C; YAP4 gene expression is induced in response to several forms of stress in *Saccharomyces cerevisiae*; YEAST, 21 (16): 1365-1374 DEC 2004.

2005

1. Rodrigues ML, Bonifácio MJ, Soares-da-Silva P, Carrondo MA, Archer M; Crystallization and preliminary X-ray diffraction studies of catechol-O-methyltransferase/inhibitor complex; ACTA CRYSTALLOGRAPHICA F61, 118-120 2005
2. Justino MC, Vicente JB, Teixeira M, Saraiva LM; New genes implicated in the protection of anaerobically grown *Escherichia coli* against nitric oxide; JOURNAL OF BIOLOGICAL CHEMISTRY, 280 (4): 2636-2643 JAN 28 2005
3. Srinivasan V, Rajendran C, Sousa FL, Melo AMP, Saraiva LM, Pereira MM, Santana M, Teixeira M, Micel H; Structure at 1.3 angstrom resolution of *Rhodothermus marinus* caa₃ cytochrome c domain; JOURNAL OF MOLECULAR BIOLOGY, 345 (5): 1047-1057 FEB 4 2005

In Press

1. Ulrich T, Coelho R, Af Kletzin, Frazão C; The sulfur oxygenase reductase from *Acidianus ambivalens* is an icosatetramer as shown by crystallization and Patterson analysis; BBA PROTEINS AND PROTEOMICS.
2. Justino MC, Gonçalves VMM and Saraiva LM; Binding of NorR to three DNA sites is essential for promoter activation of the flavorubredoxin gene, the nitric oxide reductase of *Escherichia coli*; BIOCHEMICAL AND BIOPHYSICAL RESEARCH COMMUNICATIONS.
3. Frazão C, Simes DC, Coelho R, Alves D, Williamson MK, Price PA, Cancela ML, Carrondo MA; Structural evidence of a fourth Gla residue in fish osteocalcin: Biological implications; BIOCHEMISTRY.
4. Díaz-Moreno IM, Díaz-Quintana A, de la Rosa MA, Crowley PB, Ubbink M; Different modes of interaction in cyanobacterial complexes of plastocyanin and cytochrome f; BIOCHEMISTRY.
5. Fonseca LL, Monteiro MAR, Alves PM, Carrondo MJT, Santos H; Cultures of rat astrocytes challenged with a steady supply of glutamate: a new model to study flux distribution in the glutamate-glutamine cycle; GLIA.
6. Matias PM, Pereira IAC, Soares CM, Carrondo MA; Sulphate respiration from hydrogen in *Desulfovibrio* bacteria: a structural biology overview; PROGRESS IN BIOPHYSICS AND MOLECULAR BIOLOGY.
7. Crowley PB, Golovin A; Cation-pi interactions in protein-protein interfaces Proteins; STRUCTURE, FUNCTION AND BIOINFORMATICS.

BOOK CHAPTERS

1. Pereira IAC, Xavier AV; MultiHeme c Cytochromes and Enzymes; Encyclopedia of Inorganic Chemistry, 2nd Ed., Wiley In Press.

TECHNOLOGY DIVISION

ISI Papers

2004

1. Miranda J, Stumme B, Beyer D, Cruz H, Oliva,AG, Wicklein, D, Yin H, Jianxun L, Ahmed, JS, Seitzer U; Identification of antigenic proteins of a *Theileria* species pathogenic for small ruminants in China: characterization of the immune response and assessment of diagnostic potentia; ANNALS OF THE NEW YORK ACADEMY OF SCIENCE, 1026:1-4.
2. Alves PI, Martins MP, Semedo T, MarCues JJF, Tenreiro R, Crespo MTB; Comparison of phenotypic and genotypic taxonomic methods for the identification of dairy *enterococci*; ANTONIE VAN LEEUWENHOEK INTERNATIONAL JOURNAL OF GENERAL AND MOLECULAR MICROBIOLOGY, 85 (3): 237-252 APR 2004.
3. Vinga S, Gouveia-Oliveira R, Almeida JS; Comparative evaluation of word composition distances for the recognition of SCOP relationships; BIOINFORMATICS, 20 (2): 206-215 JAN 22 2004.
4. Cunha AE, Clemente JJ, Gomes R, Pinto F, Thomaz M, Miranda S, Pinto R, Moosmayer D, Donner P, Carrondo MJT; Methanol induction optimization for scFv antibody fragment production in *Pichia pastoris*; BIOTECHNOLOGY AND BIOENGINEERING, 86 (4): 458-467 MAY 20 2004.
5. Silva M, Cruz H, Rossetti O, Arese A, Oliva A; Development of an optical immunosensor based on the fluorescence of Cyanine-5 for veterinarian diagnostics; BIOTECHNOLOGY LETTERS, 26 (12): 993-997 JUN 2004.
6. Rebelo LPN, Najdanovic-Visak V, Visak ZP, da Ponte MN, Szydlowski J, Cerdeirina CA, Troncoso J, Romani L, Esperanca JMSS, Guedes HJR, de Sousa HC; A detailed thermodynamic analysis of [C(4)mim][BF4] plus water as a case study to model ionic liCuid aqueous solutions; GREEN CHEMISTRY, 6 (8): 369-381 2004.
7. Rohrer B, Pinto FR, Hulse KE, Lohr HR, Zhang L, Almeida JS; Multidestructive pathways triggered in photoreceptor cell death of the RD mouse as determined through gene expression profiling; JOURNAL OF BIOLOGICAL CHEMISTRY, 279 (40): 41903-41910 OCT 1 2004.
8. Maranga L, Cunha A, Clemente J, Cruz P, Carrondo MJT; Scale-up of virus-like particles production: effects of sparging, agitation and bioreactor scale on cell growth, infection kinetics and productivity; JOURNAL OF BIOTECHNOLOGY, 107 (1): 55-64 JAN 8 2004.
9. Duarte ARC, Coimbra P, de Sousa HC, Duarte CMM; Solubility of flurbiprofen in supercritical carbon dioxide; JOURNAL OF CHEMICAL AND ENGINEERING DATA, 49 (3): 449-452 MAY-JUN 2004.
10. de Azevedo RG, Szydlowski J, Pires PF, Esperanca JMSS, Guedes HJR, Rebelo LPN; A novel non-intrusive microcell for sound-speed measurements in liCuids. Speed of sound and thermodynamic properties of 2-propanone at pressures up to 160 MPa; JOURNAL OF CHEMICAL THERMODYNAMICS, 36 (3): 211-222 MAR 2004.
11. de Sousa ARS, Raeissi S, Aguiar-Ricardo A, Duarte CMM, Peters CJ; High pressure phase behavior of the system ethane plus orange peel oil; JOURNAL OF SUPERCRITICAL FLUIDS, 29 (1-2): 59-67 APR 2004.
12. Vinga S, Almeida JS; Renyi continuous entropy of DNA sequences; JOURNAL OF THEORETICAL BIOLOGY, 231 (3): 377-388 DEC 7 2004.
13. Carmo M, Peixoto C, Coroadinha AS, Alves PM, Cruz PE, Carrondo MJT; Quantitation of MLV-based retroviral vectors using real-time RT-PCR; JOURNAL OF VIROLOGICAL METHODS, 119 (2): 115-119 AUG 2004.
14. Horie K, Baron M, Fox RB, (...), Rebelo LP, *et al*; Definitions of terms relating to reactions of polymers and to functional polymeric materials - (IUPAC Recommendations 2003); PURE AND APPLIED CHEMISTRY, 76 (4): 889-906 APR 2004
15. Jorge PAS, Caldas P, Rosa CC, Oliva AG, Santos JL; Optical fiber probes for fluorescence based oxygen sensing; SENSORS AND ACTUATORS B-CHEMICAL, 103 (1-2): 290-299 SEP 29 2004.

2005

1. Branco LC, Serbanovic A, da Ponte MN, Afonso CAM; Clean osmium-catalyzed asymmetric dihydroxylation of olefins in ionic liquids and supercritical CO₂ product recovery; CHEMICAL COMMUNICATIONS, (1): 107-109 2005
2. Leitao MC, MarCues AP, San Romão MV; A survey of biogenic amines in commercial Portuguese wines; FOOD CONTROL, 16 (3): 199-204 MAR 2005
3. Oliveira R, Clemente JJ, Cunha AE, Carrondo MJT; Adaptive dissolved oxygen control through the glycerol feeding in a recombinant *Pichia pastoris* cultivation in conditions of oxygen transfer limitation; JOURNAL OF BIOTECHNOLOGY, 116 (1): 35-50 MAR 2 2005
4. Duarte ARC, Santiago S, de Sousa HC, Duarte CMM; Solubility of acetazolamide in supercritical carbon dioxide in the presence of ethanol as a cosolvent; JOURNAL OF CHEMICAL AND ENGINEERING DATA, 50 (1): 216-220 JAN-FEB 2005
5. Santos SS, Fonseca LL, Monteiro MAR, Carrondo MJT, Alves PM; Culturing primary brain astrocytes under a fully controlled environment in a novel bioreactor; JOURNAL OF NEUROSCIENCE RESEARCH, 79 (1-2): 26-32 JAN 1 2005

In Press

1. Brito MD, Delgado AM, Catulo L, Cuintans F, Peres C; The role of bacteriocin producers in table-olive fermentation; ACTA HORTICULTURAE.
2. Domingues H, Peres C, Monteiro OR, Pedra F, Catulo L, Martins JC, Leitão F, Vilar MT; Effects of Irrigation with Olive Mill Wastewater on Some Soil Characteristics; ACTA HORTICULTURAE.
3. Serrano C, Damaso A, Brito MD, Delgado AM, Peres C; Bacteriocin diversity among lab from table-olives; ACTA HORTICULTURAE.
4. Bronze MR, Catulo L, Vilas-Boas L, Peres C; Use of *Lactobacillus plantarum* in treatments of olive mill wastewater; ACTA HORTICULTURAE.
5. Pinto FR, Cowart LA, Hannun YA, Rohrer B, Almeida JS; Local correlation of expression profiles with gene annotations - proof of concept for a general conciliatory method; Bioinformatics 2004 Oct 28 [Epub ahead of print]
6. Voit, EO, JS Almeida; Decoupling Dynamical Systems for Pathway Identification from Metabolic Profiles; Bioinformatics.
7. Chammem N, Kachouri M, Mejri M, Peres C, Boudabous A, Hamdi M; Combined effect of alkali pretreatment and sodium chloride addition on the olive fermentation process; BIORESOURCE TECHNOLOGY.
8. Duarte ARC, Sampaio de Sousa AR, de Sousa HC, Gil MHM, Jespersen HT, Duarte CMM; Solubility of dense carbon dioxide in two biocompatible acrylate copolymers "S"; BRAZILIAN JOURNAL OF CHEMICAL ENGINEERING.
9. Gilmer, JF, Simplício, AL, Clancy, JM; A new amino-masking group capable of pH-triggered amino-drug release; EUROPEAN JOURNAL OF PHARMACEUTICAL SCIENCES.
10. Delgado A, Brito D, Peres C, Noé-Arroyo F, Garrido-Fernández A; Bacteriocin production by *Lactobacillus pentosus* B96 can be expressed as a function of temperature and NaCl concentration; FOOD MICROBIOLOGY.
11. Ferreira TB, Alves PM, Aunins JG, Carrondo MJT; Use of adenoviral vectors as veterinary vaccines; GENE THERAPY.
12. Souza APB, Carvalhal AV, Peixoto CC, Maranga L, Moraes RHP, Mendonça RZM, Pereira CA, Carrondo MJT, Mendonça RZ; Purification and characterization of an anti-apoptotic protein isolated from *Lonomia obliqua* hemolymph; JOURNAL OF BIOTECHNOLOGY.
13. Lopes MFS, Simões AP, Tenreiro R, MarCues JJF, Barreto Crespo MT; Activity and expression of a virulence factor, gelatinase, in dairy *enterococci*; INTERNATIONAL JOURNAL OF FOOD MICROBIOLOGY.

14. Ribeiro T, Abrantes M, Lopes MFS, Tenreiro R, Barreto Crespo MT; Vancomycin resistance in dairy and clinical enterococcal isolates from Portugal: proof of dissemination of Tn1546; INTERNATIONAL JOURNAL OF FOOD MICROBIOLOGY.
15. Lopes MFS, Ribeiro T, Abrantes M, MarCues JFF, Tenreiro R, Barreto Crespo MT; Antimicrobial Resistance Profiles of Dairy and Clinical Isolates and Type Strains of *Enterococci*; INTERNATIONAL JOURNAL OF FOOD MICROBIOLOGY.
16. Szydlowski J, Gomes de Azevedo R, Rebelo LPN, Esperança JMSS, Guedes HJR; Deuterium isotope differences in N₂-PROPANONE, (CH₃)₂CO/(CD₃)₂CO: A high-pressure sound-speed, density, and heat capacities study; JOURNAL OF CHEMICAL THERMODYNAMICS 37.
17. Serrano I, Melo-Cristino J, Carriço J, Ramirez M; Characterization of the genetic lineages responsible for pneumococcal invasive disease in Portugal; JOURNAL OF CLINICAL MICROBIOLOGY.
18. Delgado A, Brito D, Fevereiro P, Tenreiro R, Peres C; Bioactivity Quantification of crude bacteriocin solutions; JOURNAL OF MICROBIOLOGICAL METHODS.
19. Guedes HJ, Cordeiro TC, Lopes JNC, Esperança JMSS, Rebelo LPN, HuC S, Seddon KR; Deviations from ideality in mixtures of two ionic liquids containing a common ion; JOURNAL OF PHYSICAL CHEMISTRY B, 109.
20. Duarte ARC, Anderson L, Duarte CMM, Kazarian SG; A comparison between gravimetric and in-situ spectroscopic methods to measure the sorption of CO₂ in P(MMA-EHA-EGDMA); JOURNAL OF SUPERCRITICAL FLUIDS.
21. Mueller M, Wagner CL, Annibale DJ, Hulsey TC, Knapp RG, Almeida JS; Predicting Extubation Outcome in Preterm Newborns: a Comparison of Neural Networks with Clinical Expertise and Statistical Modeling; PEDIATRIC RESEARCH.
22. Pina C, Pinto FR, Feijó JA, Becker JD; A genomic view of the commitment to cell growth, cell division control and regulation of gene expression in Arabidopsis pollen; PLANT PHYSIOLOGY.
23. Duarte ARC, Martins C, Coimbra P, Gil MHM, de Sousa HC, Duarte CMM; Sorption and Diffusion of Supercritical Carbon Dioxide in P(MMA-EHA-EGDMA); POLYMER.
24. Peixoto CC, Marcelino I, Sousa MQ, Vachiéry N, Bensaid A, Martinez D, Carrondo MJT, Alves PM; Quantification of *Ehrlichia ruminantium* by Real Time PCR; VETERINARY MICROBIOLOGY.

BOOK CHAPTERS

2004

1. Imre AR, D-Rzoska A, Kraska T, Martinas K, Rebelo LPN, Rzoska SJ, Visak ZP, Yelash LV; Phase Equilibrium in Complex Liquid under negative pressure; in "Non-Linear Dielectric Phenomena in Complex Liquids", Eds.: S.J. Rzoska, V. Zhelezny; NATO Science Series, II – Mathematics, Physics and Chemistry, Vol. 157, Kluwer-Springer Publishers, Dordrecht, pp. 169-181, 2004.
2. de Sousa HC, Rebelo LPN; Equilíbrio líquido-líquido de soluções de polímeros; in "Química de Polímeros", Eds.: JSS de Melo, MJ Moreno, HD Burrows, MH Gil, Imprensa da Universidade de Coimbra, Coimbra, pp. 217-249, 2004

In Press

3. Rebelo LPN, Najdanovic-Visak V, Gomes de Azevedo R, Esperança JMSS, Nunes da Ponte M, Guedes HJR, Visak ZP, de Sousa HC, Szydlowski J, Canongia Lopes JN, Cordeiro TC; Phase behaviour and thermodynamic. Properties of ionic liquids, ionic liquid mixtures and ionic liquid solutions; Chapter 21 in Ionic Liquids III: Fundamentals, Progress, Challenges, and Opportunities, eds. R. Rogers and K.R. Seddon, American Chemical Society Symp. Ser. Vol. 901, 00-00, (2005).
4. Cerdeirina CA, Troncoso J, Paz Ramos C, Romani L, Najdanovic-Visak V, Esperança JMSS, Nunes da Ponte M, Guedes HJR, Visak P, Rebelo LPN; Criticality of the [C4mim][BF₄] + water system; Chapter 13 in Ionic Liquids III: Fundamentals, Progress, Challenges, and Opportunities,

eds. R. Rogers and K.R. Seddon, American Chemical Society Symp. Ser. Vol. 901, 00-00, (2005).

5. Najdanovic-Visak V, Serbanovic A, Esperança JMSS, Guedes HJR, Rebelo LPN, Nunes da Ponte M; Multiphase equilibrium in mixtures of [C4mim][PF6] with supercritical carbon dioxide, water and ethanol applications in catalysis; Chapter 23 in Ionic Liquids III: Fundamentals, Progress, Challenges, and Opportunities, eds. R. Rogers and K.R. Seddon, American Chemical Society Symp. Ser. Vol. 901, 00-00, (2005).

OTHER PUBLICATIONS

1. Carrondo, MJ; Aunins, JG; Biochemical engineering - Editorial overview; CURRENT OPINION IN BIOTECHNOLOGY, 15 (5): 441-443 OCT 2004; Editorial Material.
2. Oliveira M, Brito D, Catulo L, Silva TB, Pereira S, Leitão F, Gomes L, Silva S, Peito A, Fernandes I, Gordo F, Peres C; Biotechnology of Olive Fermentation of Galega Portuguese Variety; GRASAS Y ACEITES 55(3).

PLANT SCIENCES DIVISION

ISI Papers

2004

1. Neves SS, Watson MF; Phylogenetic relationships in Bupleurum (Apiaceae) based on nuclear ribosomal DNA ITS sequence data; ANNALS OF BOTANY, 93 (4): 379-398 APR 2004; (Review)
2. Cerasoli S, Maillard P, Scartazza A, Brugnoli E, Chaves MM, Pereira JS; Carbon and nitrogen winter storage and remobilisation during seasonal flush growth in two-year-old cork oak (*Quercus suber* L.) saplings; ANNALS OF FOREST SCIENCE, 61 (7): 721-729 OCT-NOV 2004.
3. Marum L, Estevao C, Oliveira MM, Amancio S, Rodrigues L, Miguel C; Recovery of cryopreserved embryogenic cultures of maritime pine - Effect of cryoprotectant and suspension density; CRYOLETTERS, 25 (5): 363-374 SEP-OCT 2004.
4. Vaz Patto MV, Satovic Z, Pego S, Feveiro P; Assessing the genetic diversity of Portuguese maize germplasm using microsatellite markers; EUPHYTICA, 137 (1): 63-72 Sp. Iss. SI 2004.
5. Vaz AC, Pinheiro C, Martins JMN, Ricardo CPP; Cultivar discrimination of Portuguese *Lupinus albus* by seed protein electrophoresis: the importance of considering "glutelins" and glycoproteins; FIELD CROPS RESEARCH, 87 (1): 23-34 APR 15 2004.
6. Gemas VJV, Almadanim MC, Tenreiro R, Martins A, Feveiro P; Genetic diversity in the Olive tree (*Olea europaea* L. subsp *europaea*) cultivated in Portugal revealed by RAPD and ISSR markers; GENETIC RESOURCES AND CROP EVOLUTION, 51 (5): 501-511 AUG 2004.
7. Ribeiro AC, Teixeira AR, Ferreira RB; Characterization of globulins from common vetch (*Vicia sativa* L.); JOURNAL OF AGRICULTURAL AND FOOD CHEMISTRY, 52 (15): 4913-4920 JUL 28 2004.
8. Freitas RL, Teixeira AR, Ferreira RB; Characterization of the proteins from *Vigna unguiculata* seeds; JOURNAL OF AGRICULTURAL AND FOOD CHEMISTRY, 52 (6): 1682-1687 MAR 24 2004.
9. Chaves MM, Oliveira MM; Mechanisms underlying plant resilience to water deficits: prospects for water-saving agriculture; JOURNAL OF EXPERIMENTAL BOTANY, 55 (407): 2365-2384 NOV 2004.
10. de Carvalho MHC, Pham-Thi AT, Gareil M, d'Arcy-Lameta A, Fodil YZ; Isolation and characterization of an aspartic proteinase gene from cowpea (*Vigna unguiculata* L. Walp.); JOURNAL OF PLANT PHYSIOLOGY, 161 (8): 971-976 AUG 2004.
11. Pinheiro C, Passarinho JA, Ricardo CP; Effect of drought and rewatering on the metabolism of *Lupinus albus* organs; JOURNAL OF PLANT PHYSIOLOGY, 161 (11): 1203-1210 NOV 2004.
12. Miguel C, Gonçalves S, Tereso S, Marum L, Maroco J, Oliveira MM; Somatic embryogenesis from 20 open-pollinated families of Portuguese plus trees of maritime pine; PLANT CELL TISSUE AND ORGAN CULTURE, 76 (2): 121-130 FEB 2004.

13. Araujo SD, Duque ASRLA, dos Santos DMMF, Fevereiro MPS; An efficient transformation method to regenerate a high number of transgenic plants using a new embryogenic line of *Medicago truncatula* cv. Jemalong; PLANT CELL TISSUE AND ORGAN CULTURE, 78 (2): 123-131 AUG 2004.
14. Duque ASRLA, Araujo SD, dos Santos DMMF, Fevereiro MPS; Optimisation of a selection scheme using kanamycin to improve transformation of *Medicago truncatula* cv. Jemalong; PLANT CELL TISSUE AND ORGAN CULTURE, 78 (3): 277-280 SEP 2004.
15. Vatulescu AD, Fortunato AS, Sa MC, Amancio S, Ricardo CPP, Jackson PA; Cloning and characterisation of a basic IAA oxidase associated with root induction in *Vitis vinifera*; PLANT PHYSIOLOGY AND BIOCHEMISTRY, 42 (7-8): 609-615 JUL-AUG 2004.
16. Svistoonoff S, Laplaze L, Liang JS, Ribeiro A, Gouveia MC, Auguy F, Fevereiro P, Franche C, Bogusz D; Infection-related activation of the cg12 promoter is conserved between actinorhizal and legume-rhizobia root nodule symbiosis; PLANT PHYSIOLOGY, 136 (2): 3191-3197 OCT 2004.
17. Cerasoll S, Scartazza A, Brugnoli E, Chaves MM, Pereira JS; Effects of partial defoliation on carbon and nitrogen partitioning and photosynthetic carbon uptake by two-year-old cork oak (*Quercus suber*) saplings; TREE PHYSIOLOGY, 24 (1): 83-90 JAN 2004.
18. Ferreira RB, Monteiro SS, Picarra-Pereira MA, Teixeira AR; Engineering grapevine for increased resistance to fungal pathogens without compromising wine stability; TRENDS IN BIOTECHNOLOGY, 22 (4): 168-173 APR 2004; (Editorial Material)

2005

1. Leitao MC, Marques AP, San Romão MV; A survey of biogenic amines in commercial Portuguese wines; FOOD CONTROL, 16 (3): 199-204 MAR 2005.
2. Grant, OM, Incoll LD; Photochemical efficiency is an important component of ecophysiological variation of *Cistus albidus* between habitats in south-east Spain; FUNCTIONAL PLANT BIOLOGY 32 (2) 2005.
3. Campos A, Rijo-Johansen MJ, Carneiro MF, Fevereiro PS; Purification and preliminary characterisation of Adenosine nucleosidase from *Coffea arabica* young leaves; PHYTOCHEMISTRY 66 147–151 2005.
4. Santos PAG, Figueiredo AC, Oliveira MM, Barroso JG, Pedro LG, Deans AG, Scheffer AJC; Growth and essential oil composition of hairy root cultures of *Levisticum officinale* W.D.J. Koch (lovage); Plant Science, 168: 1089-1096 2005.

In Press

1. Centritto M, Wahbi S, Serraj R, Chaves, MM; Effects of partial rootzone drying (PRD) on adult olive tree (*Olea europaea*) in field conditions under arid climate. Photosynthetic responses II; AGRICULTURE, ECOSYSTEMS & ENVIRONMENT.
2. Souza CR, Maroco J, Santos T, Rodrigues ML, Lopes C, Pereira JS, Chaves MM; Control of stomatal aperture and carbon uptake by deficit irrigation in two grapevine cultivars; AGRICULTURE, ECOSYSTEMS & ENVIRONMENT.
3. Pinto MP, Ribeiro A., Regalado A.P, Rodrigues-Pousada C, Ricardo, CPP; Expression of *Lupinus albus* PR-10 during root and leaf development; BIOLOGY PLANTARUM.
4. Osório ML, Breia E, Rodrigues A, Osório J, Le Roux X, Daudet FA, Ferreira I, Chaves MM; Limitations to carbon assimilation by mild drought in nectarine trees growing under field conditions; ENVIRONMENTAL AND EXPERIMENTAL BOTANY.
5. Vaz Patto MC, Skiba B, Pang ECK, Ochatt, SJ, Lambein F, Rubiales D; Lathyrus improvement for resistance against biotic and abiotic stresses: from classical breeding to marker assisted selection; EUPHYTICA.
6. Castilho A, Cunha M, Afonso A, Morais-Cecílio L, Fevereiro P, Viegas W; Genomic characterization and physical mapping of two fucosyltransferase genes in *Medicago truncatula*; GENOME (GJ0402).
7. Carvalho LC, Esquivel MG, Martins I, Ricardo CP, Amâncio S; Monitoring the stability of Rubisco in micropropagated grapevine (*Vitis vinifera* L) by two dimensional electrophoresis; JOURNAL OF PLANT PHYSIOLOGY.

8. Baldé JA, Francisco R, Queiroz A, Regalado AP, Ricardo CP, Veloso MM; Immunolocalization of a class III chitinase in two muskmelon cultivars reacting differently to *Fusarium oxysporum* f sp *melonis*; JOURNAL OF PLANT PHYSIOLOGY.
9. Carvalho IS, Ricardo CPP, Chaves MM; Seeds chemical composition of two lupines (*Lupinus albus* and *Lupinus mutabilis*) influenced by water stress; JOURNAL OF AGRONOMY & CROP SCIENCE.
10. Guevara MA, Changn, D, Almeida, MH, Byrne, M, Collada C, Favre JM, Harvengt L, Jeandroz S, Orazio C, Plomion C, Ramboer A, Rocheta M, Sebastiani F, Soto A, Vendramin G, Gand-Cervera MT; Isolation and characterization of nuclear microsatellite loci in *Pinus pinaster* Ait.; MOLECULAR ECOLOGY NOTES.
11. Neves SS, Swire-Clark G, Hilu KW, Baird WV; Phylogeny of *Eleusine* (Poaceae: Chloridoideae) based on nuclear ITS and plastid trnT-trnF sequences; MOLECULAR PHYLOGENETICS AND EVOLUTION.
12. Pinheiro C, Kehr J, Ricardo CP; Effect of water stress on lupin stem proteins analyzed by two-dimensional gel electrophoresis; PLANTA.
13. Gion J-M, Lalanne C, Le Provost G, Ferry-Dumazet H, Paiva J, Chaumeil P, Frigerio J-M, Brach J, Barré A, de Daruvar A, Claverol S, Bonneau M, Sommerer N, Negroni L, Plomion C; The proteome of maritime pine wood forming tissue; PROTEOMICS.
14. Damesin C, Barbaroux C, Berveiller D, Lelarge C, Chaves MM, Maguas C, Maia R, Pontailier J-Y; The carbon isotope composition of CO₂ respired by trunks: comparison of four sampling methods; RAPID COMMUNICATIONS IN MASS SPECTROMETRY.
15. Gutierrez MV, Vaz Patto MC, Huguet T, Cubero JI, Moreno MT, Torres AM; Cross species amplification of *Medicago truncatula* microsatellites across three major pulse crops; THEORETICAL AND APPLIED GENETICS.
16. Silva C, Garcia-Mas J, Sánchez A M, Arús P, Oliveira MM; Looking into flowering time in almond (*Prunus dulcis* (Mill) D. A. Webb): The candidate gene approach; Theoretical and Applied Genetics.
17. Almeida J, Galego L; Flower symmetry and shape in *Antirrhinum*; INTERNATIONAL JOURNAL OF DEVELOPMENTAL BIOLOGY.

BOOK CHAPTERS

2004

1. Pereira JS, David JS, David TS, Caldeira MC, Chaves MM; Carbon and Water Fluxes in Mediterranean-Type Ecosystems – Constraints and Adaptations; *Progress in Botany* 65, (Eds, Esser, K., Lüttge, U., Beyschlag, W. and Murata, J.) Springer-Verlag, Berlin Heidelberg, pp. 467-498 (2004)
2. Chaves MM, Pereira JS; Plant responses to multiple stresses and the ability to cope with a changing environment; In: M. Reigosa-Roger, N. Pedrol-Bonjoch, and A. Sánchez-Moreiras, (Eds.) *La Ecofisiología Vegetal. Una ciencia de síntesis*. Paraninfo, Thompson, Madrid, Spain
3. Chaves MM, Osório J, Pereira JS; Water use efficiency and photosynthesis; In Bacon, M Ed. 'Water use efficiency in Plant Biology'. Blackwell publ. Oxford. Pp. 42-74. ISBN 1-4051-1434-7 (2004)

2005 and In Press

1. Oliveira MM, Fraser L; Biotechnology of kiwifruit. In: "Biotechnology of Fruit and Nut Crops"; Biotechnology in Agriculture Series, no. 29, (Richard E. Litz, ed.) CAB International Oxfordshire, UK. Pp: 2-27 (2005)
2. Pereira, JS, Chaves MM; Multi-stress responses in *Quercus suber*; In Joffre, R.; Rambal, S., Mooney, H. (Eds.) Mediterranean Oak Woodlands Facing Environmental Changes. Springer Verlag, Berlin.

ISI JOURNALS – 2004/5

JOURNAL TITLE	Nº Papers	Impact Factor
ORGANIC & BIOMOLECULAR CHEMISTRY	1	N.D.
ADVANCES IN MICROBIAL PHYSIOLOGY	1	8,947
CANCER RESEARCH	1	8,649
TRENDS IN BIOTECHNOLOGY	1	7,517
BIOINFORMATICS	1	6,701
JOURNAL OF THE AMERICAN CHEMICAL SOCIETY	1	6,516
JOURNAL OF BIOLOGICAL CHEMISTRY	7	6,482
PLANT PHYSIOLOGY	1	5,634
MOLECULAR MICROBIOLOGY	2	5,563
CELLULAR AND MOLECULAR LIFE SCIENCES	1	4,995
BIOPHYSICAL JOURNAL	4	4,463
BIOCHIMICA ET BIOPHYSICA ACTA-BIOENERGETICS	3	4,431
CHEMISTRY-A EUROPEAN JOURNAL	2	4,353
PROTEINS	3	4,313
JOURNAL OF BACTERIOLOGY	7	4,175
BIOCHEMICAL JOURNAL	3	4,101
BIOCHEMISTRY	3	3,922
JOURNAL OF BIOLOGICAL INORGANIC CHEMISTRY	3	3,905
APPLIED AND ENVIRONMENTAL MICROBIOLOGY	3	3,820
PROTEIN SCIENCE	1	3,787
JOURNAL OF PHYSICAL CHEMISTRY B	4	3,679
FEBS LETTERS	4	3,609
JOURNAL OF CLINICAL MICROBIOLOGY	2	3,489
JOURNAL OF BIOENERGETICS AND BIOMEMBRANES	2	3,424
VIROLOGY	1	3,391
ORGANOMETALLICS	1	3,375
JOURNAL OF ORGANIC CHEMISTRY	2	3,297
JOURNAL OF EXPERIMENTAL BOTANY	1	3,180
PLANTA	1	3,053
MICROBIOLOGY-SGM	2	3,044
JOURNAL OF CHEMICAL PHYSICS	1	2,950
DALTON TRANSACTIONS	3	2,908
BIOCHEMICAL AND BIOPHYSICAL RESEARCH COMMUNICATIONS	1	2,836
GREEN CHEMISTRY	1	2,820
JOURNAL OF PHYSICAL CHEMISTRY A	1	2,792
BIOCHIMICA ET BIOPHYSICA ACTA-GENERAL SUBJECTS	1	2,557
BIOMETALS	1	2,545
JOURNAL OF BIOTECHNOLOGY	1	2,543
EUROPEAN JOURNAL OF INORGANIC CHEMISTRY	2	2,482
SENSORS AND ACTUATORS B-CHEMICAL	1	2,391
MICROBIAL DRUG RESISTANCE-MECHANISMS EPIDEMIOLOGY AND DISEASE	3	2,320
NEW JOURNAL OF CHEMISTRY	2	2,272
JOURNAL OF MOLECULAR CATALYSIS A-CHEMICAL	1	2,264
INTERNATIONAL JOURNAL OF FOOD MICROBIOLOGY	1	2,261
EUROPEAN JOURNAL OF ORGANIC CHEMISTRY	2	2,227
ACTA CRYSTALLOGRAPHICA SECTION D-BIOLOGICAL CRYSTALLOGRAPHY	1	2,208
BIOTECHNOLOGY AND BIOENGINEERING	2	2,173

JOURNAL OF AGRICULTURAL AND FOOD CHEMISTRY	2	2,102
TREE PHYSIOLOGY	2	2,087
JOURNAL OF ORGANOMETALLIC CHEMISTRY	1	2,042
YEAST	1	1,980
JOURNAL OF SUPERCRITICAL FLUIDS	1	1,970
FEMS MICROBIOLOGY LETTERS	1	1,932
ANNALS OF THE NEW YORK ACADEMY OF SCIENCES	1	1,892
HELVETICA CHIMICA ACTA	1	1,861
JOURNAL OF VIROLOGICAL METHODS	1	1,826
FEMS IMMUNOLOGY AND MEDICAL MICROBIOLOGY	1	1,789
PLANT PHYSIOLOGY AND BIOCHEMISTRY	1	1,729
POLYHEDRON	1	1,584
JOURNAL OF THEORETICAL BIOLOGY	1	1,550
CARBOHYDRATE RESEARCH	2	1,533
ANTONIE VAN LEEUWENHOEK INTERNATIONAL JOURNAL OF GENERAL AND MOLECULAR MICROBIOLOGY	1	1,458
PLASMID	1	1,406
ANNALS OF BOTANY, 93 (4): 379-398 APR 2004	1	1,370
JOURNAL OF DAIRY RESEARCH	1	1,209
JOURNAL OF ENVIRONMENTAL MONITORING	1	1,186
JOURNAL OF PLANT PHYSIOLOGY	2	1,149
FIELD CROPS RESEARCH	1	1,027
JOURNAL OF CHEMICAL THERMODYNAMICS	1	0,986
JOURNAL OF CHEMICAL AND ENGINEERING DATA	1	0,950
ANNALS OF FOREST SCIENCE, 61 (7): 721-729 OCT-NOV 2004	1	0,935
PLANT CELL TISSUE AND ORGAN CULTURE	3	0,855
BIOTECHNOLOGY LETTERS, 26 (12): 993-997 JUN 2004	1	0,778
CRYOLETTERS	1	0,775
EUPHYTICA	1	0,705
GENETIC RESOURCES AND CROP EVOLUTION	1	0,573

Total papers 128

Laboratório Associado Lectures 2004-5

- Feb 2004 Profs. Edward Hough and Ole Andreas, Tromso University, Norway
Autosomal Recessive Diseases: the role of phenylalanine hydroxylase and lysosomal á – mannosidase
- Apr 2004 Professor Helen Saibil, Birkbeck College, London. UK.
Organised protein misfolding, the structure and assembly of amyloid fibrils.
- May 2004 The IBET Anniversary Week.
Professor Joachim Klein, GBF Braunschweig, Germany.
Polymeric Biomaterials. An Interdisciplinary Challenge in Science and Technology.
Professor Udo Reichl, MPI, Magdeburg, Germany.
Mathematical Modeling of Influenza A Virus Replication.
Dr. Dana Andersen.
Approaches to Improve Expression of Antibodies and Antibody Fragments.
- May 2004 Dr. Marc Rousset, CNRS, Marseille, France.
Hydrogenases in Desulfovibrio, what for and how do they work?
- Oct 2004 Professor Daniel I.C. Wang. MIT, Cambridge, USA.
Biotechnology of Mammalian Cells: Present Status and Future Perspectives.
- Oct 2004 Dr. Jeff Skinner, University College, London, UK.
Developing Knowledge Transfer Activity and Thinking within a Research-based University.
- Oct 2004 Dr. Liz Harry, University of Sydney, Australia.
How do Bacterial Cells Find their Middle?
- Dec 2004 Dr. Edward Feil, University of Bath, UK
Reconstructing Micro-evolutionary Events in Bacteria.
- Jan 2005 Professor Kelly T. Hughes, University of Washington, Seattle, USA.
Efficient Construction of Molecular Nanomachines: Coupling Flagellar Gene Expression to Assembly in Salmonella.
- Feb 2005 Professor John Hurt, Director of Innovation Partnerships, National Science Foundation, USA
Innovation and Partnerships in Science and Technology

SCAN (Science Conferences at Noon) SEMINARS

Date	14-Jan-2005 (Friday) 12h00
Title	Research at the Protein Biochemistry, Folding and Stability Group
Speaker	Cláudio M. Gomes
Affiliation	Protein Biochemistry, Folding and Stability Group

Date	23-Jan-2003 (Friday) 11h30
Title	Biotechnol Activities
Speaker	Pedro de Noronha Pissarra, Ph.D
Affiliation	Biotechnol, SA

Date	13-Fev-2003 (Friday) 12h00
Title	ECBio- R&D activities
Speaker	Pedro E. Cruz, PhD, MBA
Affiliation	ECBio

Date	20-Fev-2004 (Friday) 12h00
Title	The role of murE gene in the expression of β -lactam antibiotic resistance in methicillin resistant <i>Staphylococcus aureus</i> (MRSA)
Speaker	Susana Gardete
Affiliation	ITQB/The Rockefeller University

Date	27-Fev-2004(Friday) 12h00
Title	Preparation of ophthalmic drug delivery systems, using supercritical fluid technology
Speaker	Catarina Duarte, PhD
Affiliation	IBET

Date	12-Mar-2003 (Friday) 12h00
Title	MS at ITQB
Speaker	Ana Maria Varela Coelho
Affiliation	ITQB Mass Spec.

Date	19-Mar-2003 (Friday) 12h00
Title	Investigating the potential of thermal imaging in monitoring stress in crops and ecosystems
Speaker	Olga Grant
Affiliation	Molecular Ecophysiology

Date	26-Mar-2003 (Friday) 12h00
Title	Modelling protein-protein interactions and electron transfer in the complex between type I and type II cytochromes c_3
Speaker	Vitor Hugo Teixeira
Affiliation	Protein Modelling / Molecular Simulation

Date	16-Apr-2004 (Friday) 12h00
Title	Studies on CotA, an interesting laccase for biotechnological applications
Speaker	Lígia Martins
Affiliation	Microbial and Enzyme Technology

Date	23-Apr-2004 (Friday) 12h00
Title	Structure-function analysis of the <i>Bacillus subtilis</i> transcription factor AraR
Speaker	Irina Franco
Affiliation	Microbial Genetics

Date	30-Apr-2004 (Friday) 12h00
Title	STAB VIDA: services and innovation in life sciences
Speaker	Miguel Santos
Affiliation	STAB VIDA

Date	7-May-2004 (Friday) 12h00
Title	Tricarbonyl Mn(I) and Re(I) complexes with the SPS coordinated: Electrochemistry and Photoisomerisation.
Speaker	Márcia Mora
Affiliation	Theoretical and Inorganic Chemistry Group

Date	14-May-2004 (Friday) 12h00
Title	Regulation of Gene Expression in Response to Hypoxia in <i>Arabidopsis thaliana</i>
Speaker	Cristina Branco Price
Affiliation	Plant Biochemistry

Date	21-May-2004 (Friday) 12h00
Title	Research, Development and Opportunities in Genomics @ RAIZ
Speaker	Cristina Marques
Affiliation	RAIZ

Date	28-May-2004 (Friday) 12h00
Title	Studies of some stereoselective aldol reactions
Speaker	Jorge Wahnon
Affiliation	Organic Synthesis

Date	4-Jun-2004 (Friday) 12h00
Title	Substrate specificity of Penicillin G acylase and the structure determination of <i>vaccinia virus</i> proteins by high-throughput methods
Speaker	Colin McVey
Affiliation	Protein Crystallography

Date	25-Jun-2004 (Friday) 12h00
Title	Molybdenum catalysis in epoxide synthesis
Speaker	Zeljko Petrovski
Affiliation	Organometallic Chemistry Group

Date	08-Jul-2004 (Friday) 12h00
Title	Functional and structural studies on the Sulfur Oxygenase Reductase from <i>Acidianus ambivalens</i>
Speaker	Tim Urich
Affiliation	IMG - Technical University Darmstadt / MX ITQB

Date	16-Jul-2004 (Friday) 12h00
Title	Neuroglobin and Cytochrome b5: two new entries in the hemoglobin superfamily, A crystallographic study
Speaker	Daniele de Sanctis
Affiliation	Department of Physics of the University of Genova / ITQB

Date	23-Jul-2004 (Friday) 12h00
Title	Towards the Enhancement of Trehalose Production in Dairy Bacteria
Speaker	Filipa Cardoso
Affiliation	NMR & Cell Physiology Group

Date	17-Set-2004 (Friday) 12h00
Title	Prodrugs; Amino-masking groups capable of pH-triggered amino-drug release
Speaker	Ana Luisa Simplicio
Affiliation	GLP-IBET / Quality Assurance Unit

Date	1-Oct-2004 (Friday) 12h00
Title	Peroxide regulation of cell wall proteins during leaf wounding in Medicago
Speaker	Nelson Soares
Affiliation	Plant Cell Wall

Date	8-Oct-2004 (Friday) 12h00
Title	Chemical modification of a DOTA - somatostatin analog for diagnosis and therapy of tumours
Speaker	Patricia Antunes
Affiliation	Coordination & Supramolecular Chemistry, ITQB / Basileia University, Suíça

Date	22-Oct-2004 (Friday) 12h00
Title	Strategies of adaptation to high temperature and salinity in hyperthermophilic archaea
Speaker	Luis Gafeira
Affiliation	Cell Physiology and NMR

Date	29-Oct-2004 (Friday) 12h00
Title	Metabolic engineering of Lactococcus lactis: guidelines provided by in vivo NMR
Speaker	Ana Rute Neves
Affiliation	Physiology of acid lactid bacteria & in vivo NMR

Date	05-Nov-2004 (Friday) 12h00
Title	Transformation of Medicago truncatula with arginine decarboxylase gene from Avena sativa to improve drought tolerance
Speaker	Ana Sofia Duque
Affiliation	Plant Cell Biotechnology

Date	12-Nov-2004 (Friday) 12h00
Title	Prodrugs: "Molecular mechanisms underlying adventitious regeneration
Speaker	Margarida Santos
Affiliation	Plant Genetic Engineering

Date	3-Dez-2004 (Friday) 12h00
Title	The Plant Cell Biology Laboratory - Research, Goals (and Dreams)
Speaker	Rita Abranches
Affiliation	Plant Cell Biology Laboratory

Date	10-Dec-2004 (Friday) 12h00
Title	Antibiotic Response Genes and Fitness Genes in Penicillin Resistant <i>Streptococcus pneumoniae</i>
Speaker	Inês Crisóstomo
Affiliation	Molecular Genetics - ITQB / The Rockefeller University

Date	17-Dec-2004 (Friday) 12h00
Title	Rubredoxin:oxygen oxido-reductase from <i>Desulfovibrio gigas</i> - A Bifunctional protein?
Speaker	Rute Rodrigues
Affiliation	Genomics and Stress

SCAN Highlight Seminars

Date	June 18, 2004, 12:00h, Auditorium ITQB
Event	HIGHLIGHT SCAN SEMINAR
Title	Yeast activator proteins (Yaps) and Stress Response: an overview (Plenary Conference, PABMB of the PAN-American Association for Biochemistry and Molecular Biology)
Speaker	Claudina Pousada
Affiliation	ITQB-UNL

Date	September 10, 2004, 12:00h, Auditorium ITQB
Event	SCAN Highlight Seminar
Title	The Vibrational World of Isotope Effects (Adapted from the Plenary Lecture given on the 50th Anniversary of the Gordon Conference, February 2004)
Speaker	Luís Paulo N. Rebelo
Affiliation	ITQB-UNL



SEMINÁRIOS



FISIOLOGIA E BIOLOGIA MOLECULAR DE PLANTAS

ITQB/ISA

1º Seminário

19 de Março de 2004

Auditório do ITQB II

14:30-15:00h

Assinatura do protocolo ITQB/ISA, com a presença dos reitores da UNL e da UTL

15:00-15:40h

Dr. Remy Petit (INRA, Bordéus)

'Evolutionary genetics of Mediterranean oaks and pines.'

15:40-16:00h

Intervalo

16:00-16:40h

Prof. Margarida Oliveira (FCL e ITQB)

'Biotechnology tools for crop improvement - problems and approaches for three portuguese case studies: almond, rice and maritime pine.'

16:40-17:20h

Prof. Leonor Morais (ISA)

'Nuclear dominance as a case-study for disclosing epigenetic processes of genes silencing.'

2º Seminário

7 de Maio de 2004

Sala de Actos do ISA

14:30h

Dr. Jorg Becker (IGC)

'Unveiling the transcriptome of *Arabidopsis thaliana* pollen with full-genome oligonucleotide arrays.'

3º Seminário

4 de Junho de 2004

Sala de Actos do ISA

14:30h

Dr. Philip Jackson (ITQB)

'The extensin network in plant cell walls: an ongoing investigation.'

4º Seminário

9 de Julho de 2004

Auditório do ITQB II

14:30h

Dr. Pedro Talhinhas (ISA)

'Genetic diversity and pathogenicity genes in the olive - *Collectotrichum* interactions.'



CONFERENCES AND COURSES ATTENDED

CHEMISTRY DIVISION

1. XXIX International Symposium on Macrocyclic Compounds (2004 ISMC); Australia, Cairns, July 4-8 2004
2. 11th International Symposium on Solubility Phenomena; Aveiro, Portugal, July 25-29 2004
3. 7th European Biological Inorganic Chemistry Conference (EUROBIC7); Germany, Garmisch-Partenkirchen, August 29 to September 2 2004
4. 14th International Symposium on Homogeneous Catalysis; Germany, Munich, 5 – 9 2004
5. III EuChem Conference on Nitrogen Ligands in Organometallic Chemistry and Homogeneous Catalysis; Italy, Camerino, 8-12 Setembro, 2004
6. 3rd Chianti Electrochemistry Meeting on Metal-containing Molecules; Italy, Pontignano, Siena, 3-9 July, 2004
7. 15th International Conference on Organic Synthesis – IUPAC ICOS 15; Japan, Nagoya, August 1–6, 2004
8. XXXVIth International Conference on Coordination Chemistry (ICCC36); Mexico, Merida, July 18-23 2004
9. Homogenous Catalysis Coimbra Course; Portugal, Coimbra
10. XIX Encontro da Sociedade Portuguesa de Química; Portugal, Coimbra, April 2004
11. Biological oxidants and Antioxidants: a Chemical perspective. A two-weeks course by Prof. K. U. Ingold; Portugal, Faculdade de Ciências da Universidade de Lisboa, October 2004
12. 21th Century Challenges in Radiation Protection and Shielding; Portugal, Funchal, May 9-14, 2004
13. 3rd Portuguese-Spanish Biophysics Congress; Portugal, Lisboa, October 29 – November 1, 2004
14. Quitel 2004; Portugal, Porto, 8-12 Setembro, 2004
15. XIV Congresso Nacional de Bioquímica; Portugal, Vilamoura, December 2-4, 2004
16. 7th International Conference on Fundamental and Applied Aspects of Physical Chemistry; Serbia and Montenegro, Belgrade, September 21-23, 2004,
17. Anual Workshop COST D18,; Spain, Coruña, 23-25 September 2004
18. Inorganic Chemistry EuroConference on New Theoretical and Spectroscopical Approaches to Inorganic Chemistry Problems; Spain, Sant Feliu de Guixols, 4-9 Setembro 2004
19. XXII Reunión del Grupo Especializado de Química Organometálica; Spain, Ciudad Real, Julho 2004
20. XV Spanish-Italian Congress on Thermodynamics of Metal Complexes (SIMEC 2004),; Spain, Huelva, June 23-25 2004
21. 2nd International Symposium on Bioorganometallic Chemistry (ISBOMC II),; Switzerland, Zurich, 2004
22. 12th International Pharmaceutical Technology Symposium; Turkey, Istanbul, , 2004
23. 4th International Post-Graduate Research Symposium on Pharmaceuticals; Turkey, Istanbul, 2004
24. 22nd International Carbohydrate Symposium, SECC; UK, Glasgow, 23-27 July 2004
25. Quantum Mechanics: The no nonsense path to progress; UK, St. John's College, Cambridge, 24-29 Julho, 2004
26. 128th Faraday Discussion "Self-Organising Polymers"; UK, University of Leeds, July 2004
27. Third International Conference on Porphyrins and Phthalocyanines (ICPP-3),; USA, New Orleans, July 11-16, 2004

BIOLOGY DIVISION

1. European Spores Conference; Bratislava, June 17-21, 2004
2. 14th European Congress of Clinical Microbiology and Infectious Diseases; Czech Republic, Prague, May 1-4, 2004
3. 8th PMEN Meeting - Pneumococcal Molecular Epidemiology Network (PMEN); Finland, Helsinki, 12 May, 12, 2004
4. V Journées Francophones de Virologie; France, Paris, April 10-11
5. International Symposium on Propionibacteria & Bifidobacteria: Dairy and Probiotic Applications; France, Saint-Malo, 2-4 June, 2004
6. 2nd International Symposium on RESISTANT GRAM-POSITIVE INFECTIONS; Germany, Berlin, December 10-12, 2004
7. EMBO Conference on Molecular Microbiology: Exploring Prokaryotic Diversity; Germany, Heidelberg, EMBL-European Molecular Biology Laboratory, April 2004
8. Sixth International Meeting on Brain Energy Metabolism; Greece, Heraklion, Crete, 21-24 May, 2004
9. Glycobiology 2004. Joint Meeting of the Society for Glycobiology and the Japanese Society of Carbohydrate Research; Honolulu, November 2004
10. International Conference on Functional Genomics of Gram-Positive Microorganisms; Italy, Baveno, June 22-27
11. 4th International Symposium on Pneumococci and Pneumococcal Diseases (ISPPD); Marina Congress Center, May 9-13, 2004
12. The First International Meeting on Environmental Biotechnology and Engineering (IIMEBE); Mexico, México City, September 2004
13. 29th Meeting FEBS/PABMB; Poland, Warsaw, June 2004.
14. XXXI Jornadas Portuguesas de Genética; Portugal, Oeiras, ITQB/UNL, February 5-6, 2004
15. XIX Encontro da Sociedade Portuguesa de Química; Portugal, Coimbra, 15-16 April, 2004
16. 2nd Annual Meeting of the Portuguese Proteomic Network - ProCura; Portugal, Lisboa, 29th November 2004
17. Ciência e Ética: da Célula ao Embrião; Portugal, Lisboa, Fundação Calouste Gulbenkian, November 26-27, 2004
18. 7^o Congresso Nacional de Pediatria; Portugal, Lisboa, Centro Cultural de Belém, September 23 - 25, 2004
19. Meeting of the Portuguese Society for Biochemistry; Portugal, Lisbon, December, 5-7.
20. Portuguese-Spanish Biophysics Congress; Portugal, Lisbon, . October 29th-November 1st
21. New Advances in Gene Expression and Mutation Analysis; Portugal, Oeiras, Instituto Gulbenkian de Ciência, February 5th, 2004
22. XXXI Jornadas Portuguesas de Genética; Portugal, Oeiras, ITQB/UNL, February 5-6, 2004
23. XXX Annual Meeting, 2004. Lymphocytes: Biology and Medicine, Sociedade Portuguesa de Imunologia; Portugal, Oeiras, September 30 – October 2, 2004
24. Meeting of the Portuguese Society for Microbiology; Portugal, Tomar, November 29-December, 2003
25. XIV Congresso Nacional de Bioquímica; Portugal, Vilamoura, December 2004
26. Meeting of the Portuguese Society for Biochemistry; Portugal, Vilamoura, Dec. 1-3
27. 1st FEMS Congress of European Microbiologists; Slovenia, Ljubljana, June 29-July 3.
28. MICRO-MATRIX: Workshop on Strategies to Address Antimicrobial Resistance Through the Exploitation of Microbial Genomics; Spain, Ávila, Castelo de Magalia, April 2004
29. XX IUPAC Symposium on Photochemistry; Spain, Granada, 17- 22 July, 2004

30. Inauguration Symposium of the new CIB building – Centro de Investigaciones Biológicas. Jornadas Científicas de Inauguración; Spain, Madrid, April 22-23, 2004
31. Workshop on “Understanding Protein Stability”; Sweden, Stockholm, Karolinska Institute, May 8-14, 2004
32. PREVIS “Getting together meeting”; Sweden, Stockholm, February 13-14, 2004
33. The challenges of epidemiological typing of *Staphylococcus aureus* in Europe; The Netherlands, Bilthoven, June 7-8, 2004
34. 11th International Symposium on Staphylococci & Staphylococcal Infections (ISSSI); USA, Charleston, October 24-27, 2004
35. 48th Annual Wind River Conference on Prokaryotic Biology; USA, Aspen Colorado
36. 5th International Conference on Extremophiles; USA, Cambridge, Maryland, 19-23 September, 2004
37. 5th Annual NARSA Investigators Meeting; USA, Charlottesville, Virginia, March 10-11, 2004
38. Meeting on Molecular Genetics of Bacteria and Phage; USA, Cold Spring Harbor, N.Y., August 20-25
39. Conference on Translational Control; USA, New York, Cold Spring Harbor Laboratory, Cold Spring Harbor. September 2004
40. 9th International Conference on Alzheimer's Disease and Related Disorders; USA, Philadelphia, July 2004
41. FASEB 2004 Summer Research Conference on Post-transcriptional Control of Gene Expression: Mechanisms of mRNA Decay; USA, Tucson, Arizona, June, 2004
42. 44th Interscience Conference on Antimicrobials Agents and Chemotherapy (ICAAC); USA, Washington, DC, October 30 – November 2, 2004

BIOLOGICAL CHEMISTRY DIVISION

1. ESRF Users Meeting; France, Grenoble, 10-11 Feb 2004
2. 7th European Biological Inorganic Chemistry Conference; Germany, Garmisch- Partenkirchen, August 29- September 2, 2004
3. 22nd European Crystallographic Meeting; Hungary, Budapest, 26-31 August 2004
4. 13th European Bioenergetics Conference; Italy, Pisa, 21 a 26 de Agosto de 2004
5. 2nd European Meeting “Oxizymes in Naples”; Italy, Naples, June 3-5, 2004
6. 13th European Bioenergetics Conference (EBEC2004); Italy, Pisa, August 2004
7. Annual Meeting Studiegroep Eiwitonderzoek; Netherlands, NWO, LUNTEREN, December 13-14, 2004
8. 29th FEBS Congress; Poland, Warsaw, June 28th – July 1st, 2004
9. Jornadas de Engenharia Biotecnológica; Portugal, Faro, Universidade do Algarve, 3-5 de Março, 2004
10. 3rd Portuguese-Spanish Biophysics Congress; Portugal, Lisboa, October 29 – November 1, 2004
11. Cost Action 847 & D32 workshop; Portugal, Póvoa de Varzim, November 11-12 2004
12. 3rd Recombinant Protein Production Meeting.; Portugal, Tavira, 11-14 Nov, 2004
13. 2004-European Cystic Fibrosis Society Conference "New frontiers in basic science of cystic fibrosis"; Portugal, Tomar, April-May 2004
14. XIV Congresso Nacional de Bioquímica; Portugal, Vilamoura, December 2004
15. European Spores Conference; Slovakia, June 17-20, 2004

16. CCP4 Study Weekend; UK, Leeds, January 2004
17. SPINE Congress 2004; UK, London, 18th October 2004 - 19th October 2004
18. Molecular Graphics and Modelling Society International Meeting 2004 "Towards Accurate calculation of biomolecular recognition and reactivity"; UK, Manchester, September 2004
19. SPINE meeting WP 1+2+3; UK, Oxford, 26th - 27th February 2004
20. Workshop on Molecular Chaperones and Heat- Shock Responses; USA, Cold Spring Harbor, May 2nd -7th 2004
21. Gordon Research Conference: "Environmental Bioinorganic Chemistry"; USA, Maine, 20-25 June 2004
22. Gordon Research Conference: Environmental Bioinorganic Chemistry; USA, Maine, Bates College 2004
23. Gordon Graduate Research Seminar in Bioinorganic Chemistry; USA, Ventura, California, 22-25 Jan. 2004

TECHNOLOGY DIVISION

1. V Encontro Brasileiro de Fluidos Supercriticos; Brasil, Florianópolis, April 2004
2. 14th European Congress of Clinical Microbiology and Infectious Diseases; Czech Republic, Prague, May 1-4, 2004
3. 12th International Biotechnology Meeting; Chile, Santiago de Chile, October 2004
4. XII Annual Congress of the European Society of Gene Therapy; Finland, Tampere, November 2004
5. International Rencontres in Pharmaceutical Engineering; France, Albi, October 2004
6. 6th International Meeting for Brain Energy metabolism: transporters, mitochondria and neurodegeneration; Greece, Heraklion, Crete, May 2004
7. Cell Culture Engineering IX; Mexico, Cancun, March 2004
8. Encontro Nacional de Ciência e Tecnologia 2004, Dinamização de Redes Temáticas de Investigação; Portugal, Universidade de Aveiro Aveiro, 22 e 23 de Outubro de 2004
9. Colóquio XXXII – Valorização do património vitivinícola português pela qualidade, diversidade e segurança alimentar dos seus produtos; Portugal, Estação Vitivinícola Nacional. Dois Portos 2004
10. 22^a International Food Exhibition, session "Alimentos transgênicos, alimentos biológicos, alimentos funcionais. Alimentos seguros?"; Portugal, Associação Nacional de Nutricionistas, Exponor, Leça da Palmeira
11. 6^o Simpósio de Vitivinicultura do Alentejo; Portugal, Évora 2004
12. V Jornadas Técnicas de Engenharia Biotecnológica; Portugal, Instituto Politécnico de Bragança, Bragança 2004
13. XXXI Jornadas de Genética; Portugal, Oeiras, ITQB, 5 e 6 de Fevereiro de 2004.
14. VI Curso Teórico-Prático em Biologia INETI/EZN Molecular,; Portugal, Vale Santarém, Estação Zootécnica Nacional
15. 19th International ICFMH Symposium Food Micro 2004 ; Slovenia, Portoroz, 12-16 September 2004
16. EUROPT(R)ODE VII (7th European Conference on Optical Chemical Sensors and Biosensors); Spain, Madrid, Faculty of Medicine, Complutense University, - April 4-7, 2004
17. Supercritical Clean Technologies for Food Industries and Waste Management; Spain, Cadiz, July, 2004
18. 'EWOFS'04: Second European Workshop on Optical Fiber Sensors', Spain, Santander, June 9 - 11, 2004.

19. IX European Multicolloquim of Parasitology; Spain, Valencia, 18nd – 23th July 2004
20. 3rd European Biotechnology workshop Heterologous Gene Expression in Mammalian Cells, Switzerland, Ittingen, September 2004
21. 5th International symposium on olive growing; Turkey, Ýzmir, 27 September 2 October 2004
22. Symposium on Supercritical Fluids and the Future; UK, Birmingham, 31stMarch-1st April 2004
23. Symposium on Supercritical Fluids and the Future; UK, University of Birmingham, March 2004
24. 11th International Symposium & Exhibit on Supercritical Fluid Chromatography, Extraction, and Processing; USA, Pittsburgh, 1-4 August 2004
25. Gordon Research Conference on Isotopes in Biological and Chemical Sciences (50th Annyversary); USA, Ventura, California, Feb. 15-20, 2004 (Plenary Lecture LPN Rebelo)

PLANT SCIENCES DIVISION

1. 17th EUCARPIA General Congress - Genetic Variation for Plant Breeding ; Austria, Vienna, BOKU - University of Natural Resources and Applied Life Sciences 2004
2. XXXIX Croatian Symposium on Agriculture; Croatia, Opatija, 17-20 February 2004
3. First Croatian Botanical Symposium; Croatia, Zagreb, 30 September-2 October 2004
4. 5th European Conference on Grain Legumes/2nd International Conference on Legume Genomics and Genetics; France, Dijon, 7-11 June 2004.
5. 3rd Plant Genomics European Meetings” (Plant GEMs); France, L yon, 22-25 Sep 2004
6. Congrès de la Société Française d'Electrophorèse et d'Analyse Protéomique. Progrès et perspectives en Protéomique; France, Bordeaux, 14 et 15 Octobre 2004
7. COST Action 843, Working Group 1; Greece, Heraklyon, November 18-21 2004
8. COST 843, WG2 meeting; Hungary, Debrecen, 9-12 Sep. 2004
9. 2nd EPSO Conference Interactions in Plant Biology: Cells, Plants and Communities; Italy, Ischia, 10-14 October 2004
10. X Cell Wall meeting; Italy, Sorrento, Aug. 29-Sep. 3, 2004
11. Conference on challenges and opportunities for sustainable rice based production systems; Italy, Torino, 13 15 September 2004
12. 14th Congress of the Federation of European Societies of Plant Biology; Poland, Cracow, August 2004
13. COST E28, WG2 meeting; Poland, Cracow, 26-27 Aug. 2004
14. Workshop 'Improvement of tolerance to environmental stress and quality in cereals'; Poland, Radzikow, Plant Breeding and Acclimatization Institute, March 25-27 2004
15. II Encontro nacional sobre microssatélites e genética de populações/I Encontro nacional sobre marcadores moleculares; Portugal, Lisboa, 23-24 Sep 2004
16. IUFRO Conference 'Eucalyptus in a changing world'; Portugal, Aveiro, 11-15 Oct., 2004
17. 6^o Simpósio de Vitivinicultura do Alentejo; Portugal, Évora, 26 a 28 de Maio 2004
18. VII Portuguese-Spanish Symposium on 'Plant Water Relations'; Portugal, Faro, 2004
19. X Simpósio Ibérico de Nutrição Mineral de Plantas; Portugal, Lisboa, 21-24 Setembro 2004
20. 2nd Annual Meeting of the Portuguese Proteomic Network – PROCURA: “New Frontiers in Proteomics Technology”; Portugal, Lisboa, Instituto Nacional de Saúde Ricardo Jorge, 29 November 2004
21. XXXI Jornadas Portuguesas de Genética; Portugal, Oeiras, ITQB, 5-6 Fevereiro 2004
22. Programa Operacional Agricultura e Desenvolvimento Rural -“Semana Tecnológica”; Portugal, Santarém, Estação Zootécnica Nacional, 17 a 21 de Maio 2004

23. 3rd Recombinant Protein Production Meeting; Portugal, Tavira, 11-14 November 2004
24. XIV Congresso Nacional de Bioquímica; Portugal, Vilamoura, 2-4 Dezembro 2004
25. II Jornades de Fisiologia Vegetal de la Societat Catalana de Biologia; Spain, Barcelona, November 2004
26. Workshop 'Water transport and Aquaporins in Grapevine'; Spain, Maiorca, 21-22 October 2004
27. 9th International Conference on Biotechnology in the Pulp and Paper Industry; South Africa, Durban, 10-14 Oct. 2004
28. 17th FAOBMB Symposium/2nd IUBMB Special Meeting "Genomics and Health in the 21st Century"; Thailand, Bangkok, 22-26 November 2004
29. Annual meeting of the Society of Experimental Biology; UK, Edinburgh, Herriot-Watt University, March 2004
30. 7th International Symposium on 'Grapevine Physiology and Biotechnology'; USA, California, Davies, 21-25 June 2004
31. Botany 2004, Scientific Meeting (Genetics Section, August 4th); USA, Snowbird, Utah, USA Botanical Society of America, ASPT, AFS and ABLs 2004

MEETINGS ORGANIZED BY ITQB RESEARCHERS

1. The First International Meeting on Environmental Biotechnology and Engineering; Mexico, México City, September, 6-8, 2004, CINVESTAV, (C.Arraiano, Member of the International Scientific Committee)
2. 3rd Portuguese-Spanish Biophysics Congress – Lisbon, Portugal, October 29th – November 1st, 2004. Main organizer Cláudio M. Soares
3. BioCrys2004: “Fundamentals of modern methods in biocrystallography”, ITQB, 19-26 November 2004. Main Organizer Maria Arménia Carrondo
4. European Spores Conference. Bratislava, Slovak Republic, June 17-21. Adriano Henriques, Member of the Scientific Committee.
5. IGBP Seminar on ‘Global Change and Sustainability’, 16-17 April. Évora. M Manuela Chaves, Scientific Committee and Chairperson
6. IV Simpósio Ibérico de Maturação e Pós-colheita, 7-10 Outubro. Lisbon, M Manuela Chaves, Scientific Committee and Chairperson
7. XIV Congresso Nacional de Bioquímica. Vilamoura, M Manuela Chaves, Scientific Committee and Chairperson
8. II Encontro Nacional Sobre Microsatélites e Genética de Populações, EAN – Oeiras, 23-24 de Setembro de 2004
9. ISA-ITQB Seminar Series 2004, organized by Rita Abranches (ITQB) and Ricardo Boavida Ferreira (ISA/ITQB)
10. 3rd recombinant protein production meeting: a comparative view on host metabolism, Tavira, Portugal, Novembro 2004. Chairman: Manuel Carrondo, Local Organization Team: Paula M Alves and António Roldão, other team members that attended the meeting: Helena Vieira, Ana Lucia Ferreira, Margarida Serra, Tiago Ferreira, Marcos Sousa, Ana Carina Silva.
11. Dia do Agricultor, tema: Olivicultura – 18 Maio 2004. Estação de Melhoramento de Plantas, Departamento de Olivicultura – Elvas, Portugal, Cidália Peres
12. Sessão Pública de Demonstração do Projecto Antioxidants Naturais, IBET/AESBUC, 26-27 de Outubro, 2004, Catarina Duarte
13. 2nd Annual Meeting of Portuguese Proteomic Network-ProCura-Functional genomics and proteomics”, Lisboa, Portugal, 2004 (Ana Coelho)
14. XXXI Jornadas Portuguesas de Genética”, ITQB; Oeiras, Portugal (5, 6 Feb., 2004) (Organisers: M. Mota, MM Oliveira, AM Sanchez, M Chaves, C Pinto Ricardo, C Arraiano, A Bessa, A Queiroz)
15. EMBO Practical Courses / Gulbenkian Biology Courses: Plant Development: Molecular and Cellular Basis;, IGC, ITQB, Oeiras (22 March-7 April, 2004) (Organizer: José Feijó, IGC/FCUL; Co- Organizer: M.M. Oliveira)
16. MICRO –MATRIX, Strategies to address Antimicrobial Resistance through the exploitation of Microbial Genomics (C.Arraiano); Spain, Ávila, Castle of Magalia, April 17-20, 2004

PH.D. THESES DEFENDED DURING 2004



Carla Maria Alexandre Pinheiro
Lupinus albus reaction to water deficit
23-04-2004
Cândido Pinto Ricardo (Supervisor)
Biologia

Vitória João Valente Gemas
Genetic variability of two woody perennials - *Olea europaea* L. and *Eucalyptus globulus* Labill. - assessed by RAPD and ISSR markers
28-04-2004
Pedro Fevereiro (Supervisor)
Biologia

Vítor Lino Piteira Barnabé de Sousa
Study of the localization of fucosyltransferase III. Importance of the transmembrane and cytosolic domains
08-06-2004
Júlia Costa (Supervisor)
Bioquímica

Zoran Visak
L-L critical loci in heterogeneous mixtures at positive and negative pressures: relation to excess properties of the homogeneous counterpart
22-06-2004
Luís Paulo Rebelo (Supervisor)
Eng^a Química

Dulce Alexandra Alves Lobo da Costa Azevedo
Sensing thiol-reactive compounds by the bZIP transcription factors Yap2 and Yap1 in the yeast *Saccharomyces cerevisiae*
07-07-2004
Claudina Rodrigues-Pousada (Supervisor)
Biologia



Nuno Miguel Formiga Borges
The Role of Mannosylglycerate in Thermo- and Osmo-Adaptation of *Rhodothermus marinus*: Biosynthesis, Regulation and Applications
09-07-2004
Helena Santos (Supervisor)
Bioquímica

Mónica Paula Fernandes Serrano Miranda
Analysis of the σ^G checkpoint during spore development in *Bacillus subtilis*
12-07-2004
Adriano Henriques (Supervisor)
Biologia



Marta Ramilo Abrantes
Organomolybdenum Oxo Catalysts for Sulfoxidation and Olefin Epoxidation
20-07-2004
Carlos Romão (Supervisor)
Química



Cristina Maria da Costa Silva Pereira
Aspects of the extension network in the primary cell wall: kinetic and biochemical approaches to elucidate function
23-07-2004
Philip Jackson (Supervisor)
Bioquímica

Maria Luísa Caramalho Abrunhosa Vasconcelos
Analysis of Dscam and its molecular diversity in axonal targeting of olfactory receptor neurons in *Drosophila*
26-07-2004
IGC - José António Telo (Supervisor)
Biologia



Andreia de Sousa Fernandes
Rhodothermus marinus respiratory chain. Studies and Complexes I and II.
28-09-2004
Miguel Teixeira (Supervisor)
Bioquímica



Claudia Cristina Lage Pereira
Indenyl Complexes of Niobium and Molybdenum: Synthesis, biomedical and catalytic applications
13-10-2004
Carlos Romão (Supervisor)
Química



Vesna Najdanovic-Visak
Phase Behaviour and Thermodynamic Properties of Ionic Liquid Solutions
25-10-2004
Manuel Nunes da Ponte (Supervisor)
Eng^a Química

Zeljko Petrovski
Amine and Imine Complexes of Molybdenum and Iron as Epoxidation Catalysts and Cytostatics
10-11-2004
Carlos Romão (Supervisor)
Química

PROJECTS FUNDED BY FCT

Molecular characterisation of almond genes associated with self-fertility and late flowering	FCT 33499/99	Margarida Oliveira	2000-2004
Molecular analysis of arabinan degradation in <i>Bacillus subtilis</i>	FCT 36212/99	Isabel Sá Nogueira	2000-2004
Molecular evolution and molecular epidemiology of methicillin resistance in <i>Staphylococcus aureus</i>	FCT 34872/99	Hermínia de Lencastre	2000-2004
Metabolism of sulfate reducing bacteria isolated from humans: implications for ulcerative colitis	FCT 36562/99	Inês Cardoso Pereira	2000-2004
Activity against mycobacterium tuberculosis and the mycobacterium avium complex, and immunomodulation by macrocyclic compounds	FCT 35877/99	Rita Delgado	2000-2004
Staphylococi of animal origin: molecular identification, antimicrobial resistance and virulence mechanisms	FCT 34842/99	Hermínia de Lencastre	2000-2004
Diagnosis, isolation and molecular epidemiology of CAEV: A goat retrovirus	FCT 36245/99	Cecília Arraino	2000-2004
Molecular modelling of key redox proteins in bacterial metabolism: methodology and applications	FCT 32789/99	Cláudio Soares	2001-2004
The role of extension peroxidase and extension deposition in plant development	FCT 33201/99	Philip Jackson	2000-2004
Interplay of the transcription factors encoded by yap gene family in stress response	FCT 34967/99	Claudina Rodrigues-Pousada	2001-2004
Characterization of bacteriophage impact and dynamics in natural populations of <i>Streptococcus pneumoniae</i>	FCT 34418/99	Mario Ramirez	2001-2004
Structural, thermodynamic and kinetic bases for energy transduction in an anaerobe: <i>Desulfovibrio desulfuricans</i> ATCC 27774	FCT 35021/99	António V. Xavier	2001-2004
Analysis of an intercellular signalling pathway coupling gene expression to morphogenesis in <i>Bacillus subtilis</i>	FCT 35109/99	Adriano O. Henriques	2000-2004
Molecular basis of protein thermostabilization by hypersolutes	FCT 35131/99	Helena Santos	2001-2004

The role of RNase II and its homologues in the control of gene expression: structural and functional studies	FCT 36155/99	Cecília Arraiano	2000-2004
Structure-function relation of Arabinose binding proteins of <i>Bacillus subtilis</i>	FCT 36164/99	Isabel Sá Nogueira	2000-2004
Symbiotic nitrogen fixation: common features between actinorhizal and legume nodules	FCT 36191/99	Ana Ribeiro	2001-2004
Novel respiratory complexes: molecular basis for energy transduction	FCT 36560/99	Miguel Teixeira	2000-2004
Towards the utilization of cell-reactors for the production of mannosylglycerate, an enzyme stabiliser from hyperthermophiles	FCT 35715/99	Helena Santos	2001-2004
Exploiting metabolic biodiversity: sugar metabolism in the hyperthermophile <i>Archaeoglobus fulgidus</i>	FCT 35719/99	Helena Santos	2001-2004
Bla confers resistance to antibiotics: study of this new target focusing on the control of cell division and protein production	FCT 36203/99	Cecília Arraiano	2001-2004
Mechanisms of iron and oxygen responses in anaerobic prokaryotes	FCT 36558/99	Miguel Teixeira	2001-2004
Non-symmetric macrocycles for metal complexes and supramolecular aggregates with pesticides	FCT 35396/99	Rita Delgado	2001-2004
Experimental and theoretical studies on group 5 and 6 metallocene ring-slippage processes	FCT 36127/99	Carlos Romão	2001-2004
Polymer-surfactant interactions in aqueous solutions: phase diagrams, calorimetry, rheology and dynamics of polymer chains	FCT 35413/99	António Lopes	2001-2004
Dynamic invariance in biological systems	FCT 34794/99	Jonas de Almeida	2001-2004
Phase behavior and microscopic characterisation of micro/macro-emulsions in CO ₂ . New strategies for polymerisation and enzymatic catalysis	FCT 35429/99	Susana Barreiros/ Eurico Melo	2001-2004
Purification, Gene cloning and characterization of plant fucosyltransferases	FCT 35679/99	Pedro Fevereiro	2001-2004
Structure and function of elicitors and their role in the infection of the cork oak by the fungus <i>Phytophthora cinnamomi</i>	FCT 34701/99	Paulo Martel	2001-2004

Production of PHB/PHV CoPolymers by mixed cultures	BIO/35675/99	Helena Santos	2000-2004
Radiopharmaceuticals for treatment of bone cancer pain and/or therapy based on macrocyclic lanthanide complexes	CBO/35859/99	Rita Delgado	2002-2005
Novel rhenium complexes for olefin metathesis and aldehyde olefination: synthesis, characterisation and catalytic studies	QUI/37726/01	Beatriz Royo Cantabrana	2002-2004
Structural and functional mapping of a novel multihaem cytochrome: a model for fumarate reductases	QUI/42902/01	Carlos Alberto Salgueiro	2002-2005
Understanding the intrinsic stability mechanisms of hyperthermophilic metalloproteins	QUI/37521/01	Claúdio Moreira Gomes	2002-2005
Biphasic hydrogenation and oxidation of supercritical carbon dioxide	QUI/38269/01	Manuel N.Ponte	2002-2005
Binding of diatomic molecules to haem proteins	QUI/43435/01	Teresa Catarino	2002-2005
Intramolecular complexes and nanoencapsulation of anthocyanins	QUI/38884/01	António Maçanita	2002-2005
Electron transfer mechanisms and dynamics of a proton thruster: cytochrome c3	QUI/43323/01	Peter Hildebrandt	2002-2004
Approaches to the synthesis of optically pure natural compounds having a dehydrodecalin nucleus	QUI/43313/01	Christopher Maycock	2002-2005
Applications of static mixers in supercritical technology	EQU/41644/01	Manuel N.Ponte	2002-2005
Modelling biomembrane rafts: characterization of the physical-chemical properties of lipid bilayer membranes with raft-like structures	BCI/38861/01	Eurico de Melo	2002-2005
Identification and characterization of proteins involved in Golgi organization from mammalian cells	BCI/38631/01	Júlia Costa	2002-2005
Group A streptococci in the community: molecular epidemiology and clinical relevance	ESP/41971/01	Ilda Sanches	2002-2005
Structure-function studies on novel iron-cluster containing proteins	BME/38859/01	Carlos Frazão	2002-2005
Rnases and polyadenylation in the adjustment of bolA mRNA levels necessary for cells growth and survival	BME/42377/01	Cecília Arraiano	2002-2005
Coat protein mediated resistance against almond llarviruses: strategy and risk assessment	AGR/39095/01	Margarida Oliveira	2002-2005
Adventitious organogenesis in almond: an histological and molecular approach	AGR/38507/01	Ana Sanchez	2003-2006

Molecular basis of the functioning of immobilised redox enzymes in bioelectronic devices	BIO/43105/01	Daniel Murgida	2003-2006
Unravelling the aerobic respiratory chain of the "anaerobic" sulfate reducing bacteria	BME/37406/01	Miguel Teixeira	2003-2006
Genes involved in bioenergetic mechanisms in the sulphate reducing bacterium <i>Desulfovibrio gigas</i>	BME/37480/01	Claudina R. Pousada	2003-2006
Reduction of nitric oxide in prokaryotes: new metabolic routes	BME/44597/02	Miguel Teixeira	2003-2006
Increasing realism in protein modelling: including pH and redox effects into molecular dynamics simulations	BME/45810/02	António Baptista	2003-2006
Structure and function of the centrosomal proteins HsMob in cell division	CBO/39099/01	M ^a Arménia Carrondo	2003-2005
Green processing with ionic liquids coupled to supercritical CO ₂ extraction or membrane pervaporation	EQU/35437/99	Luís Paulo Rebelo	2003-2006
Anaerobic metabolism of the human pathogen <i>Bifidobacterium wadsworthia</i>	ESP/44782/02	Inês Cardoso Pereira	2003-2006
Structure, tropisms and molecular dynamics of the stratum corneum lipid matrix. A study in model systems	QUI/45090/02	Eurico de Melo	2003-2006
Thermodynamics of metalloprotein folding and stability	QUI/45758/02	Cláudio Gomes	2003-2006
Structural characterization of MrkD protein from <i>Klebsiella pneumoniae</i> : implications in the epithelial adhesion properties of the microorganism	ESP/46428/02	Francisco Enguita	2003-2006
Energy transduction in a plant symbiont from <i>Sinorhizobium meliloti</i>	BME/45122/01	Manuela Pereira	2004-2006
Cell wall proteins with roles in xylogenesis programmes in eucalyptus	AGR/46671/02	Philip Jackson	2003-2006
Oxidative Phosphorylation in sulfate respiration	QUI/47866/02	António V. Xavier	2003-2006
Dissection of a checkpoint linking chromosome segregation to asymmetric cell division at the onset of endospore development in <i>Bacillus subtilis</i>	BCI/48647/02	Adriano O. Henriques	2003-2006
Study of ribonucleases from lactic acid bacteria for the construction of strains important for food processing by the dairy industry	AGR/49306/02	Cecília Arraiano	2003-2006
Global experimental approaches to model central metabolism in <i>L. lactis</i> : modulation of the levels of key-enzymes	BIO/48333/02	Helena Santos	2004-2007
Clinical, neurophysiological and neurochemical studies in amyotrophic lateral sclerosis	CBO/43952/02	Júlia Costa	2003-2006

Reforestation with cork oak: genetic variability and seed storage biology	AGG/41359/02	C.Pinto Ricardo		2003-2006
Macrocyclic compounds selective for heavy metals poisoning: Cd(II), Hg(II), and Pb(II)	QUI/49114/02	Rita Delgado		2003-2006
In search of new molecular targets for the development of novel therapeutic strategies for cystic fibrosis	MGI/40878/01	Ana Coelho		2002-2005
New compatible solutes from thermophiles and hyperthermophiles: screening, identification and physiological role	BIO/42331/01	Helena Santos		2003-2006
Searching for rhizobial strains with improved skills to thrive in arid lands	AGG/46371/02	Helena Santos		2004-2007
Folding, processing and function of normal and mutant cystic fibrosis transmembrane conductance regulator: structural implications	MGI/47382/02	Cláudio Soares		2003-2006

PROJECTS FUNDED BY FCG

Functional genomics and high resolution molecular typing of methicillin resistant <i>Staphylococcus aureus</i> (MRSA)	47187/02	Hermínia de Lencastre	44.889	2002-2005
Towards eradication of drug-resistance bacterial disease in a tertiary hospital: mapping reservoirs and transmission routes of methicillin resistant <i>Staphylococcus aureus</i>	55068/02	Hermínia de Lencastre	51.875	2002-2005
Creation of a reference collection of antimicrobial resistant gram-positive bacteria serving the National and International scientific and clinical communities	61052/03	Hermínia de Lencastre	88.000	2004-2006
Infection and colonization by multidrug-resistant Enterococci recovered from neonatal intensive care units. Epidemiological surveillance and infection control	65882	Rosario Labajos	45.124	2004-2007

PROJECTS FUNDED BY THE EUROPEAN COMMISSION

European resistance Intervention study – Reducing resistance in respiratory tract pathogens in children (EURIS)	QLK2-CT-200/01020	Hermínia de Lencastre	473.967	2000-2003
Network for automated bacterial strain fingerprinting in Europe (GENE)	QLK2-CT-2000-01404	Hermínia de Lencastre	7.500	2000-2003
Exploiting new solutes from hyperthermophiles for the preservation of biomaterials: cell factories for production of hypersolutes (HYPER SOLUTES)	QLK3-CT-2000-00640	Helena Santos	228.884	2001-2004

Spore probiotics: an alternative to antibiotics in animal husbandry (SPORE BIOTICS)	QLK5-CT-2001-01729	Adriano Henriques	303.444	2001-2004
Phototrophic biofilms and their potential applications: towards the development of a unifying concept (PHOBIA)	QLK3-CT-2002-01938	Jonas Almeida	151.680	2002-2005
Structural proteomics in Europe (SPINE)	QLG2-CT-2002-00988	M ^a Arménia Carrondo	190.475	2002-2005
Molecular mechanisms of resistance, virulence and epidemicity in <i>Streptococcus pneumoniae</i> (PREVIS)	LSHM-CT-2003-503413	Hermínia de Lencastre	259.810	2004-2006
New applications for compatible solutes from extremophiles (HOTSOLUTIONS)	COOP-CT-2003-508644	Helena Santos	242.520	2004-2007
Signalling and membrane trafficking in transformation and differentiation (SIGNALLING AND TRAFFIC)	LSHG-CT-2004-503228	Júlia Costa	162.700	2004-2007
Water resources strategies and drought alleviation in western Balkan agriculture (WATERWEB)	INCO-CT-2004-509163	Manuela Chaves	113.720	2004-2007
European macromolecular crystallography infrastructure network 2 (MAX-INF2)	505977 (RICA)	M ^a Arménia Carrondo	36.700	2004-2009

ITQB Analytical Services



Mass Spectrometry

The powerful mass spectrometry techniques are fundamental for identification and structural characterization of chemical and biochemical species. In addition to exact mass determination, it is possible to perform controlled fragmentation of the molecular ions, which allows to get detailed structural information.



Contact

Ana Coelho, PhD, Phone: + 351 21 446 94 51/2/07, labms@itqb.unl.pt

Protein Sequencing

Protein Sequencing Service has been working since 1989 and offers a wide range of expertise on protein and peptide N-terminal sequencing, providing other associated services as protein digestions for internal sequencing and protein mapping.



Contact

Maria Manuela Regalla, Phone: + 351 21 446 96 37, mregalla@itqb.unl.pt

Elemental Analysis

The service has a VarioEL Elemental Analyser, which is an automatic instrument that analyses C, H, N, S quantitatively in the original sample.



Contact

Maria da Conceição Almeida, Phone: + 351 21 446 97 44, sae@itqb.unl.pt

Amino Acid Analysis

This facility offers the possibility to analyse physiological fluids, cell culture and fermentation media for free amino acids; protein/peptide hydrolyses for concentration and composition. Some less common amino acids can also be quantitated.



Contact

Paula Chicau, Phone: + 351 21 446 96 38, chicau@itqb.unl.pt

Small Molecule X-ray Crystallography

This X-ray crystallography facility is an analytical service that involves a close collaboration between three different institutions: ITQB, IST and ITN. X-ray diffraction by a single crystal is used to determine the three dimensional structure of small molecules.



Contact

Isabel Bento, PhD, Phone: + 351 21 446 96 62, bento@itqb.unl.pt

CONTACT FOR ACADEMIC INSTITUTIONS OR PUBLIC SERVICES: *Dr.ª Ana Coelho* | Instituto de Tecnologia Química e Biológica - Universidade Nova de Lisboa | Av. da República, Apt.127, 2781-901 Oeiras, PORTUGAL | Phone: + 351 21 446 91 00 / 451 | Fax: + 351 21 441 12 77 | labms@itqb.unl.pt | www.itqb.unl.pt/facilities/services

CONTACT FOR COMPANIES: *Eng. António Ferreira* | Instituto de Biologia Experimental e Tecnológica | Av. da República, Apt.12, 2781-901 Oeiras, PORTUGAL | Phone: + 351 21 446 97 82 | Fax: + 351 21 441 70 62 | antoniof@itqb.unl.pt | www.ibet.pt (*see home page for other IBET analytical services*)

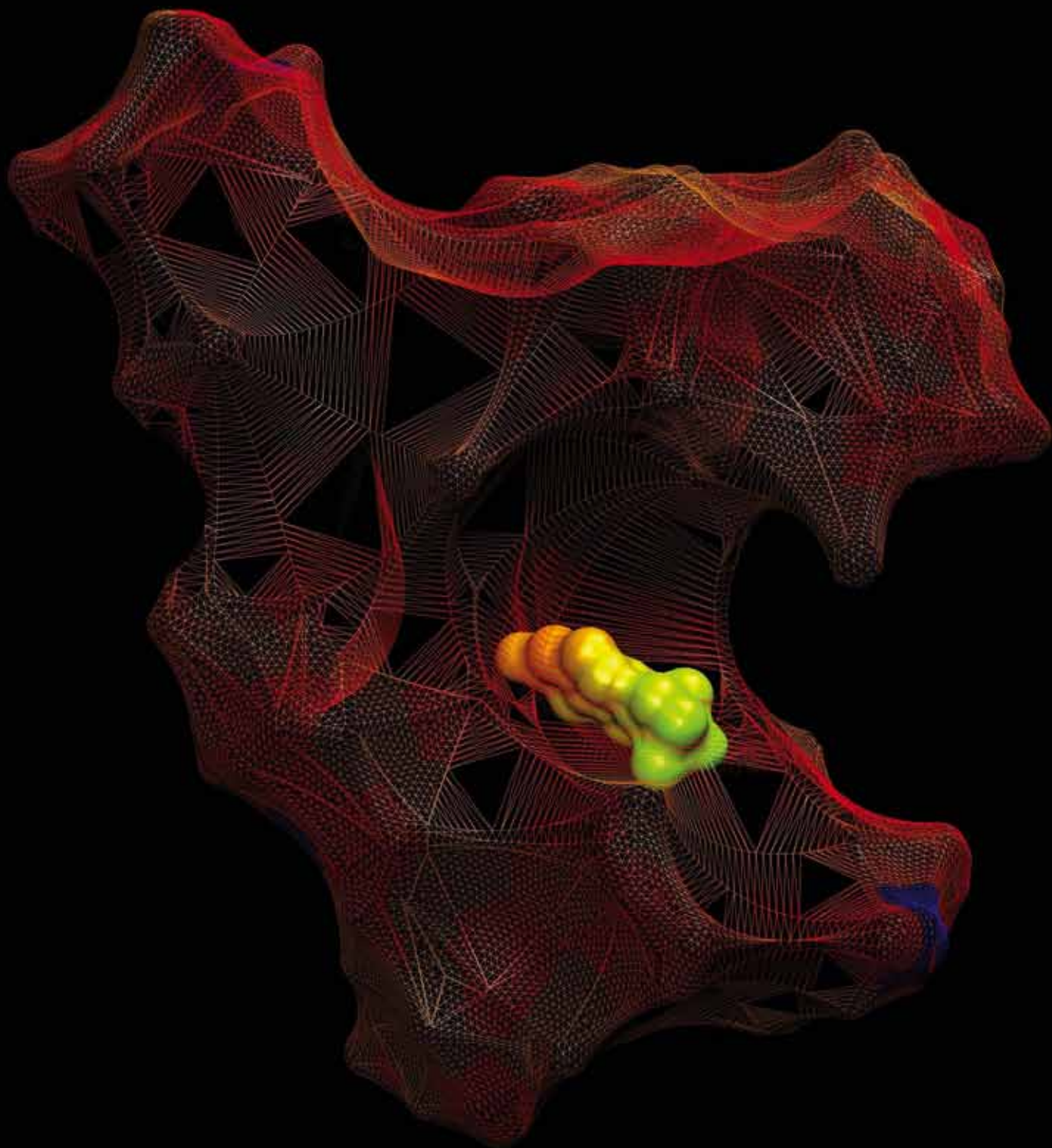

Androgénio

Micaelo, 2004

Representação artística da estrutura do receptor Androgénio humano. O Androgénio e os seus receptores têm um papel importante na fisiologia e patologia nos indivíduos de sexo masculino. Ao Androgénio ligam-se moléculas esteroides tais como a dihidrotestosterona e testosterona, regulando desta forma os genes envolvidos no desenvolvimento e diferenciação masculina (Matias, P.M., 2000, JBC 275:26164).

Human Androgen receptor structure Art work. Androgens and their receptors play an important role in male physiology and pathology. Androgen binds the male sex steroids, dihydrotestosterone and testosterone, and regulates genes for male differentiation and development (Matias, P.M., 2000, JBC 275:26164)